



MATHEMATICS

Exemplar Problems

Class - XII

MATHEMATICS

EXEMPLAR PROBLEMS

Class XII

विद्यया ऽ मृतमश्नुते



एन सी ई आर टी
NCERT

राष्ट्रीय शैक्षिक अनुसंधान और प्रशिक्षण परिषद्
NATIONAL COUNCIL OF EDUCATIONAL RESEARCH AND TRAINING

ISBN 978-93-5007-024-6

**First Edition
January 2010 Magha 1931**

PD 10T BS

**© National Council of Educational
Research and Training, 2010**

Rs 125.00

**Printed on 80 GSM paper with NCERT
watermark**

Published at the Publication Department
by the Secretary, National Council of
Educational Research and Training, Sri
Aurobindo Marg, New Delhi 110 016 and
printed at Kausik Offset Printers, C-34,
Sector 58, Noida 201301

ALL RIGHTS RESERVED

- No part of this publication may be reproduced, stored in a retrieval system or transmitted, in any form or by any means, electronic, mechanical, photocopying, recording or otherwise without the prior permission of the publisher.
- This book is sold subject to the condition that it shall not, by way of trade, be lent, re-sold, hired out or otherwise disposed of without the publisher's consent, in any form of binding or cover other than that in which it is published.
- The correct price of this publication is the price printed on this page, Any revised price indicated by a rubber stamp or by a sticker or by any other means is incorrect and should be unacceptable.

**OFFICES OF THE PUBLICATION
DEPARTMENT, NCERT**

NCERT Campus
Sri Aurobindo Marg
New Delhi 110 016 Phone : 011-26562708

108, 100 Feet Road
Hosdakere Halli Extension
Banashankari III Stage
Bangalore 560 085 Phone : 080-26725740

Navjivan Trust Building
P.O.Navjivan
Ahmedabad 380 014 Phone : 079-27541446

CWC Campus
Opp. Dhankal Bus Stop
Panihati
Kolkata 700 114 Phone : 033-25530454

CWC Complex
Maligaon
Guwahati 781 021 Phone : 0361-2674869

Publication Team

Head, Publication Department : **Peyyeti Rajakumar**

Chief Production Officer : **Shiv Kumar**

Chief Editor : **Shweta Uppal**

Chief Business Manager : **Gautam Ganguly**

Assitant Editor : **Bijnan Sutar**

Production Assistant : **Prakash Veer Singh**

**Cover Design
Shweta Rao**

FOREWORD

The National Curriculum Framework (NCF) – 2005 initiated a new phase of development of syllabi and textbooks for all stages of school education. Conscious effort has been made to discourage rote learning and to diffuse sharp boundaries between different subject areas. This is well in tune with the NPE – 1986 and *Learning Without Burden-1993* that recommend child centred system of education. The textbooks for Classes IX and XI were released in 2006 and for Classes X and XII in 2007. Overall the books have been well received by students and teachers.

NCF–2005 notes that treating the prescribed textbooks as the sole basis of examination is one of the key reasons why other resources and sites of learning are ignored. It further reiterates that the methods used for teaching and evaluation will also determine how effective these textbooks proves for making children’s life at school a happy experience, rather than source of stress or boredom. It calls for reform in examination system currently prevailing in the country.

The position papers of the National Focus Groups on *Teaching of Science, Teaching of Mathematics and Examination Reform* envisage that the mathematics question papers, set in annual examinations conducted by the various Boards do not really assess genuine understanding of the subjects. The quality of question papers is often not up to the mark. They usually seek mere information based on rote memorization, and fail to test higher-order skills like reasoning and analysis, let along lateral thinking, creativity, and judgment. Good unconventional questions, challenging problems and experiment-based problems rarely find a place in question papers. In order to address to the issue, and also to provide additional learning material, the Department of Education in Science and Mathematics (DESM) has made an attempt to develop resource book of exemplar problems in different subjects at secondary and higher-secondary stages. Each resource book contains different types of questions of varying difficulty level. Some questions would require the students to apply simultaneously understanding of more than one chapters/units. These problems are *not* meant to serve merely as question bank for examinations but are primarily meant to improve the quality of teaching/learning process in schools. It is expected that these problems would encourage teachers to design quality questions on their own. Students and teachers should always keep in mind that examination and assessment should test

comprehension, information recall, analytical thinking and problem-solving ability, creativity and speculative ability.

A team of experts and teachers with an understanding of the subject and a proper role of examination worked hard to accomplish this task. The material was discussed, edited and finally included in this source book.

NCERT will welcome suggestions from students, teachers and parents which would help us to further improve the quality of material in subsequent editions.

New Delhi
21 May 2008

Professor Yash Pal
Chairperson
National Steering Committee
National Council of Educational
Research and Training

PREFACE

The Department of Education in Science and Mathematics (DESM), National Council of Educational Research and Training (NCERT), initiated the development of 'Exemplar Problems' in science and mathematics for secondary and higher secondary stages after completing the preparation of textbooks based on National Curriculum Framework–2005.

The main objective of the book on 'Exemplar Problems in Mathematics' is to provide the teachers and students a large number of quality problems with varying cognitive levels to facilitate teaching learning of concepts in mathematics that are presented through the textbook for Class XII. It is envisaged that the problems included in this volume would help the teachers to design tasks to assess effectiveness of their teaching and to know about the achievement of their students besides facilitating preparation of balanced question papers for unit and terminal tests. The feedback based on the analysis of students' responses may help the teachers in further improving the quality of classroom instructions. In addition, the problems given in this book are also expected to help the teachers to perceive the basic characteristics of good quality questions and motivate them to frame similar questions on their own. Students can benefit themselves by attempting the exercises given in the book for self assessment and also in mastering the basic techniques of problem solving. Some of the questions given in the book are expected to challenge the understanding of the concepts of mathematics of the students and their ability to applying them in novel situations.

The problems included in this book were prepared through a series of workshops organised by the DESM for their development and refinement involving practicing teachers, subject experts from universities and institutes of higher learning, and the members of the mathematics group of the DESM whose names appear separately. We gratefully acknowledge their efforts and thank them for their valuable contribution in our endeavour to provide good quality instructional material for the school system.

I express my gratitude to Professor Krishna Kumar, *Director* and Professor G. Ravindra, *Joint Director*, NCERT for their valuable motivation and guidance from time to time. Special thanks are also due to Dr. V. P. Singh, *Reader* in Mathematics, DESM for coordinating the programme, taking pains in editing and refinement of problems and for making the manuscript pressworthy.

We look forward to feedback from students, teachers and parents for further improvement of the contents of this book.

Hukum Singh
Professor and Head

DEVELOPMENT TEAM

EXEMPLAR PROBLEMS – MATHEMATICS

MEMBERS

D.R. Sharma, *Vice Principal*, J.N.V. Mouli, Panchkula, Chandigarh

Hukum Singh, *Professor and Head*, DESM, NCERT, New Delhi

J.C. Nijhawan, *Principal (Retd.)*, Directorate of Education, Delhi

P. K. Jain, *Professor (Retd.)*, Department of Mathematics Delhi University, Delhi

P.K. Chaurasia, *Lecturer*, DESM, NCERT, New Delhi

Ram Avtar, *Professor (Retd.)*, DESM, NCERT, New Delhi

R.P. Maurya, *Reader*, DESM, NCERT, New Delhi

Rahul Sofat, *Lecturer*, Airforce Golden Jubilee Institute, Subroto Park, New Delhi

Reeta Oze, *H.O.D*, Mathematics Section, Army Public School, Dhaula Kuan, New Delhi

Sangeet Arora, *P.G.T.* Apeejay School, Saket, New Delhi

Sunil Bajaj, *Head Mathematics Section*, SCERT, Haryana, Gurgaon,

Sanjay Mudgal, *Lecturer*, DESM, NCERT, New Delhi

MEMBER - COORDINATOR

V.P. Singh, *Reader*, DESM, NCERT, New Delhi

ACKNOWLEDGEMENT

The Council gratefully acknowledges the valuable contributions of the following participants of the Exemplar Problems Workshop:

Ashok Kumar.V, *PGT*, Kendriya Vidyalaya No. 1, Panambur Mangalore, Karnataka; T.Sudha Rani, *PGT*, J.N.V. Pedavegi, West Godavari District (A.P.); Dinesh Dhingra, *PGT*, Delhi Public School Vasundhara Ghaziabad (U.P.); Rajpal Singh, *Lecturer*, Rajkiya Pratibha Vikas Vidyalaya, Gandhi Nagar, Delhi; Dinesh Sharma, *PGT*, Navyug School, Lodhi Road, New Delhi; Anil Kumar Mishra, *Lecturer*, S.S.B.L. Inter College Deoria (U.P.); C.Gurumurthy, Director Academic Rouse Avenue CBSE, New Delhi, Quddus Khan, *Lecturer*, Shibli National College, Azamgarh (U.P.); G.D. Dhall, *Reader (Retd.)* DESM, NCERT, New Delhi and S.N.Yadav, *PGT (Retd.)*, K.V. Andrewsganj, New Delhi.

Special thanks are due to Professor Hukum Singh, *Head*, DESM, NCERT for his support during the development of this book.

The Council also acknowledges the efforts of Deepak Kapoor, *Incharge*, Computer Station; Rakesh Kumar, Surender Kumar and Mrs. Praveen, *DTP Operators*; Abhimanyu Mohanty, *Proof Reader*.

The contribution of APC Office, Administration of DESM, Publication Department and Secretariat of NCERT is also duly acknowledged.

CONTENTS

FOREWORD		<i>iii</i>
PREFACE		<i>v</i>
CHAPTER 1	Relations and Functions	1
CHAPTER 2	Inverse Trigonometric Function	18
CHAPTER 3	Matrices	42
CHAPTER 4	Determinants	65
CHAPTER 5	Continuity and Differentiability	86
CHAPTER 6	Application of Derivatives	117
CHAPTER 7	Integrals	143
CHAPTER 8	Application of Integrals	170
CHAPTER 9	Differential Equations	179
CHAPTER 10	Vector Algebra	204
CHAPTER 11	Three Dimensional Geometry	220
CHAPTER 12	Linear Programming	241
CHAPTER 13	Probability	258
Answers		287
	Design of the Question Paper , <i>Set-I</i>	306
	Design of the Question Paper, <i>Set-II</i>	336

RELATIONS AND FUNCTIONS

1.1 Overview

1.1.1 Relation

A relation R from a non-empty set A to a non empty set B is a subset of the Cartesian product $A \times B$. The set of all first elements of the ordered pairs in a relation R from a set A to a set B is called the domain of the relation R . The set of all second elements in a relation R from a set A to a set B is called the range of the relation R . The whole set B is called the codomain of the relation R . Note that range is always a subset of codomain.

1.1.2 Types of Relations

A relation R in a set A is subset of $A \times A$. Thus empty set ϕ and $A \times A$ are two extreme relations.

- (i) A relation R in a set A is called empty relation, if no element of A is related to any element of A , i.e., $R = \phi \subset A \times A$.
- (ii) A relation R in a set A is called universal relation, if each element of A is related to every element of A , i.e., $R = A \times A$.
- (iii) A relation R in A is said to be reflexive if aRa for all $a \in A$, R is symmetric if $aRb \Rightarrow bRa$, $\forall a, b \in A$ and it is said to be transitive if aRb and $bRc \Rightarrow aRc$ $\forall a, b, c \in A$. Any relation which is reflexive, symmetric and transitive is called an equivalence relation.

 **Note:** An important property of an equivalence relation is that it divides the set into pairwise disjoint subsets called equivalent classes whose collection is called a partition of the set. Note that the union of all equivalence classes gives the whole set.

1.1.3 Types of Functions

- (i) A function $f: X \rightarrow Y$ is defined to be one-one (or injective), if the images of distinct elements of X under f are distinct, i.e.,
$$x_1, x_2 \in X, f(x_1) = f(x_2) \Rightarrow x_1 = x_2.$$
- (ii) A function $f: X \rightarrow Y$ is said to be onto (or surjective), if every element of Y is the image of some element of X under f , i.e., for every $y \in Y$ there exists an element $x \in X$ such that $f(x) = y$.

- (iii) A function $f: X \rightarrow Y$ is said to be one-one and onto (or bijective), if f is both one-one and onto.

1.1.4 Composition of Functions

- (i) Let $f: A \rightarrow B$ and $g: B \rightarrow C$ be two functions. Then, the composition of f and g , denoted by $g \circ f$, is defined as the function $g \circ f: A \rightarrow C$ given by

$$g \circ f(x) = g(f(x)), \quad \forall x \in A.$$

- (ii) If $f: A \rightarrow B$ and $g: B \rightarrow C$ are one-one, then $g \circ f: A \rightarrow C$ is also one-one
 (iii) If $f: A \rightarrow B$ and $g: B \rightarrow C$ are onto, then $g \circ f: A \rightarrow C$ is also onto.

However, converse of above stated results (ii) and (iii) need not be true. Moreover, we have the following results in this direction.

- (iv) Let $f: A \rightarrow B$ and $g: B \rightarrow C$ be the given functions such that $g \circ f$ is one-one. Then f is one-one.
 (v) Let $f: A \rightarrow B$ and $g: B \rightarrow C$ be the given functions such that $g \circ f$ is onto. Then g is onto.

1.1.5 Invertible Function

- (i) A function $f: X \rightarrow Y$ is defined to be invertible, if there exists a function $g: Y \rightarrow X$ such that $g \circ f = I_x$ and $f \circ g = I_y$. The function g is called the inverse of f and is denoted by f^{-1} .
 (ii) A function $f: X \rightarrow Y$ is invertible if and only if f is a bijective function.
 (iii) If $f: X \rightarrow Y$, $g: Y \rightarrow Z$ and $h: Z \rightarrow S$ are functions, then $h \circ (g \circ f) = (h \circ g) \circ f$.
 (iv) Let $f: X \rightarrow Y$ and $g: Y \rightarrow Z$ be two invertible functions. Then $g \circ f$ is also invertible with $(g \circ f)^{-1} = f^{-1} \circ g^{-1}$.

1.1.6 Binary Operations

- (i) A binary operation $*$ on a set A is a function $*$: $A \times A \rightarrow A$. We denote $*(a, b)$ by $a * b$.
 (ii) A binary operation $*$ on the set X is called commutative, if $a * b = b * a$ for every $a, b \in X$.
 (iii) A binary operation $*$: $A \times A \rightarrow A$ is said to be associative if $(a * b) * c = a * (b * c)$, for every $a, b, c \in A$.
 (iv) Given a binary operation $*$: $A \times A \rightarrow A$, an element $e \in A$, if it exists, is called identity for the operation $*$, if $a * e = a = e * a$, $\forall a \in A$.

- (v) Given a binary operation $*$: $A \times A \rightarrow A$, with the identity element e in A , an element $a \in A$, is said to be invertible with respect to the operation $*$, if there exists an element b in A such that $a * b = e = b * a$ and b is called the inverse of a and is denoted by a^{-1} .

1.2 Solved Examples

Short Answer (S.A.)

Example 1 Let $A = \{0, 1, 2, 3\}$ and define a relation R on A as follows:

$$R = \{(0, 0), (0, 1), (0, 3), (1, 0), (1, 1), (2, 2), (3, 0), (3, 3)\}.$$

Is R reflexive? symmetric? transitive?

Solution R is reflexive and symmetric, but not transitive since for $(1, 0) \in R$ and $(0, 3) \in R$ whereas $(1, 3) \notin R$.

Example 2 For the set $A = \{1, 2, 3\}$, define a relation R in the set A as follows:

$$R = \{(1, 1), (2, 2), (3, 3), (1, 3)\}.$$

Write the ordered pairs to be added to R to make it the smallest equivalence relation.

Solution $(3, 1)$ is the single ordered pair which needs to be added to R to make it the smallest equivalence relation.

Example 3 Let R be the equivalence relation in the set \mathbf{Z} of integers given by $R = \{(a, b) : 2 \text{ divides } a - b\}$. Write the equivalence class $[0]$.

Solution $[0] = \{0, \pm 2, \pm 4, \pm 6, \dots\}$

Example 4 Let the function $f : \mathbf{R} \rightarrow \mathbf{R}$ be defined by $f(x) = 4x - 1, \forall x \in \mathbf{R}$. Then, show that f is one-one.

Solution For any two elements $x_1, x_2 \in \mathbf{R}$ such that $f(x_1) = f(x_2)$, we have

$$\begin{aligned} 4x_1 - 1 &= 4x_2 - 1 \\ \Rightarrow 4x_1 &= 4x_2, \text{ i.e., } x_1 = x_2 \end{aligned}$$

Hence f is one-one.

Example 5 If $f = \{(5, 2), (6, 3)\}$, $g = \{(2, 5), (3, 6)\}$, write $f \circ g$.

Solution $f \circ g = \{(2, 2), (3, 3)\}$

Example 6 Let $f : \mathbf{R} \rightarrow \mathbf{R}$ be the function defined by $f(x) = 4x - 3, \forall x \in \mathbf{R}$. Then write f^{-1} .

Solution Given that $f(x) = 4x - 3 = y$ (say), then

$$4x = y + 3$$

$$\Rightarrow x = \frac{y+3}{4}$$

$$\text{Hence } f^{-1}(y) = \frac{y+3}{4} \Rightarrow f^{-1}(x) = \frac{y+3}{4}$$

Example 7 Is the binary operation $*$ defined on \mathbf{Z} (set of integer) by $m * n = m - n + mn \quad \forall m, n \in \mathbf{Z}$ commutative?

Solution No. Since for $1, 2 \in \mathbf{Z}$, $1 * 2 = 1 - 2 + 1 \cdot 2 = 1$ while $2 * 1 = 2 - 1 + 2 \cdot 1 = 3$ so that $1 * 2 \neq 2 * 1$.

Example 8 If $f = \{(5, 2), (6, 3)\}$ and $g = \{(2, 5), (3, 6)\}$, write the range of f and g .

Solution The range of $f = \{2, 3\}$ and the range of $g = \{5, 6\}$.

Example 9 If $A = \{1, 2, 3\}$ and f, g are relations corresponding to the subset of $A \times A$ indicated against them, which of f, g is a function? Why?

$$f = \{(1, 3), (2, 3), (3, 2)\}$$

$$g = \{(1, 2), (1, 3), (3, 1)\}$$

Solution f is a function since each element of A in the first place in the ordered pairs is related to only one element of A in the second place while g is not a function because 1 is related to more than one element of A , namely, 2 and 3.

Example 10 If $A = \{a, b, c, d\}$ and $f = \{a, b\}, (b, d), (c, a), (d, c)\}$, show that f is one-one from A onto A . Find f^{-1} .

Solution f is one-one since each element of A is assigned to distinct element of the set A . Also, f is onto since $f(A) = A$. Moreover, $f^{-1} = \{(b, a), (d, b), (a, c), (c, d)\}$.

Example 11 In the set \mathbf{N} of natural numbers, define the binary operation $*$ by $m * n = g.c.d(m, n)$, $m, n \in \mathbf{N}$. Is the operation $*$ commutative and associative?

Solution The operation is clearly commutative since

$$m * n = g.c.d(m, n) = g.c.d(n, m) = n * m \quad \forall m, n \in \mathbf{N}.$$

It is also associative because for $l, m, n \in \mathbf{N}$, we have

$$\begin{aligned} l * (m * n) &= g.c.d(l, g.c.d(m, n)) \\ &= g.c.d.(g.c.d(l, m), n) \\ &= (l * m) * n. \end{aligned}$$

Long Answer (L.A.)

Example 12 In the set of natural numbers \mathbf{N} , define a relation R as follows: $\forall n, m \in \mathbf{N}, nRm$ if on division by 5 each of the integers n and m leaves the remainder less than 5, i.e. one of the numbers 0, 1, 2, 3 and 4. Show that R is equivalence relation. Also, obtain the pairwise disjoint subsets determined by R .

Solution R is reflexive since for each $a \in \mathbf{N}$, aRa . R is symmetric since if aRb , then bRa for $a, b \in \mathbf{N}$. Also, R is transitive since for $a, b, c \in \mathbf{N}$, if aRb and bRc , then aRc . Hence R is an equivalence relation in \mathbf{N} which will partition the set \mathbf{N} into the pairwise disjoint subsets. The equivalent classes are as mentioned below:

$$\begin{aligned} A_0 &= \{5, 10, 15, 20 \dots\} \\ A_1 &= \{1, 6, 11, 16, 21 \dots\} \\ A_2 &= \{2, 7, 12, 17, 22, \dots\} \\ A_3 &= \{3, 8, 13, 18, 23, \dots\} \\ A_4 &= \{4, 9, 14, 19, 24, \dots\} \end{aligned}$$

It is evident that the above five sets are pairwise disjoint and

$$A_0 \cup A_1 \cup A_2 \cup A_3 \cup A_4 = \bigcup_{i=0}^4 A_i = \mathbf{N}.$$

Example 13 Show that the function $f: \mathbf{R} \rightarrow \mathbf{R}$ defined by $f(x) = \frac{x}{x^2 + 1}, \forall x \in \mathbf{R}$, is

neither one-one nor onto.

Solution For $x_1, x_2 \in \mathbf{R}$, consider

$$\begin{aligned} f(x_1) &= f(x_2) \\ \Rightarrow \frac{x_1}{x_1^2 + 1} &= \frac{x_2}{x_2^2 + 1} \\ \Rightarrow x_1 x_2^2 + x_1 &= x_2 x_1^2 + x_2 \\ \Rightarrow x_1 x_2 (x_2 - x_1) &= x_2 - x_1 \\ \Rightarrow x_1 &= x_2 \text{ or } x_1 x_2 = 1 \end{aligned}$$

We note that there are point, x_1 and x_2 with $x_1 \neq x_2$ and $f(x_1) = f(x_2)$, for instance, if

we take $x_1 = 2$ and $x_2 = \frac{1}{2}$, then we have $f(x_1) = \frac{2}{5}$ and $f(x_2) = \frac{2}{5}$ but $2 \neq \frac{1}{2}$. Hence

f is not one-one. Also, f is not onto for if so then for $1 \in \mathbf{R} \exists x \in \mathbf{R}$ such that $f(x) = 1$

which gives $\frac{x}{x^2+1}=1$. But there is no such x in the domain \mathbf{R} , since the equation $x^2 - x + 1 = 0$ does not give any real value of x .

Example 14 Let $f, g : \mathbf{R} \rightarrow \mathbf{R}$ be two functions defined as $f(x) = |x| + x$ and $g(x) = |x| - x \quad \forall x \in \mathbf{R}$. Then, find $f \circ g$ and $g \circ f$.

Solution Here $f(x) = |x| + x$ which can be redefined as

$$f(x) = \begin{cases} 2x & \text{if } x \geq 0 \\ 0 & \text{if } x < 0 \end{cases}$$

Similarly, the function g defined by $g(x) = |x| - x$ may be redefined as

$$g(x) = \begin{cases} 0 & \text{if } x \geq 0 \\ -2x & \text{if } x < 0 \end{cases}$$

Therefore, $g \circ f$ gets defined as :

For $x \geq 0$, $(g \circ f)(x) = g(f(x)) = g(2x) = 0$

and for $x < 0$, $(g \circ f)(x) = g(f(x)) = g(0) = 0$.

Consequently, we have $(g \circ f)(x) = 0, \forall x \in \mathbf{R}$.

Similarly, $f \circ g$ gets defined as:

For $x \geq 0$, $(f \circ g)(x) = f(g(x)) = f(0) = 0$,

and for $x < 0$, $(f \circ g)(x) = f(g(x)) = f(-2x) = -4x$.

$$\text{i.e. } (f \circ g)(x) = \begin{cases} 0, & x > 0 \\ -4x, & x < 0 \end{cases}$$

Example 15 Let \mathbf{R} be the set of real numbers and $f: \mathbf{R} \rightarrow \mathbf{R}$ be the function defined by $f(x) = 4x + 5$. Show that f is invertible and find f^{-1} .

Solution Here the function $f: \mathbf{R} \rightarrow \mathbf{R}$ is defined as $f(x) = 4x + 5 = y$ (say). Then

$$4x = y - 5 \quad \text{or} \quad x = \frac{y-5}{4}.$$

This leads to a function $g : \mathbf{R} \rightarrow \mathbf{R}$ defined as

$$g(y) = \frac{y-5}{4}.$$

Therefore, $(g \circ f)(x) = g(f(x)) = g(4x + 5)$

$$= \frac{4x+5-5}{4} = x$$

or

$$g \circ f = I_{\mathbf{R}}$$

Similarly

$$(f \circ g)(y) = f(g(y))$$

$$= f\left(\frac{y-5}{4}\right)$$

$$= 4\left(\frac{y-5}{4}\right) + 5 = y$$

or

$$f \circ g = I_{\mathbf{R}}.$$

Hence f is invertible and $f^{-1} = g$ which is given by

$$f^{-1}(x) = \frac{x-5}{4}$$

Example 16 Let $*$ be a binary operation defined on \mathbf{Q} . Find which of the following binary operations are associative

(i) $a * b = a - b$ for $a, b \in \mathbf{Q}$.

(ii) $a * b = \frac{ab}{4}$ for $a, b \in \mathbf{Q}$.

(iii) $a * b = a - b + ab$ for $a, b \in \mathbf{Q}$.

(iv) $a * b = ab^2$ for $a, b \in \mathbf{Q}$.

Solution

(i) $*$ is not associative for if we take $a = 1$, $b = 2$ and $c = 3$, then

$$(a * b) * c = (1 * 2) * 3 = (1 - 2) * 3 = -1 - 3 = -4 \text{ and}$$

$$a * (b * c) = 1 * (2 * 3) = 1 * (2 - 3) = 1 - (-1) = 2.$$

Thus $(a * b) * c \neq a * (b * c)$ and hence $*$ is not associative.

(ii) $*$ is associative since \mathbf{Q} is associative with respect to multiplication.

(iii) $*$ is not associative for if we take $a = 2$, $b = 3$ and $c = 4$, then

$$(a * b) * c = (2 * 3) * 4 = (2 - 3 + 6) * 4 = 5 * 4 = 5 - 4 + 20 = 21, \text{ and}$$

$$a * (b * c) = 2 * (3 * 4) = 2 * (3 - 4 + 12) = 2 * 11 = 2 - 11 + 22 = 13$$

Thus $(a * b) * c \neq a * (b * c)$ and hence $*$ is not associative.

(iv) $*$ is not associative for if we take $a = 1$, $b = 2$ and $c = 3$, then $(a * b) * c = (1 * 2) * 3 = 4 * 3 = 4 \times 9 = 36$ and $a * (b * c) = 1 * (2 * 3) = 1 * 18 = 1 \times 18^2 = 324$.

Thus $(a * b) * c \neq a * (b * c)$ and hence $*$ is not associative.

Objective Type Questions

Choose the correct answer from the given four options in each of the Examples 17 to 25.

Example 17 Let R be a relation on the set \mathbf{N} of natural numbers defined by nRm if n divides m . Then R is

- | | |
|-----------------------------|---|
| (A) Reflexive and symmetric | (B) Transitive and symmetric |
| (C) Equivalence | (D) Reflexive, transitive but not symmetric |

Solution The correct choice is (D).

Since n divides n , $\forall n \in \mathbf{N}$, R is reflexive. R is not symmetric since for $3, 6 \in \mathbf{N}$, $3R6 \neq 6R3$. R is transitive since for n, m, r whenever n/m and $m/r \Rightarrow n/r$, i.e., n divides m and m divides r , then n will divide r .

Example 18 Let L denote the set of all straight lines in a plane. Let a relation R be defined by lRm if and only if l is perpendicular to $m \forall l, m \in L$. Then R is

- | | |
|----------------|-------------------|
| (A) reflexive | (B) symmetric |
| (C) transitive | (D) none of these |

Solution The correct choice is (B).

Example 19 Let \mathbf{N} be the set of natural numbers and the function $f: \mathbf{N} \rightarrow \mathbf{N}$ be defined by $f(n) = 2n + 3 \forall n \in \mathbf{N}$. Then f is

- | | |
|----------------|-------------------|
| (A) surjective | (B) injective |
| (C) bijective | (D) none of these |

Solution (B) is the correct option.

Example 20 Set A has 3 elements and the set B has 4 elements. Then the number of

injective mappings that can be defined from A to B is

- (A) 144 (B) 12
(C) 24 (D) 64

Solution The correct choice is (C). The total number of injective mappings from the set containing 3 elements into the set containing 4 elements is ${}^4P_3 = 4! = 24$.

Example 21 Let $f: \mathbf{R} \rightarrow \mathbf{R}$ be defined by $f(x) = \sin x$ and $g: \mathbf{R} \rightarrow \mathbf{R}$ be defined by $g(x) = x^2$, then $f \circ g$ is

- (A) $x^2 \sin x$ (B) $(\sin x)^2$
(C) $\sin x^2$ (D) $\frac{\sin x}{x^2}$

Solution (C) is the correct choice.

Example 22 Let $f: \mathbf{R} \rightarrow \mathbf{R}$ be defined by $f(x) = 3x - 4$. Then $f^{-1}(x)$ is given by

- (A) $\frac{x+4}{3}$ (B) $\frac{x}{3} - 4$
(C) $3x + 4$ (D) None of these

Solution (A) is the correct choice.

Example 23 Let $f: \mathbf{R} \rightarrow \mathbf{R}$ be defined by $f(x) = x^2 + 1$. Then, pre-images of 17 and -3 , respectively, are

- (A) $\phi, \{4, -4\}$ (B) $\{3, -3\}, \phi$
(C) $\{4, -4\}, \phi$ (D) $\{4, -4, \{2, -2\}\}$

Solution (C) is the correct choice since for $f^{-1}(17) = x \Rightarrow f(x) = 17$ or $x^2 + 1 = 17 \Rightarrow x = \pm 4$ or $f^{-1}(17) = \{4, -4\}$ and for $f^{-1}(-3) = x \Rightarrow f(x) = -3 \Rightarrow x^2 + 1 = -3 \Rightarrow x^2 = -4$ and hence $f^{-1}(-3) = \phi$.

Example 24 For real numbers x and y , define xRy if and only if $x - y + \sqrt{2}$ is an irrational number. Then the relation R is

- (A) reflexive (B) symmetric
(C) transitive (D) none of these

Solution (A) is the correct choice.

Fill in the blanks in each of the Examples 25 to 30.

Example 25 Consider the set $A = \{1, 2, 3\}$ and R be the smallest equivalence relation on A, then $R =$ _____

Solution $R = \{(1, 1), (2, 2), (3, 3)\}$.

Example 26 The domain of the function $f: \mathbf{R} \rightarrow \mathbf{R}$ defined by $f(x) = \sqrt{x^2 - 3x + 2}$ is _____.

Solution Here $x^2 - 3x + 2 \geq 0$
 $\Rightarrow (x - 1)(x - 2) \geq 0$
 $\Rightarrow x \leq 1$ or $x \geq 2$

Hence the domain of $f = (-\infty, 1] \cup [2, \infty)$

Example 27 Consider the set A containing n elements. Then, the total number of injective functions from A onto itself is _____.

Solution $n!$

Example 28 Let \mathbf{Z} be the set of integers and R be the relation defined in \mathbf{Z} such that aRb if $a - b$ is divisible by 3. Then R partitions the set \mathbf{Z} into _____ pairwise disjoint subsets.

Solution Three.

Example 29 Let \mathbf{R} be the set of real numbers and $*$ be the binary operation defined on \mathbf{R} as $a * b = a + b - ab \quad \forall a, b \in \mathbf{R}$. Then, the identity element with respect to the binary operation $*$ is _____.

Solution 0 is the identity element with respect to the binary operation $*$.

State **True** or **False** for the statements in each of the Examples 30 to 34.

Example 30 Consider the set $A = \{1, 2, 3\}$ and the relation $R = \{(1, 2), (1, 3)\}$. R is a transitive relation.

Solution True.

Example 31 Let A be a finite set. Then, each injective function from A into itself is not surjective.

Solution False.

Example 32 For sets A, B and C , let $f: A \rightarrow B, g: B \rightarrow C$ be functions such that $g \circ f$ is injective. Then both f and g are injective functions.

Solution False.

Example 33 For sets A, B and C , let $f: A \rightarrow B, g: B \rightarrow C$ be functions such that $g \circ f$ is surjective. Then g is surjective

Solution True.

Example 34 Let \mathbf{N} be the set of natural numbers. Then, the binary operation $*$ in \mathbf{N} defined as $a * b = a + b, \forall a, b \in \mathbf{N}$ has identity element.

Solution False.

1.3 EXERCISE

Short Answer (S.A.)

1. Let $A = \{a, b, c\}$ and the relation R be defined on A as follows:

$$R = \{(a, a), (b, c), (a, b)\}.$$

Then, write minimum number of ordered pairs to be added in R to make R reflexive and transitive.

2. Let D be the domain of the real valued function f defined by $f(x) = \sqrt{25-x^2}$. Then, write D .
3. Let $f, g: \mathbf{R} \rightarrow \mathbf{R}$ be defined by $f(x) = 2x + 1$ and $g(x) = x^2 - 2, \forall x \in \mathbf{R}$, respectively. Then, find $g \circ f$.
4. Let $f: \mathbf{R} \rightarrow \mathbf{R}$ be the function defined by $f(x) = 2x - 3, \forall x \in \mathbf{R}$. write f^{-1} .
5. If $A = \{a, b, c, d\}$ and the function $f = \{(a, b), (b, d), (c, a), (d, c)\}$, write f^{-1} .
6. If $f: \mathbf{R} \rightarrow \mathbf{R}$ is defined by $f(x) = x^2 - 3x + 2$, write $f(f(x))$.
7. Is $g = \{(1, 1), (2, 3), (3, 5), (4, 7)\}$ a function? If g is described by $g(x) = \alpha x + \beta$, then what value should be assigned to α and β .
8. Are the following set of ordered pairs functions? If so, examine whether the mapping is injective or surjective.
- (i) $\{(x, y): x \text{ is a person, } y \text{ is the mother of } x\}$.
- (ii) $\{(a, b): a \text{ is a person, } b \text{ is an ancestor of } a\}$.
9. If the mappings f and g are given by $f = \{(1, 2), (3, 5), (4, 1)\}$ and $g = \{(2, 3), (5, 1), (1, 3)\}$, write $f \circ g$.
10. Let \mathbf{C} be the set of complex numbers. Prove that the mapping $f: \mathbf{C} \rightarrow \mathbf{R}$ given by $f(z) = |z|, \forall z \in \mathbf{C}$, is neither one-one nor onto.
11. Let the function $f: \mathbf{R} \rightarrow \mathbf{R}$ be defined by $f(x) = \cos x, \forall x \in \mathbf{R}$. Show that f is neither one-one nor onto.
12. Let $X = \{1, 2, 3\}$ and $Y = \{4, 5\}$. Find whether the following subsets of $X \times Y$ are functions from X to Y or not.
- (i) $f = \{(1, 4), (1, 5), (2, 4), (3, 5)\}$ (ii) $g = \{(1, 4), (2, 4), (3, 4)\}$
- (iii) $h = \{(1, 4), (2, 5), (3, 5)\}$ (iv) $k = \{(1, 4), (2, 5)\}$.
13. If functions $f: A \rightarrow B$ and $g: B \rightarrow A$ satisfy $g \circ f = I_A$, then show that f is one-one and g is onto.

14. Let $f: \mathbf{R} \rightarrow \mathbf{R}$ be the function defined by $f(x) = \frac{1}{2 - \cos x}$, $x \in \mathbf{R}$. Then, find the range of f .
15. Let n be a fixed positive integer. Define a relation R in \mathbf{Z} as follows: $a, b \in \mathbf{Z}$, aRb if and only if $a - b$ is divisible by n . Show that R is an equivalence relation.

Long Answer (L.A.)

16. If $A = \{1, 2, 3, 4\}$, define relations on A which have properties of being:
- reflexive, transitive but not symmetric
 - symmetric but neither reflexive nor transitive
 - reflexive, symmetric and transitive.
17. Let R be relation defined on the set of natural number \mathbf{N} as follows:
 $R = \{(x, y): x \in \mathbf{N}, y \in \mathbf{N}, 2x + y = 41\}$. Find the domain and range of the relation R . Also verify whether R is reflexive, symmetric and transitive.
18. Given $A = \{2, 3, 4\}$, $B = \{2, 5, 6, 7\}$. Construct an example of each of the following:
- an injective mapping from A to B
 - a mapping from A to B which is not injective
 - a mapping from B to A .
19. Give an example of a map
- which is one-one but not onto
 - which is not one-one but onto
 - which is neither one-one nor onto.
20. Let $A = \mathbf{R} - \{3\}$, $B = \mathbf{R} - \{1\}$. Let $f: A \rightarrow B$ be defined by $f(x) = \frac{x-2}{x-3}$, $x \in A$. Then show that f is bijective.
21. Let $A = [-1, 1]$. Then, discuss whether the following functions defined on A are one-one, onto or bijective:
- $f(x) = \frac{x}{2}$
 - $g(x) = |x|$
 - $h(x) = x|x|$
 - $k(x) = x^2$
22. Each of the following defines a relation on \mathbf{N} :
- x is greater than y , $x, y \in \mathbf{N}$
 - $x + y = 10$, $x, y \in \mathbf{N}$

(iii) x, y is square of an integer $x, y \in \mathbf{N}$

(iv) $x + 4y = 10$ $x, y \in \mathbf{N}$.

Determine which of the above relations are reflexive, symmetric and transitive.

- 23.** Let $A = \{1, 2, 3, \dots, 9\}$ and R be the relation in $A \times A$ defined by $(a, b) R (c, d)$ if $a + d = b + c$ for $(a, b), (c, d)$ in $A \times A$. Prove that R is an equivalence relation and also obtain the equivalent class $[(2, 5)]$.
- 24.** Using the definition, prove that the function $f: A \rightarrow B$ is invertible if and only if f is both one-one and onto.
- 25.** Functions $f, g: \mathbf{R} \rightarrow \mathbf{R}$ are defined, respectively, by $f(x) = x^2 + 3x + 1$, $g(x) = 2x - 3$, find
- (i) $f \circ g$ (ii) $g \circ f$ (iii) $f \circ f$ (iv) $g \circ g$
- 26.** Let $*$ be the binary operation defined on \mathbf{Q} . Find which of the following binary operations are commutative
- (i) $a * b = a - b$ $a, b \in \mathbf{Q}$ (ii) $a * b = a^2 + b^2$ $a, b \in \mathbf{Q}$
 (iii) $a * b = a + ab$ $a, b \in \mathbf{Q}$ (iv) $a * b = (a - b)^2$ $a, b \in \mathbf{Q}$
- 27.** Let $*$ be binary operation defined on \mathbf{R} by $a * b = 1 + ab$, $a, b \in \mathbf{R}$. Then the operation $*$ is
- (i) commutative but not associative
 (ii) associative but not commutative
 (iii) neither commutative nor associative
 (iv) both commutative and associative

Objective Type Questions

Choose the correct answer out of the given four options in each of the Exercises from 28 to 47 (M.C.Q.).

- 28.** Let T be the set of all triangles in the Euclidean plane, and let a relation R on T be defined as aRb if a is congruent to b $a, b \in T$. Then R is
- (A) reflexive but not transitive (B) transitive but not symmetric
 (C) equivalence (D) none of these
- 29.** Consider the non-empty set consisting of children in a family and a relation R defined as aRb if a is brother of b . Then R is
- (A) symmetric but not transitive (B) transitive but not symmetric
 (C) neither symmetric nor transitive (D) both symmetric and transitive

- 30.** The maximum number of equivalence relations on the set $A = \{1, 2, 3\}$ are
 (A) 1 (B) 2
 (C) 3 (D) 5
- 31.** If a relation R on the set $\{1, 2, 3\}$ be defined by $R = \{(1, 2)\}$, then R is
 (A) reflexive (B) transitive
 (C) symmetric (D) none of these
- 32.** Let us define a relation R in \mathbf{R} as aRb if $a \geq b$. Then R is
 (A) an equivalence relation (B) reflexive, transitive but not symmetric
 (C) symmetric, transitive but not reflexive (D) neither transitive nor reflexive but symmetric.
- 33.** Let $A = \{1, 2, 3\}$ and consider the relation
 $R = \{(1, 1), (2, 2), (3, 3), (1, 2), (2, 3), (1, 3)\}$.
 Then R is
 (A) reflexive but not symmetric (B) reflexive but not transitive
 (C) symmetric and transitive (D) neither symmetric, nor transitive
- 34.** The identity element for the binary operation $*$ defined on $Q \sim \{0\}$ as
 $a * b = \frac{ab}{2}$, $a, b \in Q \sim \{0\}$ is
 (A) 1 (B) 0
 (C) 2 (D) none of these
- 35.** If the set A contains 5 elements and the set B contains 6 elements, then the number of one-one and onto mappings from A to B is
 (A) 720 (B) 120
 (C) 0 (D) none of these
- 36.** Let $A = \{1, 2, 3, \dots, n\}$ and $B = \{a, b\}$. Then the number of surjections from A into B is
 (A) ${}^n P_2$ (B) $2^n - 2$
 (C) $2^n - 1$ (D) None of these

37. Let $f: \mathbf{R} \rightarrow \mathbf{R}$ be defined by $f(x) = \frac{1}{x}$, $x \in \mathbf{R}$. Then f is
- (A) one-one (B) onto
(C) bijective (D) f is not defined
38. Let $f: \mathbf{R} \rightarrow \mathbf{R}$ be defined by $f(x) = 3x^2 - 5$ and $g: \mathbf{R} \rightarrow \mathbf{R}$ by $g(x) = \frac{x}{x^2+1}$.
Then $g \circ f$ is
- (A) $\frac{3x^2 - 5}{9x^4 - 30x^2 + 26}$ (B) $\frac{3x^2 - 5}{9x^4 - 6x^2 + 26}$
(C) $\frac{3x^2}{x^4 + 2x^2 - 4}$ (D) $\frac{3x^2}{9x^4 + 30x^2 - 2}$
39. Which of the following functions from \mathbf{Z} into \mathbf{Z} are bijections?
- (A) $f(x) = x^3$ (B) $f(x) = x + 2$
(C) $f(x) = 2x + 1$ (D) $f(x) = x^2 + 1$
40. Let $f: \mathbf{R} \rightarrow \mathbf{R}$ be the functions defined by $f(x) = x^3 + 5$. Then $f^{-1}(x)$ is
- (A) $(x+5)^{\frac{1}{3}}$ (B) $(x-5)^{\frac{1}{3}}$
(C) $(5-x)^{\frac{1}{3}}$ (D) $5 - x$
41. Let $f: A \rightarrow B$ and $g: B \rightarrow C$ be the bijective functions. Then $(g \circ f)^{-1}$ is
- (A) $f^{-1} \circ g^{-1}$ (B) $f \circ g$
(C) $g^{-1} \circ f^{-1}$ (D) $g \circ f$
42. Let $f: \mathbf{R} - \left\{ \frac{3}{5} \right\} \rightarrow \mathbf{R}$ be defined by $f(x) = \frac{3x+2}{5x-3}$. Then
- (A) $f^{-1}(x) = f(x)$ (B) $f^{-1}(x) = -f(x)$
(C) $(f \circ f)x = -x$ (D) $f^{-1}(x) = \frac{1}{19}f(x)$
43. Let $f: [0, 1] \rightarrow [0, 1]$ be defined by $f(x) = \begin{cases} x, & \text{if } x \text{ is rational} \\ 1-x, & \text{if } x \text{ is irrational} \end{cases}$

Then $(f \circ f) x$ is

- (A) constant (B) $1 + x$
 (C) x (D) none of these

44. Let $f : [2, \infty) \rightarrow \mathbf{R}$ be the function defined by $f(x) = x^2 - 4x + 5$, then the range of f is

- (A) \mathbf{R} (B) $[1, \infty)$
 (C) $[4, \infty)$ (D) $[5, \infty)$

45. Let $f : \mathbf{N} \rightarrow \mathbf{R}$ be the function defined by $f(x) = \frac{2x-1}{2}$ and $g : \mathbf{Q} \rightarrow \mathbf{R}$ be

another function defined by $g(x) = x + 2$. Then $(g \circ f) \frac{3}{2}$ is

- (A) 1 (B) 1
 (C) $\frac{7}{2}$ (D) none of these

46. Let $f : \mathbf{R} \rightarrow \mathbf{R}$ be defined by

$$f(x) = \begin{cases} 2x : x > 3 \\ x^2 : 1 < x \leq 3 \\ 3x : x \leq 1 \end{cases}$$

Then $f(-1) + f(2) + f(4)$ is

- (A) 9 (B) 14
 (C) 5 (D) none of these

47. Let $f : \mathbf{R} \rightarrow \mathbf{R}$ be given by $f(x) = \tan x$. Then $f^{-1}(1)$ is

- (A) $\frac{\pi}{4}$ (B) $\{n\pi + \frac{\pi}{4} : n \in \mathbf{Z}\}$
 (C) does not exist (D) none of these

Fill in the blanks in each of the Exercises 48 to 52.

48. Let the relation R be defined in \mathbf{N} by aRb if $2a + 3b = 30$. Then $R = \underline{\hspace{2cm}}$.

49. Let the relation R be defined on the set

$A = \{1, 2, 3, 4, 5\}$ by $R = \{(a, b) : |a^2 - b^2| < 8\}$. Then R is given by $\underline{\hspace{2cm}}$.

50. Let $f = \{(1, 2), (3, 5), (4, 1)\}$ and $g = \{(2, 3), (5, 1), (1, 3)\}$. Then $g \circ f = \underline{\hspace{2cm}}$ and $f \circ g = \underline{\hspace{2cm}}$.

- 51.** Let $f: \mathbf{R} \rightarrow \mathbf{R}$ be defined by $f(x) = \frac{x}{\sqrt{1+x^2}}$. Then $(f \circ f \circ f)(x) = \text{—————}$
- 52.** If $f(x) = (4 - (x-7)^3)$, then $f^{-1}(x) = \text{—————}$.

State **True** or **False** for the statements in each of the Exercises 53 to 63.

- 53.** Let $R = \{(3, 1), (1, 3), (3, 3)\}$ be a relation defined on the set $A = \{1, 2, 3\}$. Then R is symmetric, transitive but not reflexive.
- 54.** Let $f: \mathbf{R} \rightarrow \mathbf{R}$ be the function defined by $f(x) = \sin(3x+2)$ $x \in \mathbf{R}$. Then f is invertible.
- 55.** Every relation which is symmetric and transitive is also reflexive.
- 56.** An integer m is said to be related to another integer n if m is an integral multiple of n . This relation in \mathbf{Z} is reflexive, symmetric and transitive.
- 57.** Let $A = \{0, 1\}$ and \mathbf{N} be the set of natural numbers. Then the mapping $f: \mathbf{N} \rightarrow A$ defined by $f(2n-1) = 0, f(2n) = 1, n \in \mathbf{N}$, is onto.
- 58.** The relation R on the set $A = \{1, 2, 3\}$ defined as $R = \{(1, 1), (1, 2), (2, 1), (3, 3)\}$ is reflexive, symmetric and transitive.
- 59.** The composition of functions is commutative.
- 60.** The composition of functions is associative.
- 61.** Every function is invertible.
- 62.** A binary operation on a set has always the identity element.



INVERSE TRIGONOMETRIC FUNCTIONS

2.1 Overview

2.1.1 Inverse function

Inverse of a function ' f ' exists, if the function is one-one and onto, i.e, bijective. Since trigonometric functions are many-one over their domains, we restrict their domains and co-domains in order to make them one-one and onto and then find their inverse. The domains and ranges (principal value branches) of inverse trigonometric functions are given below:

Functions	Domain	Range (Principal value branches)
$y = \sin^{-1}x$	$[-1,1]$	$\frac{-\pi}{2}, \frac{\pi}{2}$
$y = \cos^{-1}x$	$[-1,1]$	$[0,\pi]$
$y = \operatorname{cosec}^{-1}x$	$\mathbf{R} - (-1,1)$	$\frac{-\pi}{2}, \frac{\pi}{2} - \{0\}$
$y = \sec^{-1}x$	$\mathbf{R} - (-1,1)$	$[0,\pi] - \frac{\pi}{2}$
$y = \tan^{-1}x$	\mathbf{R}	$\frac{-\pi}{2}, \frac{\pi}{2}$
$y = \cot^{-1}x$	\mathbf{R}	$(0,\pi)$

Notes:

- (i) The symbol $\sin^{-1}x$ should not be confused with $(\sin x)^{-1}$. Infact $\sin^{-1}x$ is an angle, the value of whose sine is x , similarly for other trigonometric functions.
- (ii) The smallest numerical value, either positive or negative, of θ is called the principal value of the function.

- (iii) Whenever no branch of an inverse trigonometric function is mentioned, we mean the principal value branch. The value of the inverse trigonometric function which lies in the range of principal branch is its principal value.

2.1.2 Graph of an inverse trigonometric function

The graph of an inverse trigonometric function can be obtained from the graph of original function by interchanging x -axis and y -axis, i.e. if (a, b) is a point on the graph of trigonometric function, then (b, a) becomes the corresponding point on the graph of its inverse trigonometric function.

It can be shown that the graph of an inverse function can be obtained from the corresponding graph of original function as a mirror image (i.e., reflection) along the line $y = x$.

2.1.3 Properties of inverse trigonometric functions

1. $\sin^{-1}(\sin x) = x$: $x \in \left(-\frac{\pi}{2}, \frac{\pi}{2}\right]$
- $\cos^{-1}(\cos x) = x$: $x \in [0, \pi]$
- $\tan^{-1}(\tan x) = x$: $x \in \left(-\frac{\pi}{2}, \frac{\pi}{2}\right)$
- $\cot^{-1}(\cot x) = x$: $x \in (0, \pi)$
- $\sec^{-1}(\sec x) = x$: $x \in [0, \pi] - \frac{\pi}{2}$
- $\operatorname{cosec}^{-1}(\operatorname{cosec} x) = x$: $x \in \left(-\frac{\pi}{2}, \frac{\pi}{2}\right) - \{0\}$
2. $\sin(\sin^{-1} x) = x$: $x \in [-1, 1]$
- $\cos(\cos^{-1} x) = x$: $x \in [-1, 1]$
- $\tan(\tan^{-1} x) = x$: $x \in \mathbf{R}$
- $\cot(\cot^{-1} x) = x$: $x \in \mathbf{R}$
- $\sec(\sec^{-1} x) = x$: $x \in \mathbf{R} - (-1, 1)$
- $\operatorname{cosec}(\operatorname{cosec}^{-1} x) = x$: $x \in \mathbf{R} - (-1, 1)$
3. $\sin^{-1} \frac{1}{x} = \operatorname{cosec}^{-1} x$: $x \in \mathbf{R} - (-1, 1)$
- $\cos^{-1} \frac{1}{x} = \sec^{-1} x$: $x \in \mathbf{R} - (-1, 1)$

- $$\begin{aligned} \tan^{-1} \frac{1}{x} - \cot^{-1} x & : & x > 0 \\ = -\pi + \cot^{-1} x & : & x < 0 \end{aligned}$$
- 4.**
- $$\begin{aligned} \sin^{-1}(-x) &= -\sin^{-1} x & : & x \in [-1, 1] \\ \cos^{-1}(-x) &= \pi - \cos^{-1} x & : & x \in [-1, 1] \\ \tan^{-1}(-x) &= -\tan^{-1} x & : & x \in \mathbf{R} \\ \cot^{-1}(-x) &= \pi - \cot^{-1} x & : & x \in \mathbf{R} \\ \sec^{-1}(-x) &= \pi - \sec^{-1} x & : & x \in \mathbf{R} \text{ } -(-1, 1) \\ \operatorname{cosec}^{-1}(-x) &= -\operatorname{cosec}^{-1} x & : & x \in \mathbf{R} \text{ } -(-1, 1) \end{aligned}$$
- 5.**
- $$\begin{aligned} \sin^{-1} x + \cos^{-1} x &= \frac{\pi}{2} & : & x \in [-1, 1] \\ \tan^{-1} x + \cot^{-1} x &= \frac{\pi}{2} & : & x \in \mathbf{R} \\ \sec^{-1} x + \operatorname{cosec}^{-1} x &= \frac{\pi}{2} & : & x \in \mathbf{R} \text{ } -[-1, 1] \end{aligned}$$
- 6.**
- $$\begin{aligned} \tan^{-1} x + \tan^{-1} y &= \tan^{-1} \frac{x+y}{1-xy} & : & xy < 1 \\ \tan^{-1} x - \tan^{-1} y &= \tan^{-1} \left(\frac{x-y}{1+xy} \right) & : & xy > -1 \end{aligned}$$
- 7.**
- $$\begin{aligned} 2 \tan^{-1} x &= \sin^{-1} \frac{2x}{1-x^2} & : & -1 \leq x \leq 1 \\ 2 \tan^{-1} x &= \cos^{-1} \frac{1-x^2}{1+x^2} & : & x \geq 0 \\ 2 \tan^{-1} x &= \tan^{-1} \frac{2x}{1-x^2} & : & -1 < x < 1 \end{aligned}$$

2.2 Solved Examples

Short Answer (S.A.)

Example 1 Find the principal value of $\cos^{-1} x$, for $x = \frac{\sqrt{3}}{2}$.

Solution If $\cos^{-1} \frac{\sqrt{3}}{2} = \theta$, then $\cos \theta = \frac{\sqrt{3}}{2}$.

Since we are considering principal branch, $\theta \in [0, \pi]$. Also, since $\frac{\sqrt{3}}{2} > 0$, θ being in

the first quadrant, hence $\cos^{-1} \frac{\sqrt{3}}{2} = \frac{\pi}{6}$.

Example 2 Evaluate $\tan^{-1} \sin \frac{-\pi}{2}$.

Solution $\tan^{-1} \sin \frac{-\pi}{2} = \tan^{-1} \left(-\sin \left(\frac{\pi}{2} \right) \right) = \tan^{-1}(-1) = -\frac{\pi}{4}$.

Example 3 Find the value of $\cos^{-1} \cos \frac{13\pi}{6}$.

Solution $\cos^{-1} \cos \frac{13\pi}{6} = \cos^{-1} \left(\cos \left(2\pi + \frac{\pi}{6} \right) \right) = \cos^{-1} \left(\cos \frac{\pi}{6} \right)$
 $= \frac{\pi}{6}$.

Example 4 Find the value of $\tan^{-1} \tan \frac{9\pi}{8}$.

Solution $\tan^{-1} \tan \frac{9\pi}{8} = \tan^{-1} \tan \left(\pi + \frac{\pi}{8} \right)$
 $= \tan^{-1} \left(\tan \left(\frac{\pi}{8} \right) \right) = \frac{\pi}{8}$

Example 5 Evaluate $\tan (\tan^{-1}(-4))$.

Solution Since $\tan (\tan^{-1}x) = x$, $\forall x \in \mathbb{R}$, $\tan (\tan^{-1}(-4)) = -4$.

Example 6 Evaluate: $\tan^{-1} \sqrt{3} - \sec^{-1}(-2)$.

Solution $\tan^{-1}\sqrt{3} - \sec^{-1}(-2) = \tan^{-1}\sqrt{3} - [\pi - \sec^{-1}2]$

$$= \frac{\pi}{3} - \pi + \cos^{-1}\left(\frac{1}{2}\right) = -\frac{2\pi}{3} + \frac{\pi}{3} = -\frac{\pi}{3}.$$

Example 7 Evaluate: $\sin^{-1} \cos \sin^{-1} \frac{\sqrt{3}}{2}$

Solution $\sin^{-1} \cos \sin^{-1} \frac{\sqrt{3}}{2} = \sin^{-1} \cos \frac{\pi}{3} = \sin^{-1} \frac{1}{2} = \frac{\pi}{6}.$

Example 8 Prove that $\tan(\cot^{-1}x) = \cot(\tan^{-1}x)$. State with reason whether the equality is valid for all values of x .

Solution Let $\cot^{-1}x = \theta$. Then $\cot \theta = x$

or, $\tan \frac{\pi}{2} - \theta = x \Rightarrow \tan^{-1}x = \frac{\pi}{2} - \theta$

So $\tan(\cot^{-1}x) = \tan \theta = \cot\left(\frac{\pi}{2} - \theta\right) = \cot\left(\frac{\pi}{2} - \cot^{-1}x\right) = \cot(\tan^{-1}x)$

The equality is valid for all values of x since $\tan^{-1}x$ and $\cot^{-1}x$ are true for $x \in \mathbf{R}$.

Example 9 Find the value of $\sec\left(\tan^{-1}\frac{y}{2}\right)$.

Solution Let $\tan^{-1}\frac{y}{2} = \theta$, where $\theta \in \left(-\frac{\pi}{2}, \frac{\pi}{2}\right)$. So, $\tan \theta = \frac{y}{2}$,

which gives $\sec \theta = \frac{\sqrt{4 + y^2}}{2}$.

Therefore, $\sec\left(\tan^{-1}\frac{y}{2}\right) = \sec \theta = \frac{\sqrt{4 + y^2}}{2}$.

Example 10 Find value of $\tan(\cos^{-1}x)$ and hence evaluate $\tan \cos^{-1} \frac{8}{17}$.

Solution Let $\cos^{-1}x = \theta$, then $\cos \theta = x$, where $\theta \in [0, \pi]$

Therefore, $\tan(\cos^{-1}x) = \tan\theta = \frac{\sqrt{1-\cos^2\theta}}{\cos\theta} = \frac{\sqrt{1-x^2}}{x}$.

Hence $\tan\left(\cos^{-1}\frac{8}{17}\right) = \frac{\sqrt{1-\left(\frac{8}{17}\right)^2}}{\frac{8}{17}} = \frac{15}{8}$.

Example 11 Find the value of $\sin 2\cot^{-1}\frac{-5}{12}$

Solution Let $\cot^{-1}\left(\frac{-5}{12}\right) = y$. Then $\cot y = \frac{-5}{12}$.

Now $\sin 2\cot^{-1}\frac{-5}{12} = \sin 2y$

$$= 2\sin y \cos y = 2 \frac{12}{13} \frac{-5}{13} \left[\text{since } \cot y < 0, \text{ so } y \in \left(\frac{\pi}{2}, \pi\right) \right]$$

$$\frac{-120}{169}$$

Example 12 Evaluate $\cos \sin^{-1}\frac{1}{4} \sec^{-1}\frac{4}{3}$

Solution $\cos \sin^{-1}\frac{1}{4} \sec^{-1}\frac{4}{3} = \cos \left[\sin^{-1}\frac{1}{4} + \cos^{-1}\frac{3}{4} \right]$

$$= \cos \sin^{-1}\frac{1}{4} \cos \cos^{-1}\frac{3}{4} - \sin \sin^{-1}\frac{1}{4} \sin \cos^{-1}\frac{3}{4}$$

$$= \frac{3}{4} \sqrt{1 - \frac{1}{4}^2} - \frac{1}{4} \sqrt{1 - \frac{3}{4}^2}$$

$$= \frac{3\sqrt{15}}{4} - \frac{1\sqrt{7}}{4} = \frac{3\sqrt{15} - \sqrt{7}}{4}$$

Long Answer (L.A.)

Example 13 Prove that $2\sin^{-1}\frac{3}{5} - \tan^{-1}\frac{17}{31} = \frac{\pi}{4}$

Solution Let $\sin^{-1}\frac{3}{5} = \theta$, then $\sin\theta = \frac{3}{5}$, where $\theta \in \left[-\frac{\pi}{2}, \frac{\pi}{2}\right]$

Thus $\tan\theta = \frac{3}{4}$, which gives $\theta = \tan^{-1}\frac{3}{4}$.

$$\begin{aligned} \text{Therefore, } \quad & 2\sin^{-1}\frac{3}{5} - \tan^{-1}\frac{17}{31} \\ &= 2\theta - \tan^{-1}\frac{17}{31} = 2\tan^{-1}\frac{3}{4} - \tan^{-1}\frac{17}{31} \\ &= \tan^{-1}\left(\frac{2\cdot\frac{3}{4}}{1-\frac{9}{16}}\right) - \tan^{-1}\frac{17}{31} = \tan^{-1}\frac{24}{7} - \tan^{-1}\frac{17}{31} \\ &= \tan^{-1}\left(\frac{\frac{24}{7} - \frac{17}{31}}{1 + \frac{24}{7}\cdot\frac{17}{31}}\right) = \frac{\pi}{4} \end{aligned}$$

Example 14 Prove that

$$\cot^{-1}7 + \cot^{-1}8 + \cot^{-1}18 = \cot^{-1}3$$

Solution We have

$$\begin{aligned} & \cot^{-1}7 + \cot^{-1}8 + \cot^{-1}18 \\ &= \tan^{-1}\frac{1}{7} + \tan^{-1}\frac{1}{8} + \tan^{-1}\frac{1}{18} \quad (\text{since } \cot^{-1}x = \tan^{-1}\frac{1}{x}, \text{ if } x > 0) \\ &= \tan^{-1}\left(\frac{\frac{1}{7} + \frac{1}{8}}{1 - \frac{1}{7}\times\frac{1}{8}}\right) + \tan^{-1}\frac{1}{18} \quad (\text{since } x \cdot y = \frac{1}{7}\cdot\frac{1}{8} < 1) \end{aligned}$$

$$\begin{aligned}
 &= \tan^{-1} \frac{3}{11} + \tan^{-1} \frac{1}{18} = \tan^{-1} \left(\frac{\frac{3}{11} + \frac{1}{18}}{1 - \frac{3}{11} \times \frac{1}{18}} \right) \quad (\text{since } xy < 1) \\
 &= \tan^{-1} \frac{65}{195} = \tan^{-1} \frac{1}{3} = \cot^{-1} 3
 \end{aligned}$$

Example 15 Which is greater, $\tan 1$ or $\tan^{-1} 1$?

Solution From Fig. 2.1, we note that $\tan x$ is an increasing function in the interval

$\left(\frac{-\pi}{2}, \frac{\pi}{2}\right)$, since $1 > \frac{\pi}{4} \Rightarrow \tan 1 > \tan \frac{\pi}{4}$. This gives

$$\begin{aligned}
 &\tan 1 > 1 \\
 \Rightarrow &\tan 1 > 1 > \frac{\pi}{4} \\
 \Rightarrow &\tan 1 > 1 > \tan^{-1}(1).
 \end{aligned}$$

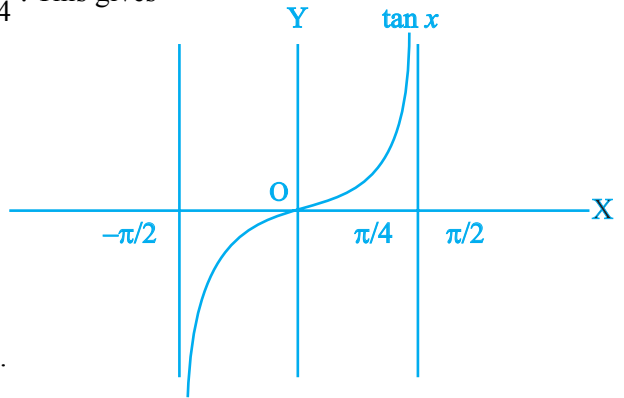

Example 16 Find the value of

$$\sin\left(2 \tan^{-1} \frac{2}{3}\right) + \cos(\tan^{-1} \sqrt{3}).$$

Solution Let $\tan^{-1} \frac{2}{3} = x$ and $\tan^{-1} \sqrt{3} = y$ so that $\tan x = \frac{2}{3}$ and $\tan y = \sqrt{3}$.

$$\begin{aligned}
 \text{Therefore,} \quad &\sin\left(2 \tan^{-1} \frac{2}{3}\right) + \cos(\tan^{-1} \sqrt{3}) \\
 &= \sin(2x) + \cos y \\
 &= \frac{2 \tan x}{1 + \tan^2 x} + \frac{1}{\sqrt{1 + \tan^2 y}} = \frac{2 \cdot \frac{2}{3}}{1 + \frac{4}{9}} + \frac{1}{1 + \sqrt{(\sqrt{3})^2}} \\
 &= \frac{12}{13} + \frac{1}{2} = \frac{37}{26}.
 \end{aligned}$$

Example 17 Solve for x

$$\tan^{-1}\left(\frac{1-x}{1+x}\right) = \frac{1}{2} \tan^{-1} x, \quad x > 0$$

Solution From given equation, we have $2 \tan^{-1}\left(\frac{1-x}{1+x}\right) = \tan^{-1} x$

$$\Rightarrow 2[\tan^{-1} 1 - \tan^{-1} x] = \tan^{-1} x$$

$$\Rightarrow 2\left(\frac{\pi}{4}\right) = 3 \tan^{-1} x \Rightarrow \frac{\pi}{6} = \tan^{-1} x$$

$$\Rightarrow x = \frac{1}{\sqrt{3}}$$

Example 18 Find the values of x which satisfy the equation

$$\sin^{-1} x + \sin^{-1} (1-x) = \cos^{-1} x.$$

Solution From the given equation, we have

$$\sin(\sin^{-1} x + \sin^{-1} (1-x)) = \sin(\cos^{-1} x)$$

$$\Rightarrow \sin(\sin^{-1} x) \cos(\sin^{-1} (1-x)) + \cos(\sin^{-1} x) \sin(\sin^{-1} (1-x)) = \sin(\cos^{-1} x)$$

$$\Rightarrow x \sqrt{1-(1-x)^2} + (1-x) \sqrt{1-x^2} = \sqrt{1-x^2}$$

$$\Rightarrow x \sqrt{2x-x^2} + \sqrt{1-x^2} (1-x-1) = 0$$

$$\Rightarrow x(\sqrt{2x-x^2} - \sqrt{1-x^2}) = 0$$

$$\Rightarrow x = 0 \quad \text{or} \quad 2x - x^2 = 1 - x^2$$

$$\Rightarrow x = 0 \quad \text{or} \quad x = \frac{1}{2}$$

Example 19 Solve the equation $\sin^{-1} 6x + \sin^{-1} 6\sqrt{3}x = -\frac{\pi}{2}$

Solution From the given equation, we have $\sin^{-1} 6x = -\frac{\pi}{2} - \sin^{-1} 6\sqrt{3}x$

$$\Rightarrow \sin(\sin^{-1} 6x) = \sin\left(-\frac{\pi}{2} - \sin^{-1} 6\sqrt{3}x\right)$$

$$\Rightarrow 6x = -\cos(\sin^{-1} 6\sqrt{3}x)$$

$$\Rightarrow 6x = -\sqrt{1-108x^2}. \text{ Squaring, we get}$$

$$36x^2 = 1 - 108x^2$$

$$\Rightarrow 144x^2 = 1 \quad \Rightarrow x = \pm \frac{1}{12}$$

Note that $x = -\frac{1}{12}$ is the only root of the equation as $x = \frac{1}{12}$ does not satisfy it.

Example 20 Show that

$$2 \tan^{-1} \left\{ \tan \frac{\alpha}{2} \cdot \tan \left(\frac{\pi}{4} - \frac{\beta}{2} \right) \right\} = \tan^{-1} \frac{\sin \alpha \cos \beta}{\cos \alpha + \sin \beta}$$

Solution L.H.S. = $\tan^{-1} \frac{2 \tan \frac{\alpha}{2} \cdot \tan \left(\frac{\pi}{4} - \frac{\beta}{2} \right)}{1 - \tan^2 \frac{\alpha}{2} \tan^2 \left(\frac{\pi}{4} - \frac{\beta}{2} \right)}$ (since $2 \tan^{-1} x = \tan^{-1} \frac{2x}{1-x^2}$)

$$= \tan^{-1} \frac{2 \tan \frac{\alpha}{2} \frac{1 - \tan \frac{\beta}{2}}{1 + \tan \frac{\beta}{2}}}{1 - \tan^2 \frac{\alpha}{2} \left(\frac{1 - \tan \frac{\beta}{2}}{1 + \tan \frac{\beta}{2}} \right)^2}$$

$$= \tan^{-1} \frac{2 \tan \frac{\alpha}{2} \cdot \left(1 - \tan^2 \frac{\beta}{2} \right)}{\left(1 + \tan \frac{\beta}{2} \right)^2 - \tan^2 \frac{\alpha}{2} \left(1 - \tan \frac{\beta}{2} \right)^2}$$

$$\begin{aligned}
&= \tan^{-1} \frac{2 \tan \frac{\alpha}{2} \left(1 - \tan^2 \frac{\beta}{2}\right)}{\left(1 + \tan^2 \frac{\beta}{2}\right) \left(1 - \tan^2 \frac{\alpha}{2}\right) + 2 \tan \frac{\beta}{2} \left(1 + \tan^2 \frac{\alpha}{2}\right)} \\
&= \tan^{-1} \frac{\frac{2 \tan \frac{\alpha}{2}}{1 + \tan^2 \frac{\alpha}{2}} \frac{1 - \tan^2 \frac{\beta}{2}}{1 + \tan^2 \frac{\beta}{2}}}{\frac{1 - \tan^2 \frac{\alpha}{2}}{1 + \tan^2 \frac{\alpha}{2}} + \frac{2 \tan \frac{\beta}{2}}{1 + \tan^2 \frac{\beta}{2}}} \\
&= \tan^{-1} \left(\frac{\sin \alpha \cos \beta}{\cos \alpha + \sin \beta} \right) = \text{R.H.S.}
\end{aligned}$$

Objective type questions

Choose the correct answer from the given four options in each of the Examples 21 to 41.

Example 21 Which of the following corresponds to the principal value branch of \tan^{-1} ?

- (A) $\left(-\frac{\pi}{2}, \frac{\pi}{2}\right)$ (B) $\left[-\frac{\pi}{2}, \frac{\pi}{2}\right]$
 (C) $\left(-\frac{\pi}{2}, \frac{\pi}{2}\right) - \{0\}$ (D) $(0, \pi)$

Solution (A) is the correct answer.

Example 22 The principal value branch of \sec^{-1} is

- (A) $\left[-\frac{\pi}{2}, \frac{\pi}{2}\right] - \{0\}$ (B) $[0, \pi] - \left\{\frac{\pi}{2}\right\}$
 (C) $(0, \pi)$ (D) $\left(-\frac{\pi}{2}, \frac{\pi}{2}\right)$

Solution (B) is the correct answer.

Example 23 One branch of \cos^{-1} other than the principal value branch corresponds to

- (A) $\left[\frac{\pi}{2}, \frac{3\pi}{2}\right]$ (B) $[\pi, 2\pi] - \left\{\frac{3\pi}{2}\right\}$
 (C) $(0, \pi)$ (D) $[2\pi, 3\pi]$

Solution (D) is the correct answer.

Example 24 The value of $\sin^{-1}\left(\cos\left(\frac{43\pi}{5}\right)\right)$ is

- (A) $\frac{3\pi}{5}$ (B) $\frac{-7\pi}{5}$ (C) $\frac{\pi}{10}$ (D) $-\frac{\pi}{10}$

Solution (D) is the correct answer. $\sin^{-1}\left(\cos\frac{40\pi+3\pi}{5}\right) = \sin^{-1}\cos\left(8\pi+\frac{3\pi}{5}\right)$

$$= \sin^{-1}\left(\cos\frac{3\pi}{5}\right) = \sin^{-1}\left(\sin\left(\frac{\pi}{2}-\frac{3\pi}{5}\right)\right)$$

$$= \sin^{-1}\left(\sin\left(-\frac{\pi}{10}\right)\right) = -\frac{\pi}{10}.$$

Example 25 The principal value of the expression $\cos^{-1}[\cos(-680^\circ)]$ is

- (A) $\frac{2\pi}{9}$ (B) $\frac{-2\pi}{9}$ (C) $\frac{34\pi}{9}$ (D) $\frac{\pi}{9}$

Solution (A) is the correct answer. $\cos^{-1}(\cos(680^\circ)) = \cos^{-1}[\cos(720^\circ - 40^\circ)]$

$$= \cos^{-1}[\cos(-40^\circ)] = \cos^{-1}[\cos(40^\circ)] = 40^\circ = \frac{2\pi}{9}.$$

Example 26 The value of $\cot(\sin^{-1}x)$ is

- (A) $\frac{\sqrt{1+x^2}}{x}$ (B) $\frac{x}{\sqrt{1+x^2}}$

(C) $\frac{1}{x}$

(D) $\frac{\sqrt{1-x^2}}{x}$.

Solution (D) is the correct answer. Let $\sin^{-1} x = \theta$, then $\sin \theta = x$

$$\Rightarrow \operatorname{cosec} \theta = \frac{1}{x} \Rightarrow \operatorname{cosec}^2 \theta = \frac{1}{x^2}$$

$$\Rightarrow 1 + \cot^2 \theta = \frac{1}{x^2} \Rightarrow \cot \theta = \frac{\sqrt{1-x^2}}{x}.$$

Example 27 If $\tan^{-1} x = \frac{\pi}{10}$ for some $x \in \mathbf{R}$, then the value of $\cot^{-1} x$ is

(A) $\frac{\pi}{5}$

(B) $\frac{2\pi}{5}$

(C) $\frac{3\pi}{5}$

(D) $\frac{4\pi}{5}$

Solution (B) is the correct answer. We know $\tan^{-1} x + \cot^{-1} x = \frac{\pi}{2}$. Therefore

$$\cot^{-1} x = \frac{\pi}{2} - \frac{\pi}{10}$$

$$\Rightarrow \cot^{-1} x = \frac{\pi}{2} - \frac{\pi}{10} = \frac{2\pi}{5}.$$

Example 28 The domain of $\sin^{-1} 2x$ is

(A) $[0, 1]$

(B) $[-1, 1]$

(C) $\left[-\frac{1}{2}, \frac{1}{2}\right]$

(D) $[-2, 2]$

Solution (C) is the correct answer. Let $\sin^{-1} 2x = \theta$ so that $2x = \sin \theta$.

Now $-1 \leq \sin \theta \leq 1$, i.e., $-1 \leq 2x \leq 1$ which gives $-\frac{1}{2} \leq x \leq \frac{1}{2}$.

Example 29 The principal value of $\sin^{-1} \left(\frac{-\sqrt{3}}{2} \right)$ is

$$(A) \quad -\frac{2\pi}{3} \qquad (B) \quad -\frac{\pi}{3} \qquad (C) \quad \frac{4\pi}{3} \qquad (D) \quad \frac{5\pi}{3}$$

Solution (B) is the correct answer.

$$\sin^{-1}\left(\frac{-\sqrt{3}}{2}\right) = \sin^{-1}\left(-\sin\frac{\pi}{3}\right) = -\sin^{-1}\left(\sin\frac{\pi}{3}\right) = -\frac{\pi}{3}.$$

Example 30 The greatest and least values of $(\sin^{-1}x)^2 + (\cos^{-1}x)^2$ are respectively

$$(A) \quad \frac{5\pi^2}{4} \text{ and } \frac{\pi^2}{8} \qquad (B) \quad \frac{\pi}{2} \text{ and } \frac{-\pi}{2}$$

$$(C) \quad \frac{\pi^2}{4} \text{ and } \frac{-\pi^2}{4} \qquad (D) \quad \frac{\pi^2}{4} \text{ and } 0.$$

Solution (A) is the correct answer. We have

$$\begin{aligned} (\sin^{-1}x)^2 + (\cos^{-1}x)^2 &= (\sin^{-1}x + \cos^{-1}x)^2 - 2 \sin^{-1}x \cos^{-1}x \\ &= \frac{\pi^2}{4} - 2 \sin^{-1}x \left(\frac{\pi}{2} - \sin^{-1}x\right) \\ &= \frac{\pi^2}{4} - \pi \sin^{-1}x + 2(\sin^{-1}x)^2 \\ &= 2 \left[(\sin^{-1}x)^2 - \frac{\pi}{2} \sin^{-1}x + \frac{\pi^2}{8} \right] \\ &= 2 \left[\left(\sin^{-1}x - \frac{\pi}{4} \right)^2 + \frac{\pi^2}{16} \right]. \end{aligned}$$

Thus, the least value is $2 \left(\frac{\pi^2}{16} \right)$ i.e. $\frac{\pi^2}{8}$ and the Greatest value is $2 \left[\left(\frac{-\pi}{2} - \frac{\pi}{4} \right)^2 + \frac{\pi^2}{16} \right]$,

i.e. $\frac{5\pi^2}{4}$.

Example 31 Let $\theta = \sin^{-1}(\sin(-600^\circ))$, then value of θ is

- (A) $\frac{\pi}{3}$ (B) $\frac{\pi}{2}$ (C) $\frac{2\pi}{3}$ (D) $\frac{-2\pi}{3}$.

Solution (A) is the correct answer.

$$\begin{aligned} \sin^{-1} \sin \left(-600 \times \frac{\pi}{180} \right) &= \sin^{-1} \sin \left(\frac{-10\pi}{3} \right) \\ &= \sin^{-1} \left[-\sin \left(4\pi - \frac{2\pi}{3} \right) \right] = \sin^{-1} \left(\sin \frac{2\pi}{3} \right) \\ &= \sin^{-1} \left(\sin \left(\pi - \frac{\pi}{3} \right) \right) = \sin^{-1} \left(\sin \frac{\pi}{3} \right) = \frac{\pi}{3}. \end{aligned}$$

Example 32 The domain of the function $y = \sin^{-1}(-x^2)$ is

- (A) $[0, 1]$ (B) $(0, 1)$
 (C) $[-1, 1]$ (D) ϕ

Solution (C) is the correct answer. $y = \sin^{-1}(-x^2) \Rightarrow \sin y = -x^2$

$$\text{i.e. } -1 \leq -x^2 \leq 1 \quad (\text{since } -1 \leq \sin y \leq 1)$$

$$\Rightarrow 1 \geq x^2 \geq -1$$

$$\Rightarrow 0 \leq x^2 \leq 1$$

$$\Rightarrow |x| \leq 1 \text{ i.e. } -1 \leq x \leq 1$$

Example 33 The domain of $y = \cos^{-1}(x^2 - 4)$ is

- (A) $[3, 5]$ (B) $[0, \pi]$
 (C) $[-\sqrt{5}, -\sqrt{3}] \cap [-\sqrt{5}, \sqrt{3}]$ (D) $[-\sqrt{5}, -\sqrt{3}] \cup [\sqrt{3}, \sqrt{5}]$

Solution (D) is the correct answer. $y = \cos^{-1}(x^2 - 4) \Rightarrow \cos y = x^2 - 4$

$$\text{i.e. } -1 \leq x^2 - 4 \leq 1 \quad (\text{since } -1 \leq \cos y \leq 1)$$

$$\Rightarrow 3 \leq x^2 \leq 5$$

$$\Rightarrow \sqrt{3} \leq |x| \leq \sqrt{5}$$

$$\Rightarrow x \in [-\sqrt{5}, -\sqrt{3}] \cup [\sqrt{3}, \sqrt{5}]$$

Example 34 The domain of the function defined by $f(x) = \sin^{-1}x + \cos x$ is

- (A) $[-1, 1]$ (B) $[-1, \pi + 1]$
 (C) $(-\infty, \infty)$ (D) ϕ

Solution (A) is the correct answer. The domain of \cos is \mathbf{R} and the domain of \sin^{-1} is $[-1, 1]$. Therefore, the domain of $\cos x + \sin^{-1}x$ is $\mathbf{R} \cap [-1, 1]$, i.e., $[-1, 1]$.

Example 35 The value of $\sin(2 \sin^{-1}(-.6))$ is

- (A) $-.48$ (B) $-.96$ (C) 1.2 (D) $\sin 1.2$

Solution (B) is the correct answer. Let $\sin^{-1}(-.6) = \theta$, i.e., $\sin \theta = -.6$.

Now $\sin(2\theta) = 2 \sin\theta \cos\theta = 2(-.6)(.8) = -.96$.

Example 36 If $\sin^{-1}x + \sin^{-1}y = \frac{\pi}{2}$, then value of $\cos^{-1}x + \cos^{-1}y$ is

- (A) $\frac{\pi}{2}$ (B) π (C) 0 (D) $\frac{2\pi}{3}$

Solution (A) is the correct answer. Given that $\sin^{-1}x + \sin^{-1}y = \frac{\pi}{2}$.

Therefore, $\left(\frac{\pi}{2} - \cos^{-1}x\right) + \left(\frac{\pi}{2} - \cos^{-1}y\right) = \frac{\pi}{2}$

$$\Rightarrow \cos^{-1}x + \cos^{-1}y = \frac{\pi}{2}$$

Example 37 The value of $\tan\left(\cos^{-1}\frac{3}{5} + \tan^{-1}\frac{1}{4}\right)$ is

- (A) $\frac{19}{8}$ (B) $\frac{8}{19}$ (C) $\frac{19}{12}$ (D) $\frac{3}{4}$

Solution (A) is the correct answer. $\tan\left(\cos^{-1}\frac{3}{5} + \tan^{-1}\frac{1}{4}\right) = \tan\left(\tan^{-1}\frac{4}{3} + \tan^{-1}\frac{1}{4}\right)$

$$= \tan \tan^{-1} \left(\frac{\frac{4}{3} + \frac{1}{4}}{1 - \frac{4}{3} \times \frac{1}{4}} \right) = \tan \tan^{-1} \left(\frac{19}{8} \right) = \frac{19}{8}.$$

Example 38 The value of the expression $\sin [\cot^{-1} (\cos (\tan^{-1} 1))]$ is

- (A) 0 (B) 1 (C) $\frac{1}{\sqrt{3}}$ (D) $\sqrt{\frac{2}{3}}$.

Solution (D) is the correct answer.

$$\sin [\cot^{-1} (\cos \frac{\pi}{4})] = \sin [\cot^{-1} \frac{1}{\sqrt{2}}] = \sin \left[\sin^{-1} \sqrt{\frac{2}{3}} \right] = \sqrt{\frac{2}{3}}$$

Example 39 The equation $\tan^{-1}x - \cot^{-1}x = \tan^{-1} \left(\frac{1}{\sqrt{3}} \right)$ has

- (A) no solution (B) unique solution
(C) infinite number of solutions (D) two solutions

Solution (B) is the correct answer. We have

$$\tan^{-1}x - \cot^{-1}x = \frac{\pi}{6} \quad \text{and} \quad \tan^{-1}x + \cot^{-1}x = \frac{\pi}{2}$$

Adding them, we get $2\tan^{-1}x = \frac{2\pi}{3}$

$$\Rightarrow \tan^{-1}x = \frac{\pi}{3} \quad \text{i.e.,} \quad x = \sqrt{3}.$$

Example 40 If $\alpha \leq 2 \sin^{-1}x + \cos^{-1}x \leq \beta$, then

- (A) $\alpha = \frac{-\pi}{2}, \beta = \frac{\pi}{2}$ (B) $\alpha = 0, \beta = \pi$
(C) $\alpha = \frac{-\pi}{2}, \beta = \frac{3\pi}{2}$ (D) $\alpha = 0, \beta = 2\pi$

Solution (B) is the correct answer. We have $\frac{-\pi}{2} \leq \sin^{-1} x \leq \frac{\pi}{2}$

$$\Rightarrow \frac{-\pi}{2} + \frac{\pi}{2} \leq \sin^{-1} x + \frac{\pi}{2} \leq \frac{\pi}{2} + \frac{\pi}{2}$$

$$\Rightarrow 0 \leq \sin^{-1} x + (\sin^{-1} x + \cos^{-1} x) \leq \pi$$

$$\Rightarrow 0 \leq 2\sin^{-1} x + \cos^{-1} x \leq \pi$$

Example 41 The value of $\tan^2 (\sec^{-1} 2) + \cot^2 (\operatorname{cosec}^{-1} 3)$ is

- (A) 5 (B) 11 (C) 13 (D) 15

Solution (B) is the correct answer.

$$\tan^2 (\sec^{-1} 2) + \cot^2 (\operatorname{cosec}^{-1} 3) = \sec^2 (\sec^{-1} 2) - 1 + \operatorname{cosec}^2 (\operatorname{cosec}^{-1} 3) - 1$$

$$= 2^2 \times 1 + 3^2 - 2 = 11.$$

2.3 EXERCISE

Short Answer (S.A.)

1. Find the value of $\tan^{-1} \left(\tan \frac{5\pi}{6} \right) + \cos^{-1} \left(\cos \frac{13\pi}{6} \right)$.

2. Evaluate $\cos \cos^{-1} \frac{-\sqrt{3}}{2} - \frac{\pi}{6}$.

3. Prove that $\cot^{-1} \frac{1}{4} - 2 \cot^{-1} 3 = \frac{\pi}{7}$.

4. Find the value of $\tan^{-1} \frac{1}{\sqrt{3}} + \cot^{-1} \frac{1}{\sqrt{3}} - \tan^{-1} \sin \frac{\pi}{2}$.

5. Find the value of $\tan^{-1} \left(\tan \frac{2\pi}{3} \right)$.

6. Show that $2 \tan^{-1} (-3) = \frac{\pi}{2} + \tan^{-1} \left(\frac{-4}{3} \right)$.

7. Find the real solutions of the equation

$$\tan^{-1} \sqrt{x(x+1)} + \sin^{-1} \sqrt{x^2 + x + 1} = \frac{\pi}{2}.$$

8. Find the value of the expression $\sin \left(2 \tan^{-1} \frac{1}{3} \right) + \cos \left(\tan^{-1} 2\sqrt{2} \right)$.

9. If $2 \tan^{-1} (\cos \theta) = \tan^{-1} (2 \operatorname{cosec} \theta)$, then show that $\theta = \frac{\pi}{4}$,
where n is any integer.

10. Show that $\cos \left(2 \tan^{-1} \frac{1}{7} \right) = \sin \left(4 \tan^{-1} \frac{1}{3} \right)$.

11. Solve the following equation $\cos \left(\tan^{-1} x \right) = \sin \left(\cot^{-1} \frac{3}{4} \right)$.

Long Answer (L.A.)

12. Prove that $\tan^{-1} \frac{\sqrt{1-x^2} \sqrt{1-x^2}}{\sqrt{1-x^2} - \sqrt{1-x^2}} = \frac{1}{4} \cos^{-1} x^2$

13. Find the simplified form of $\cos^{-1} \frac{3}{5} \cos x + \frac{4}{5} \sin x$, where $x \in \left[\frac{-3}{4}, \frac{3}{4} \right]$.

14. Prove that $\sin^{-1} \frac{8}{17} + \sin^{-1} \frac{3}{5} = \sin^{-1} \frac{77}{85}$.

15. Show that $\sin^{-1} \frac{5}{13} + \cos^{-1} \frac{3}{5} = \tan^{-1} \frac{63}{16}$.

16. Prove that $\tan^{-1} \frac{1}{4} + \tan^{-1} \frac{2}{9} = \sin^{-1} \frac{1}{\sqrt{5}}$.

17. Find the value of $4 \tan^{-1} \frac{1}{5} - \tan^{-1} \frac{1}{239}$.

18. Show that $\tan^{-1} \frac{3}{4} + \tan^{-1} \frac{4-\sqrt{7}}{3} = \tan^{-1} \frac{4+\sqrt{7}}{3}$ and justify why the other value $\tan^{-1} \frac{4+\sqrt{7}}{3}$ is ignored?
19. If $a_1, a_2, a_3, \dots, a_n$ is an arithmetic progression with common difference d , then evaluate the following expression.

$$\tan \left[\tan^{-1} \left(\frac{d}{1+a_1 a_2} \right) + \tan^{-1} \left(\frac{d}{1+a_2 a_3} \right) + \tan^{-1} \left(\frac{d}{1+a_3 a_4} \right) + \dots + \tan^{-1} \left(\frac{d}{1+a_{n-1} a_n} \right) \right]$$

Objective Type Questions

Choose the correct answers from the given four options in each of the Exercises from 20 to 37 (M.C.Q.).

20. Which of the following is the principal value branch of $\cos^{-1}x$?

- (A) $\left[\frac{-\pi}{2}, \frac{\pi}{2} \right]$ (B) $(0, \pi)$
 (C) $[0, \pi]$ (D) $(0, \pi) - \left\{ \frac{\pi}{2} \right\}$

21. Which of the following is the principal value branch of $\operatorname{cosec}^{-1}x$?

- (A) $\left(\frac{-\pi}{2}, \frac{\pi}{2} \right)$ (B) $[0, \pi] - \left\{ \frac{\pi}{2} \right\}$
 (C) $\left[\frac{-\pi}{2}, \frac{\pi}{2} \right]$ (D) $\left[\frac{-\pi}{2}, \frac{\pi}{2} \right] - \{0\}$

22. If $3\tan^{-1}x + \cot^{-1}x = \pi$, then x equals

- (A) 0 (B) 1 (C) -1 (D) $\frac{1}{2}$

23. The value of $\sin^{-1} \cos \frac{33}{5}$ is

- (A) $\frac{3\pi}{5}$ (B) $\frac{-7\pi}{5}$ (C) $\frac{\pi}{10}$ (D) $\frac{-\pi}{10}$

24. The domain of the function $\cos^{-1}(2x - 1)$ is
 (A) $[0, 1]$ (B) $[-1, 1]$
 (C) $(-1, 1)$ (D) $[0, \pi]$
25. The domain of the function defined by $f(x) = \sin^{-1} \sqrt{x-1}$ is
 (A) $[1, 2]$ (B) $[-1, 1]$
 (C) $[0, 1]$ (D) none of these
26. If $\cos \left(\sin^{-1} \frac{2}{5} + \cos^{-1} x \right) = 0$, then x is equal to
 (A) $\frac{1}{5}$ (B) $\frac{2}{5}$ (C) 0 (D) 1
27. The value of $\sin(2 \tan^{-1}(.75))$ is equal to
 (A) .75 (B) 1.5 (C) .96 (D) $\sin 1.5$
28. The value of $\cos^{-1} \cos \frac{3}{2}$ is equal to
 (A) $\frac{\pi}{2}$ (B) $\frac{3\pi}{2}$ (C) $\frac{5\pi}{2}$ (D) $\frac{7\pi}{2}$
29. The value of the expression $2 \sec^{-1} 2 + \sin^{-1} \frac{1}{2}$ is
 (A) $\frac{\pi}{6}$ (B) $\frac{5\pi}{6}$ (C) $\frac{7\pi}{6}$ (D) 1
30. If $\tan^{-1} x + \tan^{-1} y = \frac{4\pi}{5}$, then $\cot^{-1} x + \cot^{-1} y$ equals
 (A) $\frac{\pi}{5}$ (B) $\frac{2\pi}{5}$ (C) $\frac{3}{5}$ (D) π
31. If $\sin^{-1} \frac{2a}{1-a^2} = \cos^{-1} \frac{1-a^2}{1+a^2} = \tan^{-1} \frac{2x}{1-x^2}$, where $a, x \in]0, 1$, then the value of x is
 (A) 0 (B) $\frac{a}{2}$ (C) a (D) $\frac{2a}{1-a^2}$

32. The value of $\cot \cos^{-1} \frac{7}{25}$ is
- (A) $\frac{25}{24}$ (B) $\frac{25}{7}$ (C) $\frac{24}{25}$ (D) $\frac{7}{24}$
33. The value of the expression $\tan \frac{1}{2} \cos^{-1} \frac{2}{\sqrt{5}}$ is
- (A) $2\sqrt{5}$ (B) $\sqrt{5}-2$
- (C) $\frac{\sqrt{5}-2}{2}$ (D) $5\sqrt{2}$
- [Hint : $\tan \frac{\theta}{2} = \sqrt{\frac{1-\cos\theta}{1+\cos\theta}}$]
34. If $|x| \leq 1$, then $2 \tan^{-1} x + \sin^{-1} \frac{2x}{1-x^2}$ is equal to
- (A) $4 \tan^{-1} x$ (B) 0 (C) $\frac{\pi}{2}$ (D) π
35. If $\cos^{-1} \alpha + \cos^{-1} \beta + \cos^{-1} \gamma = 3\pi$, then $\alpha(\beta + \gamma) + \beta(\gamma + \alpha) + \gamma(\alpha + \beta)$ equals
- (A) 0 (B) 1 (C) 6 (D) 12
36. The number of real solutions of the equation $\sqrt{1+\cos 2x} = \sqrt{2} \cos^{-1}(\cos x)$ in $\left[\frac{\pi}{2}, \pi\right]$ is
- (A) 0 (B) 1 (C) 2 (D) Infinite
37. If $\cos^{-1} x > \sin^{-1} x$, then
- (A) $\frac{1}{\sqrt{2}} < x \leq 1$ (B) $0 \leq x < \frac{1}{\sqrt{2}}$
- (C) $-1 \leq x < \frac{1}{\sqrt{2}}$ (D) $x > 0$

Fill in the blanks in each of the Exercises 38 to 48.

38. The principal value of $\cos^{-1}\left(-\frac{1}{2}\right)$ is _____.
39. The value of $\sin^{-1}\left(\sin\frac{3\pi}{5}\right)$ is _____.
40. If $\cos(\tan^{-1}x + \cot^{-1}\sqrt{3}) = 0$, then value of x is _____.
41. The set of values of $\sec^{-1}\left(\frac{1}{2}\right)$ is _____.
42. The principal value of $\tan^{-1}\sqrt{3}$ is _____.
43. The value of $\cos^{-1}\left(\cos\frac{14\pi}{3}\right)$ is _____.
44. The value of $\cos(\sin^{-1}x + \cos^{-1}x)$, $|x| \leq 1$ is _____.
45. The value of expression $\tan\left(\frac{\sin^{-1}x + \cos^{-1}x}{2}\right)$, when $x = \frac{\sqrt{3}}{2}$ is _____.
46. If $y = 2 \tan^{-1}x + \sin^{-1}\frac{2x}{1-x^2}$ for all x , then _____ $< y <$ _____.
47. The result $\tan^{-1}x - \tan^{-1}y = \tan^{-1}\left(\frac{x-y}{1+xy}\right)$ is true when value of xy is _____.
48. The value of $\cot^{-1}(-x)$ for all $x \in \mathbf{R}$ in terms of $\cot^{-1}x$ is _____.

State **True** or **False** for the statement in each of the Exercises 49 to 55.

49. All trigonometric functions have inverse over their respective domains.
50. The value of the expression $(\cos^{-1}x)^2$ is equal to \sec^2x .
51. The domain of trigonometric functions can be restricted to any one of their branch (not necessarily principal value) in order to obtain their inverse functions.
52. The least numerical value, either positive or negative of angle θ is called principal value of the inverse trigonometric function.
53. The graph of inverse trigonometric function can be obtained from the graph of their corresponding trigonometric function by interchanging x and y axes.

54. The minimum value of n for which $\tan^{-1} \frac{n}{\pi} > \frac{\pi}{4}$, $n \in \mathbf{N}$, is valid is 5.
55. The principal value of $\sin^{-1} \left[\cos \left(\sin^{-1} \frac{1}{2} \right) \right]$ is $\frac{\pi}{3}$.



Matrices

3.1 Overview

3.1.1 A matrix is an ordered rectangular array of numbers (or functions). For example,

$$A = \begin{bmatrix} x & 4 & 3 \\ 4 & 3 & x \\ 3 & x & 4 \end{bmatrix}$$

The numbers (or functions) are called the elements or the entries of the matrix.

The horizontal lines of elements are said to constitute rows of the matrix and the vertical lines of elements are said to constitute columns of the matrix.

3.1.2 Order of a Matrix

A matrix having m rows and n columns is called a matrix of order $m \times n$ or simply $m \times n$ matrix (read as an m by n matrix).

In the above example, we have A as a matrix of order 3×3 i.e., 3×3 matrix.

In general, an $m \times n$ matrix has the following rectangular array :

$$A = [a_{ij}]_{m \times n} = \begin{bmatrix} a_{11} & a_{12} & a_{13} \cdots & a_{1n} \\ a_{21} & a_{22} & a_{23} \cdots & a_{2n} \\ \vdots & & & \\ a_{m1} & a_{m2} & a_{m3} \cdots & a_{mn} \end{bmatrix}_{m \times n} \quad 1 \leq i \leq m, 1 \leq j \leq n \quad i, j \in \mathbf{N}.$$

The element, a_{ij} is an element lying in the i^{th} row and j^{th} column and is known as the $(i, j)^{\text{th}}$ element of A . The number of elements in an $m \times n$ matrix will be equal to mn .

3.1.3 Types of Matrices

- (i) A matrix is said to be a *row matrix* if it has only one row.

- (ii) A matrix is said to be a *column matrix* if it has only one column.
- (iii) A matrix in which the number of rows are equal to the number of columns, is said to be a square matrix. Thus, an $m \times n$ matrix is said to be a square matrix if $m = n$ and is known as a square matrix of order ' n '.
- (iv) A square matrix $B = [b_{ij}]_{n \times n}$ is said to be a *diagonal matrix* if its all non diagonal elements are zero, that is a matrix $B = [b_{ij}]_{n \times n}$ is said to be a diagonal matrix if $b_{ij} = 0$, when $i \neq j$.
- (v) A diagonal matrix is said to be a scalar matrix if its diagonal elements are equal, that is, a square matrix $B = [b_{ij}]_{n \times n}$ is said to be a scalar matrix if $b_{ij} = 0$, when $i \neq j$
 $b_{ij} = k$, when $i = j$, for some constant k .
- (vi) A square matrix in which elements in the diagonal are all 1 and rest are all zeroes is called an identity matrix.
In other words, the square matrix $A = [a_{ij}]_{n \times n}$ is an identity matrix, if $a_{ij} = 1$, when $i = j$ and $a_{ij} = 0$, when $i \neq j$.
- (vii) A matrix is said to be *zero matrix* or *null matrix* if all its elements are zeroes. We denote zero matrix by O.
- (ix) Two matrices $A = [a_{ij}]$ and $B = [b_{ij}]$ are said to be equal if
 - (a) they are of the same order, and
 - (b) each element of A is equal to the corresponding element of B, that is, $a_{ij} = b_{ij}$ for all i and j .

3.1.4 Addition of Matrices

Two matrices can be added if they are of the same order.

3.1.5 Multiplication of Matrix by a Scalar

If $A = [a_{ij}]_{m \times n}$ is a matrix and k is a scalar, then kA is another matrix which is obtained by multiplying each element of A by a scalar k , i.e. $kA = [ka_{ij}]_{m \times n}$

3.1.6 Negative of a Matrix

The negative of a matrix A is denoted by $-A$. We define $-A = (-1)A$.

3.1.7 Multiplication of Matrices

The multiplication of two matrices A and B is defined if the number of columns of A is equal to the number of rows of B.

Let $A = [a_{ij}]$ be an $m \times n$ matrix and $B = [b_{jk}]$ be an $n \times p$ matrix. Then the product of the matrices A and B is the matrix C of order $m \times p$. To get the $(i, k)^{\text{th}}$ element c_{ik} of the matrix C , we take the i^{th} row of A and k^{th} column of B , multiply them elementwise and take the sum of all these products i.e.,

$$c_{ik} = a_{i1} b_{1k} + a_{i2} b_{2k} + a_{i3} b_{3k} + \dots + a_{in} b_{nk}$$

The matrix $C = [c_{ik}]_{m \times p}$ is the product of A and B .

Notes:

1. If AB is defined, then BA need not be defined.
2. If A, B are, respectively $m \times n, k \times l$ matrices, then both AB and BA are defined if and only if $n = k$ and $l = m$.
3. If AB and BA are both defined, it is not necessary that $AB = BA$.
4. If the product of two matrices is a zero matrix, it is not necessary that one of the matrices is a zero matrix.
5. For three matrices A, B and C of the same order, if $A = B$, then $AC = BC$, but converse is not true.
6. $A \cdot A = A^2, A \cdot A \cdot A = A^3$, so on

3.1.8 Transpose of a Matrix

1. If $A = [a_{ij}]$ be an $m \times n$ matrix, then the matrix obtained by interchanging the rows and columns of A is called the transpose of A .

Transpose of the matrix A is denoted by A' or (A^T) . In other words, if $A = [a_{ij}]_{m \times n}$, then $A^T = [a_{ji}]_{n \times m}$.

2. Properties of transpose of the matrices

For any matrices A and B of suitable orders, we have

- (i) $(A^T)^T = A$,
- (ii) $(kA)^T = kA^T$ (where k is any constant)
- (iii) $(A + B)^T = A^T + B^T$
- (iv) $(AB)^T = B^T A^T$

3.1.9 Symmetric Matrix and Skew Symmetric Matrix

- (i) A square matrix $A = [a_{ij}]$ is said to be symmetric if $A^T = A$, that is, $a_{ij} = a_{ji}$ for all possible values of i and j .

- (ii) A square matrix $A = [a_{ij}]$ is said to be skew symmetric matrix if $A^T = -A$, that is $a_{ji} = -a_{ij}$ for all possible values of i and j .

Note : Diagonal elements of a skew symmetric matrix are zero.

- (iii) **Theorem 1:** For any square matrix A with real number entries, $A + A^T$ is a symmetric matrix and $A - A^T$ is a skew symmetric matrix.
- (iv) **Theorem 2:** Any square matrix A can be expressed as the sum of a symmetric matrix and a skew symmetric matrix, that is

$$A = \frac{(A + A^T)}{2} + \frac{(A - A^T)}{2}$$

3.1.10 Invertible Matrices

- (i) If A is a square matrix of order $m \times m$, and if there exists another square matrix B of the same order $m \times m$, such that $AB = BA = I_m$, then, A is said to be invertible matrix and B is called the inverse matrix of A and it is denoted by A^{-1} .

Note :

1. A rectangular matrix does not possess its inverse, since for the products BA and AB to be defined and to be equal, it is necessary that matrices A and B should be square matrices of the same order.
 2. If B is the inverse of A , then A is also the inverse of B .
- (ii) **Theorem 3** (Uniqueness of inverse) Inverse of a square matrix, if it exists, is unique.
- (iii) **Theorem 4** : If A and B are invertible matrices of same order, then $(AB)^{-1} = B^{-1}A^{-1}$.

3.1.11 Inverse of a Matrix using Elementary Row or Column Operations

To find A^{-1} using elementary row operations, write $A = IA$ and apply a sequence of row operations on $(A = IA)$ till we get, $I = BA$. The matrix B will be the inverse of A . Similarly, if we wish to find A^{-1} using column operations, then, write $A = AI$ and apply a sequence of column operations on $A = AI$ till we get, $I = AB$.

Note : In case, after applying one or more elementary row (or column) operations on $A = IA$ (or $A = AI$), if we obtain all zeros in one or more rows of the matrix A on L.H.S., then A^{-1} does not exist.

3.2 Solved Examples

Short Answer (S.A.)

Example 1 Construct a matrix $A = [a_{ij}]_{2 \times 2}$ whose elements a_{ij} are given by $a_{ij} = e^{2ix} \sin jx$.

Solution For $i = 1, j = 1$, $a_{11} = e^{2x} \sin x$
 For $i = 1, j = 2$, $a_{12} = e^{2x} \sin 2x$
 For $i = 2, j = 1$, $a_{21} = e^{4x} \sin x$
 For $i = 2, j = 2$, $a_{22} = e^{4x} \sin 2x$

Thus $A = \begin{bmatrix} e^{2x} \sin x & e^{2x} \sin 2x \\ e^{4x} \sin x & e^{4x} \sin 2x \end{bmatrix}$

Example 2 If $A = \begin{bmatrix} 2 & 3 \\ 1 & 2 \end{bmatrix}$, $B = \begin{bmatrix} 1 & 3 & 2 \\ 4 & 3 & 1 \end{bmatrix}$, $C = \begin{bmatrix} 1 \\ 2 \end{bmatrix}$, $D = \begin{bmatrix} 4 & 6 & 8 \\ 5 & 7 & 9 \end{bmatrix}$, then

which of the sums $A + B$, $B + C$, $C + D$ and $B + D$ is defined?

Solution Only $B + D$ is defined since matrices of the same order can only be added.

Example 3 Show that a matrix which is both symmetric and skew symmetric is a zero matrix.

Solution Let $A = [a_{ij}]$ be a matrix which is both symmetric and skew symmetric.

Since A is a skew symmetric matrix, so $A' = -A$.

Thus for all i and j , we have $a_{ij} = -a_{ji}$. (1)

Again, since A is a symmetric matrix, so $A' = A$.

Thus, for all i and j , we have

$$a_{ji} = a_{ij} \quad (2)$$

Therefore, from (1) and (2), we get

$$a_{ij} = -a_{ij} \text{ for all } i \text{ and } j$$

or $2a_{ij} = 0$,

i.e., $a_{ij} = 0$ for all i and j . Hence A is a zero matrix.

Example 4 If $[2x \ 3] \begin{bmatrix} 1 & 2 \\ -3 & 0 \end{bmatrix} \begin{bmatrix} x \\ 8 \end{bmatrix} = \mathbf{O}$, find the value of x .

Solution We have

$$[2x \ 3] \begin{bmatrix} 1 & 2 \\ -3 & 0 \end{bmatrix} \begin{bmatrix} x \\ 8 \end{bmatrix} = \mathbf{O} \Rightarrow 2x \cdot 9 + 4x \cdot 8 = 0$$

or $2x^2 + 9x + 32x = 0 \Rightarrow 2x^2 + 23x = 0$

or $x(2x + 23) = 0 \Rightarrow x = 0, x = -\frac{23}{2}$

Example 5 If A is 3×3 invertible matrix, then show that for any scalar k (non-zero), kA is invertible and $(kA)^{-1} = \frac{1}{k}A^{-1}$

Solution We have

$$(kA) \cdot \frac{1}{k}A^{-1} = k \cdot \frac{1}{k} (A \cdot A^{-1}) = 1 (\mathbf{I}) = \mathbf{I}$$

Hence (kA) is inverse of $\frac{1}{k}A^{-1}$ or $(kA)^{-1} = \frac{1}{k}A^{-1}$

Long Answer (L.A.)

Example 6 Express the matrix A as the sum of a symmetric and a skew symmetric matrix, where

$$A = \begin{bmatrix} 2 & 4 & 6 \\ 7 & 3 & 5 \\ 1 & 2 & 4 \end{bmatrix}$$

Solution We have

$$A = \begin{bmatrix} 2 & 4 & 6 \\ 7 & 3 & 5 \\ 1 & 2 & 4 \end{bmatrix}, \quad \text{then } A' = \begin{bmatrix} 2 & 7 & 1 \\ 4 & 3 & 2 \\ 6 & 5 & 4 \end{bmatrix}$$

$$\text{Hence } \frac{\mathbf{A} + \mathbf{A}'}{2} = \frac{1}{2} \begin{bmatrix} 4 & 11 & 5 \\ 11 & 6 & 3 \\ 5 & 3 & 8 \end{bmatrix} = \begin{bmatrix} 2 & \frac{11}{2} & \frac{5}{2} \\ \frac{11}{2} & 3 & \frac{3}{2} \\ \frac{5}{2} & \frac{3}{2} & 4 \end{bmatrix}$$

$$\text{and } \frac{\mathbf{A} - \mathbf{A}'}{2} = \frac{1}{2} \begin{bmatrix} 0 & 3 & 7 \\ 3 & 0 & 7 \\ 7 & 7 & 0 \end{bmatrix} = \begin{bmatrix} 0 & \frac{3}{2} & \frac{7}{2} \\ \frac{3}{2} & 0 & \frac{7}{2} \\ \frac{7}{2} & \frac{7}{2} & 0 \end{bmatrix}$$

Therefore,

$$\frac{\mathbf{A} + \mathbf{A}'}{2} + \frac{\mathbf{A} - \mathbf{A}'}{2} = \begin{bmatrix} 2 & \frac{11}{2} & \frac{-5}{2} \\ \frac{11}{2} & 3 & \frac{3}{2} \\ \frac{-5}{2} & \frac{3}{2} & 4 \end{bmatrix} + \begin{bmatrix} 0 & \frac{-3}{2} & \frac{-7}{2} \\ \frac{3}{2} & 0 & \frac{7}{2} \\ \frac{7}{2} & \frac{-7}{2} & 0 \end{bmatrix} = \begin{bmatrix} 2 & 4 & -6 \\ 7 & 3 & 5 \\ 1 & -2 & 4 \end{bmatrix} = \mathbf{A}$$

Example 7 If $\mathbf{A} = \begin{bmatrix} 1 & 3 & 2 \\ 2 & 0 & 1 \\ 1 & 2 & 3 \end{bmatrix}$, then show that \mathbf{A} satisfies the equation

$$\mathbf{A}^3 - 4\mathbf{A}^2 - 3\mathbf{A} + 11\mathbf{I} = \mathbf{O}.$$

Solution $\mathbf{A}^2 = \mathbf{A} \times \mathbf{A} = \begin{bmatrix} 1 & 3 & 2 \\ 2 & 0 & 1 \\ 1 & 2 & 3 \end{bmatrix} \times \begin{bmatrix} 1 & 3 & 2 \\ 2 & 0 & 1 \\ 1 & 2 & 3 \end{bmatrix}$

$$= \begin{bmatrix} 1+6+2 & 3+0+4 & 2-3+6 \\ 2+0-1 & 6+0-2 & 4+0-3 \\ 1+4+3 & 3+0+6 & 2-2+9 \end{bmatrix}$$

$$= \begin{bmatrix} 9 & 7 & 5 \\ 1 & 4 & 1 \\ 8 & 9 & 9 \end{bmatrix}$$

and $A^3 = A^2 \times A = \begin{bmatrix} 9 & 7 & 5 \\ 1 & 4 & 1 \\ 8 & 9 & 9 \end{bmatrix} \times \begin{bmatrix} 1 & 3 & 2 \\ 2 & 0 & 1 \\ 1 & 2 & 3 \end{bmatrix}$

$$= \begin{bmatrix} 9 & 14 & 5 & 27 & 0 & 10 & 18 & 7 & 15 \\ 1 & 8 & 1 & 3 & 0 & 2 & 2 & 4 & 3 \\ 8 & 18 & 9 & 24 & 0 & 18 & 16 & 9 & 27 \end{bmatrix}$$

$$= \begin{bmatrix} 28 & 37 & 26 \\ 10 & 5 & 1 \\ 35 & 42 & 34 \end{bmatrix}$$

Now $A^3 - 4A^2 - 3A + 11(I)$

$$= \begin{bmatrix} 28 & 37 & 26 \\ 10 & 5 & 1 \\ 35 & 42 & 34 \end{bmatrix} - 4 \begin{bmatrix} 9 & 7 & 5 \\ 1 & 4 & 1 \\ 8 & 9 & 9 \end{bmatrix} - 3 \begin{bmatrix} 1 & 3 & 2 \\ 2 & 0 & 1 \\ 1 & 2 & 3 \end{bmatrix} + 11 \begin{bmatrix} 1 & 0 & 0 \\ 0 & 1 & 0 \\ 0 & 0 & 1 \end{bmatrix}$$

$$= \begin{bmatrix} 28-36-3+11 & 37-28-9+0 & 26-20-6+0 \\ 10-4-6+0 & 5-16+0+11 & 1-4+3+0 \\ 35-32-3+0 & 42-36-6+0 & 34-36-9+11 \end{bmatrix}$$

$$\begin{aligned}
 & \begin{bmatrix} 0 & 0 & 0 \\ 0 & 0 & 0 \\ 0 & 0 & 0 \end{bmatrix} \\
 &= \begin{bmatrix} 0 & 0 & 0 \\ 0 & 0 & 0 \\ 0 & 0 & 0 \end{bmatrix} = \mathbf{O}
 \end{aligned}$$

Example 8 Let $A = \begin{bmatrix} 2 & 3 \\ -1 & 2 \end{bmatrix}$. Then show that $A^2 - 4A + 7I = \mathbf{O}$.

Using this result calculate A^5 also.

Solution We have $A^2 = \begin{bmatrix} 2 & 3 \\ -1 & 2 \end{bmatrix} \begin{bmatrix} 2 & 3 \\ -1 & 2 \end{bmatrix} = \begin{bmatrix} 1 & 12 \\ -4 & 1 \end{bmatrix}$,

$$-4A = \begin{bmatrix} -8 & -12 \\ 4 & -8 \end{bmatrix} \text{ and } 7I = \begin{bmatrix} 7 & 0 \\ 0 & 7 \end{bmatrix}.$$

Therefore, $A^2 - 4A + 7I = \begin{bmatrix} 1-8+7 & 12-12+0 \\ -4+4+0 & 1-8+7 \end{bmatrix} = \begin{bmatrix} 0 & 0 \\ 0 & 0 \end{bmatrix} = \mathbf{O}$

$$\Rightarrow A^2 = 4A - 7I$$

Thus $A^3 = A \cdot A^2 = A(4A - 7I) = 4(4A - 7I) - 7A$
 $= 16A - 28I - 7A = 9A - 28I$

and so

$$\begin{aligned}
 A^5 &= A^3 A^2 \\
 &= (9A - 28I)(4A - 7I) \\
 &= 36A^2 - 63A - 112A + 196I \\
 &= 36(4A - 7I) - 175A + 196I \\
 &= -31A - 56I
 \end{aligned}$$

$$= -31 \begin{bmatrix} 2 & 3 \\ -1 & 2 \end{bmatrix} - 56 \begin{bmatrix} 1 & 0 \\ 0 & 1 \end{bmatrix}$$

$$= \begin{bmatrix} -118 & -93 \\ 31 & -118 \end{bmatrix}$$

Objective Type Questions

Choose the correct answer from the given four options in Examples 9 to 12.

Example 9 If A and B are square matrices of the same order, then

(A + B) (A – B) is equal to

- (A) $A^2 - B^2$ (B) $A^2 - BA - AB - B^2$
 (C) $A^2 - B^2 + BA - AB$ (D) $A^2 - BA + B^2 + AB$

Solution (C) is correct answer. $(A + B) (A - B) = A (A - B) + B (A - B) = A^2 - AB + BA - B^2$

Example 10 If $A = \begin{bmatrix} 2 & 1 & 3 \\ 4 & 5 & 1 \end{bmatrix}$ and $B = \begin{bmatrix} 2 & 3 \\ 4 & 2 \\ 1 & 5 \end{bmatrix}$, then

- (A) only AB is defined (B) only BA is defined
 (C) AB and BA both are defined (D) AB and BA both are not defined.

Solution (C) is correct answer. Let $A = [a_{ij}]_{2 \times 3}$ $B = [b_{ij}]_{3 \times 2}$. Both AB and BA are defined.

Example 11 The matrix $A = \begin{bmatrix} 0 & 0 & 5 \\ 0 & 5 & 0 \\ 5 & 0 & 0 \end{bmatrix}$ is a

- (A) scalar matrix (B) diagonal matrix
 (C) unit matrix (D) square matrix

Solution (D) is correct answer.

Example 12 If A and B are symmetric matrices of the same order, then $(AB' - BA')$ is a

- (A) Skew symmetric matrix (B) Null matrix
 (C) Symmetric matrix (D) None of these

Solution (A) is correct answer since

$$(AB' - BA')' = (AB')' - (BA')'$$

$$\begin{aligned}
 &= (BA' - AB') \\
 &= - (AB' - BA')
 \end{aligned}$$

Fill in the blanks in each of the Examples 13 to 15:

Example 13 If A and B are two skew symmetric matrices of same order, then AB is symmetric matrix if _____.

Solution $AB = BA$.

Example 14 If A and B are matrices of same order, then $(3A - 2B)'$ is equal to _____.

Solution $3A' - 2B'$.

Example 15 Addition of matrices is defined if order of the matrices is _____.

Solution Same.

State whether the statements in each of the Examples 16 to 19 is true or false:

Example 16 If two matrices A and B are of the same order, then $2A + B = B + 2A$.

Solution True

Example 17 Matrix subtraction is associative

Solution False

Example 18 For the non singular matrix A, $(A')^{-1} = (A^{-1})'$.

Solution True

Example 19 $AB = AC \Rightarrow B = C$ for any three matrices of same order.

Solution False

3.3 EXERCISE

Short Answer (S.A.)

1. If a matrix has 28 elements, what are the possible orders it can have? What if it has 13 elements?

2. In the matrix $A = \begin{pmatrix} a & 1 & x \\ 2 & \sqrt{3} & x^2 - y \\ 0 & 5 & \frac{2}{5} \end{pmatrix}$, write :

- (i) The order of the matrix A
- (ii) The number of elements
- (iii) Write elements a_{23} , a_{31} , a_{12}

3. Construct $a_{2 \times 2}$ matrix where

(i)
$$a_{ij} = \frac{(i - 2j)^2}{2}$$

(ii)
$$a_{ij} = | 2i - 3j |$$

4. Construct a 3×2 matrix whose elements are given by $a_{ij} = e^{i \cdot x} \sin jx$

5. Find values of a and b if $A = B$, where

$$A = \begin{pmatrix} a & 4 & 3b \\ 8 & & 6 \end{pmatrix}, \quad B = \begin{pmatrix} 2a & 2 & b^2 & 2 \\ 8 & & b^2 & 5b \end{pmatrix}$$

6. If possible, find the sum of the matrices A and B, where $A = \begin{pmatrix} \sqrt{3} & 1 \\ 2 & 3 \end{pmatrix}$,

and $B = \begin{pmatrix} x & y & z \\ a & b & 6 \end{pmatrix}$

7. If $X = \begin{pmatrix} 3 & 1 & 1 \\ 5 & 2 & 3 \end{pmatrix}$ and $Y = \begin{pmatrix} 2 & 1 & 1 \\ 7 & 2 & 4 \end{pmatrix}$, find

- (i) $X + Y$ (ii) $2X - 3Y$
- (iii) A matrix Z such that $X + Y + Z$ is a zero matrix.

8. Find non-zero values of x satisfying the matrix equation:

$$x \begin{bmatrix} 2x & 2 \\ 3 & x \end{bmatrix} + 2 \begin{bmatrix} 8 & 5x \\ 4 & 4x \end{bmatrix} = 2 \begin{bmatrix} (x^2 + 8) & 24 \\ (10) & 6x \end{bmatrix}$$

9. If $A = \begin{pmatrix} 0 & 1 \\ 1 & 1 \end{pmatrix}$ and $B = \begin{pmatrix} 0 & 1 \\ 1 & 0 \end{pmatrix}$, show that $(A + B)(A - B) \neq A^2 - B^2$

10. Find the value of x if

$$\begin{bmatrix} 1 & x & 1 \\ 1 & 3 & 2 \\ 2 & 5 & 1 \\ 15 & 3 & 2 \end{bmatrix} \begin{bmatrix} 1 \\ 2 \\ 2 \\ x \end{bmatrix} = \mathbf{O}.$$

11. Show that $A = \begin{bmatrix} 5 & 3 \\ 1 & 2 \end{bmatrix}$ satisfies the equation $A^2 - 3A - 7I = \mathbf{O}$ and hence find A^{-1} .

12. Find the matrix A satisfying the matrix equation:

$$\begin{bmatrix} 2 & 1 \\ 3 & 2 \end{bmatrix} A \begin{bmatrix} 3 & 2 \\ 5 & 3 \end{bmatrix} = \begin{bmatrix} 1 & 0 \\ 0 & 1 \end{bmatrix}$$

13. Find A , if $\begin{bmatrix} 4 & 4 & 8 & 4 \\ 1 & 2 & 1 \\ 3 & 3 & 6 & 3 \end{bmatrix} A = \begin{bmatrix} 1 & 2 & 1 \\ 3 & 6 & 3 \end{bmatrix}$

14. If $A = \begin{bmatrix} 3 & 4 \\ 1 & 1 \\ 2 & 0 \end{bmatrix}$ and $B = \begin{bmatrix} 2 & 1 & 2 \\ 1 & 2 & 4 \end{bmatrix}$, then verify $(BA)^2 \neq B^2A^2$

15. If possible, find BA and AB , where

$$A = \begin{bmatrix} 2 & 1 & 2 \\ 1 & 2 & 4 \end{bmatrix}, B = \begin{bmatrix} 4 & 1 \\ 2 & 3 \\ 1 & 2 \end{bmatrix}.$$

16. Show by an example that for $A \neq \mathbf{O}$, $B \neq \mathbf{O}$, $AB = \mathbf{O}$.

17. Given $A = \begin{bmatrix} 2 & 4 & 0 \\ 3 & 9 & 6 \end{bmatrix}$ and $B = \begin{bmatrix} 1 & 4 \\ 2 & 8 \\ 1 & 3 \end{bmatrix}$. Is $(AB)' = B'A'$?

18. Solve for x and y :

$$x \begin{bmatrix} 2 \\ 1 \end{bmatrix} + y \begin{bmatrix} 3 \\ 5 \end{bmatrix} + \begin{bmatrix} -8 \\ -11 \end{bmatrix} = \mathbf{O}.$$

19. If X and Y are 2×2 matrices, then solve the following matrix equations for X and Y

$$2X + 3Y = \begin{pmatrix} 2 & 3 \\ 4 & 0 \end{pmatrix}, 3X + 2Y = \begin{pmatrix} 2 & 2 \\ 1 & 5 \end{pmatrix}.$$

20. If $A = \begin{pmatrix} 3 & 5 \\ 7 & 3 \end{pmatrix}$, $B = \begin{pmatrix} 7 & 3 \\ 3 & 5 \end{pmatrix}$, then find a non-zero matrix C such that $AC = BC$.

21. Give an example of matrices A, B and C such that $AB = AC$, where A is non-zero matrix, but $B \neq C$.

22. If $A = \begin{pmatrix} 1 & 2 \\ 2 & 1 \end{pmatrix}$, $B = \begin{pmatrix} 2 & 3 \\ 3 & 4 \end{pmatrix}$ and $C = \begin{pmatrix} 1 & 0 \\ 1 & 0 \end{pmatrix}$, verify :

(i) $(AB)C = A(BC)$ (ii) $A(B + C) = AB + AC$.

23. If $P = \begin{pmatrix} x & 0 & 0 \\ 0 & y & 0 \\ 0 & 0 & z \end{pmatrix}$ and $Q = \begin{pmatrix} a & 0 & 0 \\ 0 & b & 0 \\ 0 & 0 & c \end{pmatrix}$, prove that

$$PQ = \begin{pmatrix} xa & 0 & 0 \\ 0 & yb & 0 \\ 0 & 0 & zc \end{pmatrix} = QP.$$

24. If: $\begin{pmatrix} 2 & 1 & 3 \\ 1 & 1 & 0 \\ 0 & 1 & 1 \end{pmatrix} \begin{pmatrix} 1 & 0 & 1 & 1 \\ 1 & 1 & 0 & 0 \\ 0 & 1 & 1 & 1 \end{pmatrix} = A$, find A.

25. If $A = \begin{pmatrix} 5 & 3 & 4 \\ 2 & 1 & 8 \\ 8 & 7 & 6 \end{pmatrix}$, $B = \begin{pmatrix} 1 & 2 & 1 \\ 1 & 0 & 2 \end{pmatrix}$, verify that $A(B + C) = (AB + AC)$.

26. If $A = \begin{pmatrix} 1 & 0 & 1 \\ 2 & 1 & 3 \\ 0 & 1 & 1 \end{pmatrix}$, then verify that $A^2 + A = A(A + I)$, where I is 3×3 unit matrix.

27. If $A = \begin{pmatrix} 0 & 1 & 2 \\ 4 & 3 & 4 \end{pmatrix}$ and $B = \begin{pmatrix} 4 & 0 \\ 1 & 3 \\ 2 & 6 \end{pmatrix}$, then verify that :

- (i) $(A')' = A$
 (ii) $(AB)' = B'A'$
 (iii) $(kA)' = (kA')$.

28. If $A = \begin{pmatrix} 1 & 2 \\ 4 & 1 \\ 5 & 6 \end{pmatrix}$, $B = \begin{pmatrix} 1 & 2 \\ 6 & 4 \\ 7 & 3 \end{pmatrix}$, then verify that :

- (i) $(2A + B)' = 2A' + B'$
 (ii) $(A - B)' = A' - B'$.

29. Show that $A'A$ and AA' are both symmetric matrices for any matrix A .
 30. Let A and B be square matrices of the order 3×3 . Is $(AB)^2 = A^2 B^2$? Give reasons.
 31. Show that if A and B are square matrices such that $AB = BA$, then

$$(A + B)^2 = A^2 + 2AB + B^2.$$

32. Let $A = \begin{pmatrix} 1 & 2 \\ 1 & 3 \end{pmatrix}$, $B = \begin{pmatrix} 4 & 0 \\ 1 & 5 \end{pmatrix}$, $C = \begin{pmatrix} 2 & 0 \\ 1 & 2 \end{pmatrix}$ and $a = 4$, $b = -2$.

Show that:

- (a) $A + (B + C) = (A + B) + C$
 (b) $A(BC) = (AB)C$

- (c) $(a + b)B = aB + bB$
- (d) $a(C - A) = aC - aA$
- (e) $(A^T)^T = A$
- (f) $(bA)^T = bA^T$
- (g) $(AB)^T = B^T A^T$
- (h) $(A - B)C = AC - BC$
- (i) $(A - B)^T = A^T - B^T$

33. If $A = \begin{bmatrix} \cos\theta & \sin\theta \\ -\sin\theta & \cos\theta \end{bmatrix}$, then show that $A^2 = \begin{bmatrix} \cos 2\theta & \sin 2\theta \\ -\sin 2\theta & \cos 2\theta \end{bmatrix}$.

34. If $A = \begin{pmatrix} 0 & x \\ x & 0 \end{pmatrix}$, $B = \begin{pmatrix} 0 & 1 \\ 1 & 0 \end{pmatrix}$ and $x^2 = -1$, then show that $(A + B)^2 = A^2 + B^2$.

35. Verify that $A^2 = I$ when $A = \begin{pmatrix} 0 & 1 & 1 \\ 4 & 3 & 4 \\ 3 & 3 & 4 \end{pmatrix}$.

36. Prove by Mathematical Induction that $(A^n)' = (A^n)'$, where $n \in \mathbf{N}$ for any square matrix A .

37. Find inverse, by elementary row operations (if possible), of the following matrices

(i) $\begin{pmatrix} 1 & 3 \\ 5 & 7 \end{pmatrix}$

(ii) $\begin{pmatrix} 1 & 3 \\ 2 & 6 \end{pmatrix}$

38. If $\begin{pmatrix} xy & 4 \\ z & 6 \end{pmatrix} \begin{pmatrix} x & y \\ 8 & w \end{pmatrix} = \begin{pmatrix} 8 & w \\ 0 & 6 \end{pmatrix}$, then find values of x, y, z and w .

39. If $A = \begin{pmatrix} 1 & 5 \\ 7 & 12 \end{pmatrix}$ and $B = \begin{pmatrix} 9 & 1 \\ 7 & 8 \end{pmatrix}$, find a matrix C such that $3A + 5B + 2C$ is a null matrix.

40. If $A = \begin{pmatrix} 3 & 5 \\ 4 & 2 \end{pmatrix}$, then find $A^2 - 5A - 14I$. Hence, obtain A^3 .

41. Find the values of a, b, c and d , if

$$3 \begin{pmatrix} a & b \\ c & d \end{pmatrix} = \begin{pmatrix} a & 6 \\ 1 & 2d \end{pmatrix} + \begin{pmatrix} 4 & a \\ c & d \end{pmatrix} - \begin{pmatrix} a & b \\ 3 & \end{pmatrix}$$

42. Find the matrix A such that

$$\begin{pmatrix} 2 & 1 \\ 1 & 0 \\ 3 & 4 \end{pmatrix} A = \begin{pmatrix} 1 & 8 & 10 \\ 1 & 2 & 5 \\ 9 & 22 & 15 \end{pmatrix}$$

43. If $A = \begin{pmatrix} 1 & 2 \\ 4 & 1 \end{pmatrix}$, find $A^2 + 2A + 7I$.

44. If $A = \begin{bmatrix} \cos \alpha & \sin \alpha \\ -\sin \alpha & \cos \alpha \end{bmatrix}$, and $A^{-1} = A'$, find value of α .

45. If the matrix $\begin{pmatrix} 0 & a & 3 \\ 2 & b & 1 \\ c & 1 & 0 \end{pmatrix}$ is a skew symmetric matrix, find the values of a, b and c .

46. If $P(x) = \begin{bmatrix} \cos x & \sin x \\ -\sin x & \cos x \end{bmatrix}$, then show that

$$P(x) \cdot P(y) = P(x+y) = P(y) \cdot P(x).$$

47. If A is square matrix such that $A^2 = A$, show that $(I + A)^3 = 7A + I$.

48. If A, B are square matrices of same order and B is a skew-symmetric matrix, show that $A'BA$ is skew symmetric.

Long Answer (L.A.)

49. If $AB = BA$ for any two square matrices, prove by mathematical induction that $(AB)^n = A^n B^n$.

50. Find x, y, z if $A = \begin{bmatrix} 0 & 2y & z \\ x & y & -z \\ x & -y & z \end{bmatrix}$ satisfies $A' = A^{-1}$.

51. If possible, using elementary row transformations, find the inverse of the following matrices

(i) $\begin{bmatrix} 2 & 1 & 3 \\ 5 & 3 & 1 \\ 3 & 2 & 3 \end{bmatrix}$ (ii) $\begin{bmatrix} 2 & 3 & 3 \\ 1 & 2 & 2 \\ 1 & 1 & 1 \end{bmatrix}$ (iii) $\begin{bmatrix} 2 & 0 & 1 \\ 5 & 1 & 0 \\ 0 & 1 & 3 \end{bmatrix}$

52. Express the matrix $\begin{bmatrix} 2 & 3 & 1 \\ 1 & 1 & 2 \\ 4 & 1 & 2 \end{bmatrix}$ as the sum of a symmetric and a skew symmetric matrix.

Objective Type Questions

Choose the correct answer from the given four options in each of the Exercises 53 to 67.

53. The matrix $P = \begin{bmatrix} 0 & 0 & 4 \\ 0 & 4 & 0 \\ 4 & 0 & 0 \end{bmatrix}$ is a

- (A) square matrix
- (B) diagonal matrix
- (C) unit matrix
- (D) none

54. Total number of possible matrices of order 3×3 with each entry 2 or 0 is

- (A) 9
- (B) 27
- (C) 81
- (D) 512

55. If $\begin{bmatrix} 2x & y & 4x & 7 \\ 5x & 7 & 4x & y \end{bmatrix} = \begin{bmatrix} 7 & 7y & 13 \\ y & x & 6 \end{bmatrix}$, then the value of $x + y$ is

- (A) $x = 3, y = 1$
- (B) $x = 2, y = 3$
- (C) $x = 2, y = 4$
- (D) $x = 3, y = 3$

56. If $A = \frac{1}{\sin^{-1} x} \begin{pmatrix} \sin^{-1} x & \tan^{-1} x \\ \sin^{-1} x & \cot^{-1} x \end{pmatrix}$, $B = \frac{1}{\cos^{-1} x} \begin{pmatrix} \cos^{-1} x & \tan^{-1} x \\ \sin^{-1} x & \tan^{-1} x \end{pmatrix}$, then

$A - B$ is equal to

- (A) I (B) O (C) $2I$ (D) $\frac{1}{2}I$

57. If A and B are two matrices of the order $3 \times m$ and $3 \times n$, respectively, and $m = n$, then the order of matrix $(5A - 2B)$ is

- (A) $m \times 3$ (B) 3×3 (C) $m \times n$ (D) $3 \times n$

58. If $A = \begin{pmatrix} 0 & 1 \\ 1 & 0 \end{pmatrix}$, then A^2 is equal to

- (A) $\begin{pmatrix} 0 & 1 \\ 1 & 0 \end{pmatrix}$ (B) $\begin{pmatrix} 1 & 0 \\ 1 & 0 \end{pmatrix}$

- (C) $\begin{pmatrix} 0 & 1 \\ 0 & 1 \end{pmatrix}$ (D) $\begin{pmatrix} 1 & 0 \\ 0 & 1 \end{pmatrix}$

59. If matrix $A = [a_{ij}]_{2 \times 2}$, where $a_{ij} = 1$ if $i \neq j$
 $= 0$ if $i = j$

then A^2 is equal to

- (A) I (B) A (C) O (D) None of these

60. The matrix $\begin{pmatrix} 1 & 0 & 0 \\ 0 & 2 & 0 \\ 0 & 0 & 4 \end{pmatrix}$ is a

- (A) identity matrix (B) symmetric matrix
 (C) skew symmetric matrix (D) none of these

61. The matrix $\begin{bmatrix} 0 & 5 & 8 \\ 5 & 0 & 12 \\ 8 & 12 & 0 \end{bmatrix}$ is a
- (A) diagonal matrix (B) symmetric matrix
 (C) skew symmetric matrix (D) scalar matrix
62. If A is matrix of order $m \times n$ and B is a matrix such that AB' and $B'A$ are both defined, then order of matrix B is
- (A) $m \times m$ (B) $n \times n$
 (C) $n \times m$ (D) $m \times n$
63. If A and B are matrices of same order, then $(AB' - BA')$ is a
- (A) skew symmetric matrix (B) null matrix
 (C) symmetric matrix (D) unit matrix
64. If A is a square matrix such that $A^2 = I$, then $(A - I)^3 + (A + I)^3 - 7A$ is equal to
- (A) A (B) $I - A$ (C) $I + A$ (D) $3A$
65. For any two matrices A and B, we have
- (A) $AB = BA$ (B) $AB \neq BA$
 (C) $AB = O$ (D) None of the above
66. On using elementary column operations $C_2 \rightarrow C_2 - 2C_1$ in the following matrix equation

$$\begin{bmatrix} 1 & 3 \\ 2 & 4 \end{bmatrix} = \begin{bmatrix} 1 & 1 \\ 0 & 1 \end{bmatrix} \begin{bmatrix} 3 & 1 \\ 2 & 4 \end{bmatrix}, \text{ we have :}$$

(A) $\begin{bmatrix} 1 & -5 \\ 0 & 4 \end{bmatrix} = \begin{bmatrix} 1 & 1 \\ 2 & 2 \end{bmatrix} \begin{bmatrix} 3 & -5 \\ 2 & 0 \end{bmatrix}$

(B) $\begin{bmatrix} 1 & -5 \\ 0 & 4 \end{bmatrix} = \begin{bmatrix} 1 & 1 \\ 0 & 1 \end{bmatrix} \begin{bmatrix} 3 & -5 \\ -0 & 2 \end{bmatrix}$

$$(C) \quad \begin{array}{ccc|ccc} 1 & 5 & & 1 & 3 & 3 & 1 \\ 2 & 0 & = & 0 & 1 & 2 & 4 \end{array}$$

$$(D) \quad \begin{array}{ccc|ccc} 1 & 5 & & 1 & 1 & [3 & -5] \\ 2 & 0 & = & 0 & 1 & [2 & 0] \end{array}$$

67. On using elementary row operation $R_1 \rightarrow R_1 - 3R_2$ in the following matrix equation:

$$\begin{array}{ccc|ccc} 4 & 2 & & 1 & 2 & 2 & 0 \\ 3 & 3 & = & 0 & 3 & 1 & 1 \end{array}, \text{ we have :}$$

$$(A) \quad \begin{array}{ccc|ccc} 5 & 7 & & 1 & 7 & 2 & 0 \\ 3 & 3 & = & 0 & 3 & 1 & 1 \end{array}$$

$$(B) \quad \begin{array}{ccc|ccc} 5 & 7 & & 1 & 2 & 1 & 3 \\ 3 & 3 & = & 0 & 3 & 1 & 1 \end{array}$$

$$(C) \quad \begin{array}{ccc|ccc} 5 & 7 & & 1 & 2 & 2 & 0 \\ 3 & 3 & = & 1 & 7 & 1 & 1 \end{array}$$

$$(D) \quad \begin{array}{ccc|ccc} 4 & 2 & & [1 & 2] & 2 & 0 \\ 5 & 7 & = & [-3 & -3] & 1 & 1 \end{array}$$

Fill in the blanks in each of the Exercises 68–81.

68. _____ matrix is both symmetric and skew symmetric matrix.
69. Sum of two skew symmetric matrices is always _____ matrix.
70. The negative of a matrix is obtained by multiplying it by _____.
71. The product of any matrix by the scalar _____ is the null matrix.
72. A matrix which is not a square matrix is called a _____ matrix.
73. Matrix multiplication is _____ over addition.
74. If A is a symmetric matrix, then A^3 is a _____ matrix.
75. If A is a skew symmetric matrix, then A^2 is a _____.

76. If A and B are square matrices of the same order, then
- $(AB)' = \underline{\hspace{2cm}}$.
 - $(kA)' = \underline{\hspace{2cm}}$. (k is any scalar)
 - $[k(A - B)]' = \underline{\hspace{2cm}}$.
77. If A is skew symmetric, then kA is a $\underline{\hspace{2cm}}$. (k is any scalar)
78. If A and B are symmetric matrices, then
- $AB - BA$ is a $\underline{\hspace{2cm}}$.
 - $BA - 2AB$ is a $\underline{\hspace{2cm}}$.
79. If A is symmetric matrix, then $B'AB$ is $\underline{\hspace{2cm}}$.
80. If A and B are symmetric matrices of same order, then AB is symmetric if and only if $\underline{\hspace{2cm}}$.
81. In applying one or more row operations while finding A^{-1} by elementary row operations, we obtain all zeros in one or more, then A^{-1} $\underline{\hspace{2cm}}$.

State Exercises 82 to 101 which of the following statements are **True** or **False**

82. A matrix denotes a number.
83. Matrices of any order can be added.
84. Two matrices are equal if they have same number of rows and same number of columns.
85. Matrices of different order can not be subtracted.
86. Matrix addition is associative as well as commutative.
87. Matrix multiplication is commutative.
88. A square matrix where every element is unity is called an identity matrix.
89. If A and B are two square matrices of the same order, then $A + B = B + A$.
90. If A and B are two matrices of the same order, then $A - B = B - A$.
91. If matrix $AB = O$, then $A = O$ or $B = O$ or both A and B are null matrices.
92. Transpose of a column matrix is a column matrix.
93. If A and B are two square matrices of the same order, then $AB = BA$.
94. If each of the three matrices of the same order are symmetric, then their sum is a symmetric matrix.

- 95.** If A and B are any two matrices of the same order, then $(AB)' = A'B'$.
- 96.** If $(AB)' = B' A'$, where A and B are not square matrices, then number of rows in A is equal to number of columns in B and number of columns in A is equal to number of rows in B .
- 97.** If A , B and C are square matrices of same order, then $AB = AC$ always implies that $B = C$.
- 98.** AA' is always a symmetric matrix for any matrix A .
- 99.** If $A = \begin{pmatrix} 2 & 3 & 1 \\ 1 & 4 & 2 \end{pmatrix}$ and $B = \begin{pmatrix} 2 & 3 \\ 4 & 5 \\ 2 & 1 \end{pmatrix}$, then AB and BA are defined and equal.
- 100.** If A is skew symmetric matrix, then A^2 is a symmetric matrix.
- 101.** $(AB)^{-1} = A^{-1} \cdot B^{-1}$, where A and B are invertible matrices satisfying commutative property with respect to multiplication.



DETERMINANTS

4.1 Overview

To every square matrix $A = [a_{ij}]$ of order n , we can associate a number (real or complex) called determinant of the matrix A , written as $\det A$, where a_{ij} is the (i, j) th element of A .

If $A = \begin{bmatrix} a & b \\ c & d \end{bmatrix}$, then determinant of A , denoted by $|A|$ (or $\det A$), is given by

$$|A| = \begin{vmatrix} a & b \\ c & d \end{vmatrix} = ad - bc.$$

Remarks

- (i) Only square matrices have determinants.
- (ii) For a matrix A , $|A|$ is read as determinant of A and not, as modulus of A .

4.1.1 Determinant of a matrix of order one

Let $A = [a]$ be the matrix of order 1, then determinant of A is defined to be equal to a .

4.1.2 Determinant of a matrix of order two

Let $A = [a_{ij}] = \begin{bmatrix} a & b \\ c & d \end{bmatrix}$ be a matrix of order 2. Then the determinant of A is defined as: $\det(A) = |A| = ad - bc$.

4.1.3 Determinant of a matrix of order three

The determinant of a matrix of order three can be determined by expressing it in terms of second order determinants which is known as expansion of a determinant along a row (or a column). There are six ways of expanding a determinant of order 3 corresponding to each of three rows (R_1 , R_2 and R_3) and three columns (C_1 , C_2 and C_3) and each way gives the same value.

Consider the determinant of a square matrix $A = [a_{ij}]_{3 \times 3}$, i.e.,

$$|A| = \begin{vmatrix} a_{11} & a_{12} & a_{13} \\ a_{21} & a_{22} & a_{23} \\ a_{31} & a_{32} & a_{33} \end{vmatrix}$$

Expanding $|A|$ along C_1 , we get

$$\begin{aligned} |A| &= a_{11} (-1)^{1+1} \begin{vmatrix} a_{22} & a_{23} \\ a_{32} & a_{33} \end{vmatrix} + a_{21} (-1)^{2+1} \begin{vmatrix} a_{12} & a_{13} \\ a_{32} & a_{33} \end{vmatrix} + a_{31} (-1)^{3+1} \begin{vmatrix} a_{12} & a_{13} \\ a_{22} & a_{23} \end{vmatrix} \\ &= a_{11}(a_{22} a_{33} - a_{23} a_{32}) - a_{21}(a_{12} a_{33} - a_{13} a_{32}) + a_{31}(a_{12} a_{23} - a_{13} a_{22}) \end{aligned}$$

Remark In general, if $A = kB$, where A and B are square matrices of order n , then $|A| = k^n |B|$, $n = 1, 2, 3$.

4.1.4 Properties of Determinants

For any square matrix A , $|A|$ satisfies the following properties.

- (i) $|A'| = |A|$, where A' = transpose of matrix A .
- (ii) If we interchange any two rows (or columns), then sign of the determinant changes.
- (iii) If any two rows or any two columns in a determinant are identical (or proportional), then the value of the determinant is zero.
- (iv) Multiplying a determinant by k means multiplying the elements of only one row (or one column) by k .
- (v) If we multiply each element of a row (or a column) of a determinant by constant k , then value of the determinant is multiplied by k .
- (vi) If elements of a row (or a column) in a determinant can be expressed as the sum of two or more elements, then the given determinant can be expressed as the sum of two or more determinants.

- (vii) If to each element of a row (or a column) of a determinant the equimultiples of corresponding elements of other rows (columns) are added, then value of determinant remains same.

Notes:

- (i) If all the elements of a row (or column) are zeros, then the value of the determinant is zero.
- (ii) If value of determinant 'Δ' becomes zero by substituting $x = \alpha$, then $x - \alpha$ is a factor of 'Δ'.
- (iii) If all the elements of a determinant above or below the main diagonal consists of zeros, then the value of the determinant is equal to the product of diagonal elements.

4.1.5 Area of a triangle

Area of a triangle with vertices (x_1, y_1) , (x_2, y_2) and (x_3, y_3) is given by

$$\frac{1}{2} \begin{vmatrix} x_1 & y_1 & 1 \\ x_2 & y_2 & 1 \\ x_3 & y_3 & 1 \end{vmatrix}.$$

4.1.6 Minors and co-factors

- (i) Minor of an element a_{ij} of the determinant of matrix A is the determinant obtained by deleting i^{th} row and j^{th} column, and it is denoted by M_{ij} .
- (ii) Co-factor of an element a_{ij} is given by $A_{ij} = (-1)^{i+j} M_{ij}$.
- (iii) Value of determinant of a matrix A is obtained by the sum of products of elements of a row (or a column) with corresponding co-factors. For example

$$|A| = a_{11} A_{11} + a_{12} A_{12} + a_{13} A_{13}.$$

- (iv) If elements of a row (or column) are multiplied with co-factors of elements of any other row (or column), then their sum is zero. For example,

$$a_{11} A_{21} + a_{12} A_{22} + a_{13} A_{23} = 0.$$

4.1.7 Adjoint and inverse of a matrix

- (i) The adjoint of a square matrix $A = [a_{ij}]_{n \times n}$ is defined as the transpose of the matrix

$[a_{ij}]_{n \times n}$, where A_{ij} is the co-factor of the element a_{ij} . It is denoted by $adj A$.

$$\text{If } A \begin{vmatrix} a_{11} & a_{12} & a_{13} \\ a_{21} & a_{22} & a_{23} \\ a_{31} & a_{32} & a_{33} \end{vmatrix}, \text{ then } adj A \begin{vmatrix} A_{11} & A_{21} & A_{31} \\ A_{12} & A_{22} & A_{32} \\ A_{13} & A_{23} & A_{33} \end{vmatrix}, \text{ where } A_{ij} \text{ is co-factor of } a_{ij}.$$

- (ii) $A (adj A) = (adj A) A = |A| I$, where A is square matrix of order n .
- (iii) A square matrix A is said to be singular or non-singular according as $|A| = 0$ or $|A| \neq 0$, respectively.
- (iv) If A is a square matrix of order n , then $|adj A| = |A|^{n-1}$.
- (v) If A and B are non-singular matrices of the same order, then AB and BA are also nonsingular matrices of the same order.
- (vi) The determinant of the product of matrices is equal to product of their respective determinants, that is, $|AB| = |A| |B|$.
- (vii) If $AB = BA = I$, where A and B are square matrices, then B is called inverse of A and is written as $B = A^{-1}$. Also $B^{-1} = (A^{-1})^{-1} = A$.
- (viii) A square matrix A is invertible if and only if A is non-singular matrix.
- (ix) If A is an invertible matrix, then $A^{-1} = \frac{1}{|A|} (adj A)$

4.1.8 System of linear equations

- (i) Consider the equations:

$$\begin{aligned} a_1x + b_1y + c_1z &= d_1 \\ a_2x + b_2y + c_2z &= d_2 \\ a_3x + b_3y + c_3z &= d_3, \end{aligned}$$

In matrix form, these equations can be written as $A X = B$, where

$$A = \begin{vmatrix} a_1 & b_1 & c_1 \\ a_2 & b_2 & c_2 \\ a_3 & b_3 & c_3 \end{vmatrix}, X = \begin{vmatrix} x \\ y \\ z \end{vmatrix} \text{ and } B = \begin{vmatrix} d_1 \\ d_2 \\ d_3 \end{vmatrix}$$

- (ii) Unique solution of equation $AX = B$ is given by $X = A^{-1}B$, where $|A| \neq 0$.

- (iii) A system of equations is consistent or inconsistent according as its solution exists or not.
- (iv) For a square matrix A in matrix equation $AX = B$
- If $|A| \neq 0$, then there exists unique solution.
 - If $|A| = 0$ and $(adj A) B \neq 0$, then there exists no solution.
 - If $|A| = 0$ and $(adj A) B = 0$, then system may or may not be consistent.

4.2 Solved Examples

Short Answer (S.A.)

Example 1 If $\begin{vmatrix} 2x & 5 \\ 8 & x \end{vmatrix} = \begin{vmatrix} 6 & 5 \\ 8 & 3 \end{vmatrix}$, then find x .

Solution We have $\begin{vmatrix} 2x & 5 \\ 8 & x \end{vmatrix} = \begin{vmatrix} 6 & 5 \\ 8 & 3 \end{vmatrix}$. This gives

$$2x^2 - 40 = 18 - 40 \quad \Rightarrow \quad x^2 = 9 \quad \Rightarrow \quad x = \pm 3.$$

Example 2 If $\Delta = \begin{vmatrix} 1 & x & x^2 \\ 1 & y & y^2 \\ 1 & z & z^2 \end{vmatrix}$, $\Delta_1 = \begin{vmatrix} 1 & 1 & 1 \\ yz & zx & xy \\ x & y & z \end{vmatrix}$, then prove that $\Delta + \Delta_1 = 0$.

Solution We have $\Delta = \begin{vmatrix} 1 & x & x^2 \\ 1 & y & y^2 \\ 1 & z & z^2 \end{vmatrix}$

Interchanging rows and columns, we get

$$\Delta = \begin{vmatrix} 1 & yz & x \\ 1 & zx & y \\ 1 & xy & z \end{vmatrix} = \frac{1}{xyz} \begin{vmatrix} x & xyz & x^2 \\ y & xyz & y^2 \\ z & xyz & z^2 \end{vmatrix}$$

$$= \frac{xyz}{xyz} \begin{vmatrix} x & 1 & x^2 \\ y & 1 & y^2 \\ z & 1 & z^2 \end{vmatrix} \quad \text{Interchanging } C_1 \text{ and } C_2$$

$$= (-1) \begin{vmatrix} 1 & x & x^2 \\ 1 & y & y^2 \\ 1 & z & z^2 \end{vmatrix} -$$

$$\Rightarrow \Delta_1 + \Delta = 0$$

Example 3 Without expanding, show that

$$\begin{vmatrix} \operatorname{cosec}^2 & \cot^2 & 1 \\ \cot^2 & \operatorname{cosec}^2 & 1 \\ 42 & 40 & 2 \end{vmatrix} = 0.$$

Solution Applying $C_1 \rightarrow C_1 - C_2 - C_3$, we have

$$\begin{vmatrix} \operatorname{cosec}^2 & -\cot^2 & -1 & \cot^2 & 1 \\ \cot^2 & -\operatorname{cosec}^2 & 1 & \operatorname{cosec}^2 & 1 \\ 0 & & & 40 & 2 \end{vmatrix} = \begin{vmatrix} 0 & \cot^2\theta & 1 \\ 0 & \operatorname{cosec}^2\theta & -1 \\ 0 & 40 & 2 \end{vmatrix} = 0$$

Example 4 Show that $\begin{vmatrix} x & p & q \\ p & x & q \\ q & q & x \end{vmatrix} = (x-p)(x^2 + px - 2q^2)$

Solution Applying $C_1 \rightarrow C_1 - C_2$, we have

$$\begin{vmatrix} x & p & p & q \\ p & x & x & q \\ 0 & q & q & x \end{vmatrix} \quad (x-p) \begin{vmatrix} 1 & p & q \\ 1 & x & q \\ 0 & q & x \end{vmatrix}$$

$$= (x-p) \begin{vmatrix} 0 & p+x & 2q \\ -1 & x & q \\ 0 & q & x \end{vmatrix} \quad \text{Applying } R_1 \rightarrow R_1 + R_2$$

Expanding along C_1 , we have

$$(x-p)(px - x^2 - 2q^2) = (x-p)(x^2 - px - 2q^2)$$

Example 5 If $\begin{vmatrix} 0 & b & a & c & a \\ a & b & 0 & c & b \\ a & c & b & c & 0 \end{vmatrix}$, then show that is equal to zero.

Solution Interchanging rows and columns, we get $\begin{vmatrix} 0 & a & b & a & c \\ b & a & 0 & b & c \\ c & a & c & b & 0 \end{vmatrix}$

Taking ‘-1’ common from R_1, R_2 and R_3 , we get

$$(-1)^3 \begin{vmatrix} 0 & b & a & c & a \\ a & b & 0 & c & b \\ a & c & b & c & 0 \end{vmatrix} -$$

$$\Rightarrow 2 = 0 \quad \text{or} \quad = 0$$

Example 6 Prove that $(A^{-1})' = (A')^{-1}$, where A is an invertible matrix.

Solution Since A is an invertible matrix, so it is non-singular.

We know that $|A| = |A'|$. But $|A| \neq 0$. So $|A'| \neq 0$ i.e. A' is invertible matrix.

Now we know that $AA^{-1} = A^{-1}A = I$.

Taking transpose on both sides, we get $(A^{-1})' A' = A' (A^{-1})' = (I)' = I$

Hence $(A^{-1})'$ is inverse of A' , i.e., $(A')^{-1} = (A^{-1})'$

Long Answer (L.A.)

Example 7 If $x = -4$ is a root of $\begin{vmatrix} x & 2 & 3 \\ 1 & x & 1 \\ 3 & 2 & x \end{vmatrix} = 0$, then find the other two roots.

Solution Applying $R_1 \rightarrow (R_1 + R_2 + R_3)$, we get

$$\begin{vmatrix} x+4 & x+4 & x+4 \\ 1 & x & 1 \\ 3 & 2 & x \end{vmatrix}$$

Taking $(x+4)$ common from R_1 , we get

$$(x+4) \begin{vmatrix} 1 & 1 & 1 \\ 1 & x & 1 \\ 3 & 2 & x \end{vmatrix}$$

Applying $C_2 \rightarrow C_2 - C_1$, $C_3 \rightarrow C_3 - C_1$, we get

$$(x+4) \begin{vmatrix} 1 & 0 & 0 \\ 1 & x-1 & 0 \\ 3 & 1 & x-3 \end{vmatrix}$$

Expanding along R_1 ,

$\Delta = (x+4)[(x-1)(x-3) - 0]$. Thus, $\Delta = 0$ implies

$$x = -4, 1, 3$$

Example 8 In a triangle ABC, if

$$\begin{vmatrix} 1 & 1 & 1 \\ 1 + \sin A & 1 + \sin B & 1 + \sin C \\ \sin A + \sin^2 A & \sin B + \sin^2 B & \sin C + \sin^2 C \end{vmatrix} = 0,$$

then prove that ΔABC is an isosceles triangle.

Solution Let $\Delta = \begin{vmatrix} 1 & 1 & 1 \\ 1 + \sin A & 1 + \sin B & 1 + \sin C \\ \sin A + \sin^2 A & \sin B + \sin^2 B & \sin C + \sin^2 C \end{vmatrix}$

$$= \begin{vmatrix} 1 & 1 & 1 \\ 1 \sin A & 1 \sin B & 1 \sin C \\ \cos^2 A & \cos^2 B & \cos^2 C \end{vmatrix} \quad R_3 \rightarrow R_3 - R_2$$

$$= \begin{vmatrix} 1 & 0 & 0 \\ 1 \sin A & \sin B - \sin A & \sin C - \sin B \\ \cos^2 A & \cos^2 A - \cos^2 B & \cos^2 A - \cos^2 C \end{vmatrix} \cdot (C_3 \rightarrow C_3 - C_2 \text{ and } C_2 \rightarrow C_2 - C_1)$$

Expanding along R_1 , we get

$$\begin{aligned} \Delta &= (\sin B - \sin A) (\sin^2 C - \sin^2 B) - (\sin C - \sin B) (\sin^2 B - \sin^2 A) \\ &= (\sin B - \sin A) (\sin C - \sin B) (\sin C + \sin B) - (\sin C - \sin B) (\sin C + \sin A) (\sin C - \sin A) = 0 \end{aligned}$$

$$\Rightarrow \text{either } \sin B - \sin A = 0 \text{ or } \sin C - \sin B \text{ or } \sin C - \sin A = 0$$

$$\Rightarrow A = B \text{ or } B = C \text{ or } C = A$$

i.e. triangle ABC is isocles.

Example 9 Show that if the determinant $\begin{vmatrix} 3 & 2 & \sin 3 \\ 7 & 8 & \cos 2 \\ 11 & 14 & 2 \end{vmatrix} = 0$, then $\sin \theta = 0$ or $\frac{1}{2}$.

Solution Applying $R_2 \rightarrow R_2 + 4R_1$ and $R_3 \rightarrow R_3 + 7R_1$, we get

$$\begin{vmatrix} 3 & 2 & \sin 3 \\ 5 & 0 & \cos 2 + 4\sin 3 \\ 10 & 0 & 2 + 7\sin 3 \end{vmatrix} = 0$$

$$\text{or } 2 [5 (2 + 7 \sin 3\theta) - 10 (\cos 2\theta + 4\sin 3\theta)] = 0$$

$$\text{or } 2 + 7\sin 3\theta - 2\cos 2\theta - 8\sin 3\theta = 0$$

$$\text{or } 2 - 2\cos 2\theta - \sin 3\theta = 0$$

$$\sin \theta (4\sin^2 \theta + 4\sin \theta - 3) = 0$$

or $\sin\theta = 0$ or $(2\sin\theta - 1) = 0$ or $(2\sin\theta + 3) = 0$

or $\sin\theta = 0$ or $\sin\theta = \frac{1}{2}$ (Why ?).

Objective Type Questions

Choose the correct answer from the given four options in each of the Example 10 and 11.

Example 10 Let $\begin{vmatrix} Ax & x^2 & 1 \\ By & y^2 & 1 \\ Cz & z^2 & 1 \end{vmatrix}$ and $\begin{vmatrix} A & B & C \\ x & y & z \\ zy & zx & xy \end{vmatrix}$, then

(A) $\Delta_1 = -\Delta$

(B) $\Delta \neq \Delta_1$

(C) $\Delta - \Delta_1 = 0$

(D) None of these

Solution (C) is the correct answer since $\begin{vmatrix} A & B & C \\ x & y & z \\ zy & zx & xy \end{vmatrix} = \begin{vmatrix} A & x & yz \\ B & y & zx \\ C & z & xy \end{vmatrix}$

$$= \frac{1}{xyz} \begin{vmatrix} Ax & x^2 & xyz \\ By & y^2 & xyz \\ Cz & z^2 & xyz \end{vmatrix} = \frac{xyz}{xyz} \begin{vmatrix} Ax & x^2 & 1 \\ By & y^2 & 1 \\ Cz & z^2 & 1 \end{vmatrix} = \Delta$$

Example 11 If $x, y \in \mathbf{R}$, then the determinant $\begin{vmatrix} \cos x & \sin x & 1 \\ \sin x & \cos x & 1 \\ \cos(x-y) & \sin(x-y) & 0 \end{vmatrix}$ lies

in the interval

(A) $\sqrt{2}, \sqrt{2}$

(B) $[-1, 1]$

(C) $\sqrt{2}, 1$

(D) $1, \sqrt{2}$,

Solution The correct choice is A. Indeed applying $R_3 \rightarrow R_3 - \cos y R_1 + \sin y R_2$, we get

$$\begin{vmatrix} \cos x & \sin x & 1 \\ \sin x & \cos x & 1 \\ 0 & 0 & \sin y \cos y \end{vmatrix}.$$

Expanding along R_3 , we have

$$\begin{aligned} \Delta &= (\sin y - \cos y) (\cos^2 x + \sin^2 x) \\ &= (\sin y - \cos y) = \sqrt{2} \frac{1}{\sqrt{2}} \sin y - \frac{1}{\sqrt{2}} \cos y \\ &= \sqrt{2} \cos \frac{\pi}{4} \sin y - \sin \frac{\pi}{4} \cos y = \sqrt{2} \sin \left(y - \frac{\pi}{4} \right) \end{aligned}$$

Hence $-\sqrt{2} \leq \Delta \leq \sqrt{2}$.

Fill in the blanks in each of the Examples 12 to 14.

Example 12 If A, B, C are the angles of a triangle, then

$$\begin{vmatrix} \sin^2 A & \cot A & 1 \\ \sin^2 B & \cot B & 1 \\ \sin^2 C & \cot C & 1 \end{vmatrix} \dots\dots\dots$$

Solution Answer is 0. Apply $R_2 \rightarrow R_2 - R_1, R_3 \rightarrow R_3 - R_1$.

Example 13 The determinant $\Delta = \begin{vmatrix} \sqrt{23} + \sqrt{3} & \sqrt{5} & \sqrt{5} \\ \sqrt{15} + \sqrt{46} & 5 & \sqrt{10} \\ 3 + \sqrt{115} & \sqrt{15} & 5 \end{vmatrix}$ is equal to

Solution Answer is 0. Taking $\sqrt{5}$ common from C_2 and C_3 and applying $C_1 \rightarrow C_3 - \sqrt{3} C_2$, we get the desired result.

Example 14 The value of the determinant

$$\begin{vmatrix} \sin^2 23 & \sin^2 67 & \cos 180 \\ \sin^2 67 & \sin^2 23 & \cos^2 180 \\ \cos 180 & \sin^2 23 & \sin^2 67 \end{vmatrix} \dots\dots\dots$$

Solution $\Delta = 0$. Apply $C_1 \rightarrow C_1 + C_2 + C_3$.

State whether the statements in the Examples 15 to 18 is **True** or **False**.

Example 15 The determinant

$$\begin{vmatrix} \cos(x+y) & \sin(x+y) & \cos 2y \\ \sin x & \cos x & \sin y \\ \cos x & \sin x & \cos y \end{vmatrix}$$

is independent of x only.

Solution True. Apply $R_1 \rightarrow R_1 + \sin y R_2 + \cos y R_3$, and expand

Example 16 The value of

$$\begin{vmatrix} 1 & 1 & 1 \\ {}^n C_1 & {}^{n+2} C_1 & {}^{n+4} C_1 \\ {}^n C_2 & {}^{n+2} C_2 & {}^{n+4} C_2 \end{vmatrix} \text{ is } 8.$$

Solution True

Example 17 If $A = \begin{vmatrix} x & 5 & 2 \\ 2 & y & 3 \\ 1 & 1 & z \end{vmatrix}$, $xyz = 80$, $3x + 2y + 10z = 20$, then

$$A \text{ adj. } A = \begin{vmatrix} 81 & 0 & 0 \\ 0 & 81 & 0 \\ 0 & 0 & 81 \end{vmatrix}.$$

Solution : False.

Example 18 If $A = \begin{pmatrix} 0 & 1 & 3 \\ 1 & 2 & x \\ 2 & 3 & 1 \end{pmatrix}$, $A^{-1} = \begin{pmatrix} \frac{1}{2} & 4 & \frac{5}{2} \\ \frac{1}{2} & 3 & \frac{3}{2} \\ \frac{1}{2} & y & \frac{1}{2} \end{pmatrix}$

then $x = 1$, $y = -1$.

Solution True

4.3 EXERCISE

Short Answer (S.A.)

Using the properties of determinants in Exercises 1 to 6, evaluate:

1. $\begin{vmatrix} x^2 & x & 1 & x & 1 \\ x & 1 & x & 1 & \end{vmatrix}$

2. $\begin{vmatrix} a & x & y & z \\ x & a & y & z \\ x & y & a & z \end{vmatrix}$

3. $\begin{vmatrix} 0 & xy^2 & xz^2 \\ x^2y & 0 & yz^2 \\ x^2z & zy^2 & 0 \end{vmatrix}$

4. $\begin{vmatrix} 3x & x & y & x & z \\ x & y & 3y & z & y \\ x & z & y & z & 3z \end{vmatrix}$

5. $\begin{vmatrix} x & 4 & x & x \\ x & x & 4 & x \\ x & x & x & 4 \end{vmatrix}$

6. $\begin{vmatrix} a & b & c & 2a & 2a \\ 2b & b & c & a & 2b \\ 2c & 2c & c & a & b \end{vmatrix}$

Using the properties of determinants in Exercises 7 to 9, prove that:

7. $\begin{vmatrix} y^2z^2 & yz & y & z \\ z^2x^2 & zx & z & x \\ x^2y^2 & xy & x & y \end{vmatrix} = 0$

8. $\begin{vmatrix} y & z & z & y \\ z & z & x & x \\ y & x & x & y \end{vmatrix} = 4xyz$

9.
$$\begin{vmatrix} a^2 & 2a & 2a & 1 & 1 \\ 2a & 1 & a & 2 & 1 \\ 3 & & 3 & & 1 \end{vmatrix} (a-1)^3$$

10. If $A + B + C = 0$, then prove that
$$\begin{vmatrix} 1 & \cos C & \cos B \\ \cos C & 1 & \cos A \\ \cos B & \cos A & 1 \end{vmatrix} = 0$$

11. If the co-ordinates of the vertices of an equilateral triangle with sides of length

' a ' are $(x_1, y_1), (x_2, y_2), (x_3, y_3)$, then
$$\begin{vmatrix} x_1 & y_1 & 1 \\ x_2 & y_2 & 1 \\ x_3 & y_3 & 1 \end{vmatrix}^2 = \frac{3a^4}{4}.$$

12. Find the value of θ satisfying
$$\begin{bmatrix} 1 & 1 & \sin 3\theta \\ -4 & 3 & \cos 2\theta \\ 7 & -7 & -2 \end{bmatrix} = 0.$$

13. If
$$\begin{vmatrix} 4 & x & 4 & x & 4 & x \\ 4 & x & 4 & x & 4 & x \\ 4 & x & 4 & x & 4 & x \end{vmatrix} = 0,$$
 then find values of x .

14. If $a_1, a_2, a_3, \dots, a_r$ are in G.P., then prove that the determinant

$$\begin{vmatrix} a_{r-1} & a_{r-5} & a_{r-9} \\ a_{r-7} & a_{r-11} & a_{r-15} \\ a_{r-11} & a_{r-17} & a_{r-21} \end{vmatrix}$$
 is independent of r .

15. Show that the points $(a+5, a-4), (a-2, a+3)$ and (a, a) do not lie on a straight line for any value of a .

16. Show that the $\triangle ABC$ is an isosceles triangle if the determinant

$$\Delta = \begin{vmatrix} 1 & 1 & 1 \\ 1 + \cos A & 1 + \cos B & 1 + \cos C \\ \cos^2 A + \cos A & \cos^2 B + \cos B & \cos^2 C + \cos C \end{vmatrix} = 0.$$

17. Find A^{-1} if $A = \begin{vmatrix} 0 & 1 & 1 \\ 1 & 0 & 1 \\ 1 & 1 & 0 \end{vmatrix}$ and show that $A^{-1} = \frac{A^2 - 3I}{2}$.

Long Answer (L.A.)

18. If $A = \begin{bmatrix} 1 & 2 & 0 \\ -2 & -1 & -2 \\ 0 & -1 & 1 \end{bmatrix}$, find A^{-1} .

Using A^{-1} , solve the system of linear equations $x - 2y = 10$, $2x - y - z = 8$, $-2y + z = 7$.

19. Using matrix method, solve the system of equations $3x + 2y - 2z = 3$, $x + 2y + 3z = 6$, $2x - y + z = 2$.

20. Given $A = \begin{vmatrix} 2 & 2 & 4 \\ 4 & 2 & 4 \\ 2 & 1 & 5 \end{vmatrix}$, $B = \begin{vmatrix} 1 & 1 & 0 \\ 2 & 3 & 4 \\ 0 & 1 & 2 \end{vmatrix}$, find BA and use this to solve the

system of equations $y + 2z = 7$, $x - y = 3$, $2x + 3y + 4z = 17$.

21. If $a + b + c \neq 0$ and $\begin{vmatrix} a & b & c \\ b & c & a \\ c & a & b \end{vmatrix} = 0$, then prove that $a = b = c$.

22. Prove that $\begin{vmatrix} bc & a^2 & ca & b^2 & ab & c^2 \\ ca & b^2 & ab & c^2 & bc & a^2 \\ ab & c^2 & bc & a^2 & ca & b^2 \end{vmatrix}$ is divisible by $a + b + c$ and find the

quotient.

23. If $x + y + z = 0$, prove that
$$\begin{vmatrix} xa & yb & zc \\ yc & za & xb \\ zb & xc & ya \end{vmatrix} = xyz \begin{vmatrix} a & b & c \\ c & a & b \\ b & c & a \end{vmatrix}$$

Objective Type Questions (M.C.Q.)

Choose the correct answer from given four options in each of the Exercises from 24 to 37.

24. If $\begin{vmatrix} 2x & 5 \\ 8 & x \end{vmatrix} = \begin{vmatrix} 6 & 2 \\ 7 & 3 \end{vmatrix}$, then value of x is

- (A) 3 (B) ± 3
(C) ± 6 (D) 6

25. The value of determinant
$$\begin{vmatrix} a-b & b+c & a \\ b-a & c+a & b \\ c-a & a+b & c \end{vmatrix}$$

- (A) $a^3 + b^3 + c^3$ (B) $3bc$
(C) $a^3 + b^3 + c^3 - 3abc$ (D) none of these

26. The area of a triangle with vertices $(-3, 0)$, $(3, 0)$ and $(0, k)$ is 9 sq. units. The value of k will be

- (A) 9 (B) 3
(C) -9 (D) 6

27. The determinant
$$\begin{vmatrix} b^2 & ab & b & c & bc & ac \\ ab & a^2 & a & b & b^2 & ab \\ bc & ac & c & a & ab & a^2 \end{vmatrix}$$
 equals

- (A) $abc(b-c)(c-a)(a-b)$ (B) $(b-c)(c-a)(a-b)$
(C) $(a+b+c)(b-c)(c-a)(a-b)$ (D) None of these

28. The number of distinct real roots of $\begin{vmatrix} \sin x & \cos x & \cos x \\ \cos x & \sin x & \cos x \\ \cos x & \cos x & \sin x \end{vmatrix} = 0$ in the interval

$$-\frac{\pi}{4} \leq x \leq \frac{\pi}{4} \text{ is}$$

- (A) 0 (B) 2
(C) 1 (D) 3
29. If A, B and C are angles of a triangle, then the determinant

$$\begin{vmatrix} 1 & \cos C & \cos B \\ \cos C & 1 & \cos A \\ \cos B & \cos A & 1 \end{vmatrix} \text{ is equal to}$$

- (A) 0 (B) -1
(C) 1 (D) None of these
30. Let $f(t) = \begin{vmatrix} \cos t & t & 1 \\ 2\sin t & t & 2t \\ \sin t & t & t \end{vmatrix}$, then $\lim_{t \rightarrow 0} \frac{f(t)}{t^2}$ is equal to

- (A) 0 (B) -1
(C) 2 (D) 3

31. The maximum value of $\begin{vmatrix} 1 & 1 & 1 \\ 1 & 1 & \sin \theta \\ 1 & \cos \theta & 1 \end{vmatrix}$ is (θ is real number)

- (A) $\frac{1}{2}$ (B) $\frac{\sqrt{3}}{2}$
(C) $\sqrt{2}$ (D) $\frac{2\sqrt{3}}{4}$

32. If $f(x) = \begin{vmatrix} 0 & x & a & x & b \\ x & a & 0 & x & c \\ x & b & x & c & 0 \end{vmatrix}$, then

- (A) $f(a) = 0$ (B) $f(b) = 0$
 (C) $f(0) = 0$ (D) $f(1) = 0$

33. If $A = \begin{vmatrix} & 2 & & 3 \\ 0 & 2 & 5 & \\ & 1 & 1 & 3 \end{vmatrix}$, then A^{-1} exists if

- (A) $\lambda = 2$ (B) $\lambda \neq 2$
 (C) $\lambda \neq -2$ (D) None of these

34. If A and B are invertible matrices, then which of the following is not correct?

- (A) $\text{adj } A = |A| \cdot A^{-1}$ (B) $\det(A)^{-1} = [\det(A)]^{-1}$
 (C) $(AB)^{-1} = B^{-1} A^{-1}$ (D) $(A + B)^{-1} = B^{-1} + A^{-1}$

35. If x, y, z are all different from zero and $\begin{vmatrix} 1 & x & 1 & 1 \\ 1 & 1 & y & 1 \\ 1 & 1 & 1 & z \end{vmatrix} = 0$, then value of

$x^{-1} + y^{-1} + z^{-1}$ is

- (A) $x y z$ (B) $x^{-1} y^{-1} z^{-1}$
 (C) $-x - y - z$ (D) -1

36. The value of the determinant $\begin{vmatrix} x & x & y & x & 2y \\ x & 2y & x & x & y \\ x & y & x & 2y & x \end{vmatrix}$ is

- (A) $9x^2(x + y)$ (B) $9y^2(x + y)$
 (C) $3y^2(x + y)$ (D) $7x^2(x + y)$

37. There are two values of a which makes determinant, $\Delta = \begin{vmatrix} 1 & -2 & 5 \\ 2 & a & 1 \\ 0 & 4 & 2a \end{vmatrix} = 86$, then

sum of these number is

- (A) 4 (B) 5
(C) -4 (D) 9

Fill in the blanks

38. If A is a matrix of order 3×3 , then $|3A| = \underline{\hspace{2cm}}$.

39. If A is invertible matrix of order 3×3 , then $|A^{-1}| \underline{\hspace{2cm}}$.

40. If $x, y, z \in \mathbb{R}$, then the value of determinant $\begin{vmatrix} 2^x & 2^{-x} & 2^x & 2^{-x} & 1 \\ 3^x & 3^{-x} & 3^x & 3^{-x} & 1 \\ 4^x & 4^{-x} & 4^x & 4^{-x} & 1 \end{vmatrix}$ is

equal to $\underline{\hspace{2cm}}$.

41. If $\cos 2\theta = 0$, then $\begin{vmatrix} 0 & \cos \theta & \sin \theta \\ \cos \theta & \sin \theta & 0 \\ \sin \theta & 0 & \cos \theta \end{vmatrix}^2 = \underline{\hspace{2cm}}$.

42. If A is a matrix of order 3×3 , then $(A^2)^{-1} = \underline{\hspace{2cm}}$.

43. If A is a matrix of order 3×3 , then number of minors in determinant of A are $\underline{\hspace{2cm}}$.

44. The sum of the products of elements of any row with the co-factors of corresponding elements is equal to $\underline{\hspace{2cm}}$.

45. If $x = -9$ is a root of $\begin{vmatrix} x & 3 & 7 \\ 2 & x & 2 \\ 7 & 6 & x \end{vmatrix} = 0$, then other two roots are $\underline{\hspace{2cm}}$.

46. $\begin{vmatrix} 0 & xyz & x-z \\ y-x & 0 & y-z \\ z-x & z-y & 0 \end{vmatrix} = \underline{\hspace{2cm}}$.

47. If $f(x) = \begin{vmatrix} (1+x)^{17} & (1+x)^{19} & (1+x)^{23} \\ (1+x)^{23} & (1+x)^{29} & (1+x)^{34} \\ (1+x)^{41} & (1+x)^{43} & (1+x)^{47} \end{vmatrix} = A + Bx + Cx^2 + \dots$, then

A = _____.

State True or False for the statements of the following Exercises:

48. $A^3^{-1} = A^{-1}{}^3$, where A is a square matrix and $|A| \neq 0$.

49. $(aA)^{-1} = \frac{1}{a}A^{-1}$, where a is any real number and A is a square matrix.

50. $|A^{-1}| \neq |A|^{-1}$, where A is non-singular matrix.

51. If A and B are matrices of order 3 and $|A| = 5$, $|B| = 3$, then $|3AB| = 27 \times 5 \times 3 = 405$.

52. If the value of a third order determinant is 12, then the value of the determinant formed by replacing each element by its co-factor will be 144.

53. $\begin{vmatrix} x+1 & x+2 & x+a \\ x+2 & x+3 & x+b \\ x+3 & x+4 & x+c \end{vmatrix} = 0$, where a, b, c are in A.P.

54. $|\text{adj. } A| = |A|^2$, where A is a square matrix of order two.

55. The determinant $\begin{vmatrix} \sin A & \cos A & \sin A + \cos B \\ \sin B & \cos A & \sin B + \cos B \\ \sin C & \cos A & \sin C + \cos B \end{vmatrix}$ is equal to zero.

56. If the determinant $\begin{vmatrix} x & a & p & u & l & f \\ y & b & q & v & m & g \\ z & c & r+w & n & h \end{vmatrix}$ splits into exactly K determinants of

order 3, each element of which contains only one term, then the value of K is 8.

57. Let $\begin{vmatrix} a & p & x \\ b & q & y \\ c & r & z \end{vmatrix} = 16$, then $\Delta_1 = \begin{vmatrix} p+x & a+x & a+p \\ q+y & b+y & b+q \\ r+z & c+z & c+r \end{vmatrix} = 32$.

58. The maximum value of $\begin{vmatrix} 1 & 1 & 1 \\ 1 & (1 \sin \theta) & 1 \\ 1 & 1 & 1 \cos \theta \end{vmatrix}$ is $\frac{1}{2}$.



CONTINUITY AND DIFFERENTIABILITY

5.1 Overview

5.1.1 Continuity of a function at a point

Let f be a real function on a subset of the real numbers and let c be a point in the domain of f . Then f is continuous at c if

$$\lim_{x \rightarrow c} f(x) = f(c)$$

More elaborately, if the left hand limit, right hand limit and the value of the function at $x = c$ exist and are equal to each other, i.e.,

$$\lim_{x \rightarrow c^-} f(x) = f(c) = \lim_{x \rightarrow c^+} f(x)$$

then f is said to be continuous at $x = c$.

5.1.2 Continuity in an interval

(i) f is said to be continuous in an open interval (a, b) if it is continuous at every point in this interval.

(ii) f is said to be continuous in the closed interval $[a, b]$ if

- f is continuous in (a, b)

- $\lim_{x \rightarrow a^+} f(x) = f(a)$

- $\lim_{x \rightarrow b^-} f(x) = f(b)$

5.1.3 Geometrical meaning of continuity

- (i) Function f will be continuous at $x = c$ if there is no break in the graph of the function at the point $(c, f(c))$.
- (ii) In an interval, function is said to be continuous if there is no break in the graph of the function in the entire interval.

5.1.4 Discontinuity

The function f will be discontinuous at $x = a$ in any of the following cases :

- (i) $\lim_{x \rightarrow a^-} f(x)$ and $\lim_{x \rightarrow a^+} f(x)$ exist but are not equal.
- (ii) $\lim_{x \rightarrow a^-} f(x)$ and $\lim_{x \rightarrow a^+} f(x)$ exist and are equal but not equal to $f(a)$.
- (iii) $f(a)$ is not defined.

5.1.5 Continuity of some of the common functions

Function $f(x)$	Interval in which f is continuous
1. The constant function, i.e. $f(x) = c$	R
2. The identity function, i.e. $f(x) = x$	
3. The polynomial function, i.e. $f(x) = a_0 x^n + a_1 x^{n-1} + \dots + a_{n-1} x + a_n$	
4. $ x - a $	$(-\infty, \infty)$
5. x^n , n is a positive integer	$(-\infty, \infty) - \{0\}$
6. $p(x) / q(x)$, where $p(x)$ and $q(x)$ are polynomials in x	R - $\{x : q(x) = 0\}$
7. $\sin x, \cos x$	R
8. $\tan x, \sec x$	R - $\{(2n + 1) \frac{\pi}{2} : n \in \mathbf{Z}\}$
9. $\cot x, \operatorname{cosec} x$	R - $\{n\pi : n \in \mathbf{Z}\}$

- | | |
|--|--------------------------------|
| 10. e^x | R |
| 11. $\log x$ | $(0, \infty)$ |
| 12. The inverse trigonometric functions,
i.e., $\sin^{-1} x$, $\cos^{-1} x$ etc. | In their respective
domains |

5.1.6 Continuity of composite functions

Let f and g be real valued functions such that $(f \circ g)$ is defined at a . If g is continuous at a and f is continuous at $g(a)$, then $(f \circ g)$ is continuous at a .

5.1.7 Differentiability

The function defined by $f'(x) = \lim_{h \rightarrow 0} \frac{f(x+h) - f(x)}{h}$, wherever the limit exists, is defined to be the derivative of f at x . In other words, we say that a function f is differentiable at a point c in its domain if both $\lim_{h \rightarrow 0^-} \frac{f(c+h) - f(c)}{h}$, called left hand derivative, denoted by $Lf'(c)$, and $\lim_{h \rightarrow 0^+} \frac{f(c+h) - f(c)}{h}$, called right hand derivative, denoted by $Rf'(c)$, are finite and equal.

- (i) The function $y = f(x)$ is said to be differentiable in an open interval (a, b) if it is differentiable at every point of (a, b)
- (ii) The function $y = f(x)$ is said to be differentiable in the closed interval $[a, b]$ if $Rf'(a)$ and $Lf'(b)$ exist and $f'(x)$ exists for every point of (a, b) .
- (iii) Every differentiable function is continuous, but the converse is not true

5.1.8 Algebra of derivatives

If u, v are functions of x , then

$$(i) \quad \frac{d(u \pm v)}{dx} = \frac{du}{dx} \pm \frac{dv}{dx} \qquad (ii) \quad \frac{d}{dx}(uv) = u \frac{dv}{dx} + v \frac{du}{dx}$$

$$(iii) \quad \frac{d}{dx} \left(\frac{u}{v} \right) = \frac{v \frac{du}{dx} - u \frac{dv}{dx}}{v^2}$$

5.1.9 Chain rule is a rule to differentiate composition of functions. Let $f = v \circ u$. If

$$t = u(x) \text{ and both } \frac{dt}{dx} \text{ and } \frac{dv}{dt} \text{ exist then } \frac{df}{dx} = \frac{dv}{dt} \cdot \frac{dt}{dx}$$

5.1.10 Following are some of the standard derivatives (in appropriate domains)

$$1. \frac{d}{dx}(\sin^{-1} x) = \frac{1}{\sqrt{1-x^2}} \quad 2. \frac{d}{dx}(\cos^{-1} x) = \frac{-1}{\sqrt{1-x^2}}$$

$$3. \frac{d}{dx}(\tan^{-1} x) = \frac{1}{1+x^2} \quad 4. \frac{d}{dx}(\cot^{-1} x) = \frac{-1}{1+x^2}$$

$$5. \frac{d}{dx}(\sec^{-1} x) = \frac{1}{|x|\sqrt{x^2-1}}, |x| > 1$$

$$6. \frac{d}{dx}(\operatorname{cosec}^{-1} x) = \frac{-1}{|x|\sqrt{x^2-1}}, |x| > 1$$

5.1.11 Exponential and logarithmic functions

- (i) The exponential function with positive base $b > 1$ is the function $y = f(x) = b^x$. Its domain is \mathbf{R} , the set of all real numbers and range is the set of all positive real numbers. Exponential function with base 10 is called the common exponential function and with base e is called the natural exponential function.
- (ii) Let $b > 1$ be a real number. Then we say logarithm of a to base b is x if $b^x = a$. Logarithm of a to the base b is denoted by $\log_b a$. If the base $b = 10$, we say it is common logarithm and if $b = e$, then we say it is natural logarithms. $\log x$ denotes the logarithm function to base e . The domain of logarithm function is \mathbf{R}^+ , the set of all positive real numbers and the range is the set of all real numbers.
- (iii) The properties of logarithmic function to any base $b > 1$ are listed below:

$$1. \log_b(xy) = \log_b x + \log_b y$$

$$2. \log_b \left(\frac{x}{y} \right) = \log_b x - \log_b y$$

$$3. \log_b x^n = n \log_b x$$

$$4. \log_b x = \frac{\log_c x}{\log_c b}, \text{ where } c > 1$$

$$5. \log_b x = \frac{1}{\log_x b}$$

$$6. \log_b b = 1 \text{ and } \log_b 1 = 0$$

(iv) The derivative of e^x w.r.t., x is e^x , i.e. $\frac{d}{dx}(e^x) = e^x$. The derivative of $\log x$

$$\text{w.r.t., } x \text{ is } \frac{1}{x}; \text{ i.e. } \frac{d}{dx}(\log x) = \frac{1}{x}.$$

5.1.12 Logarithmic differentiation is a powerful technique to differentiate functions of the form $f(x) = (u(x))^{v(x)}$, where both f and u need to be positive functions for this technique to make sense.

5.1.13 Differentiation of a function with respect to another function

Let $u = f(x)$ and $v = g(x)$ be two functions of x , then to find derivative of $f(x)$ w.r.t.

to $g(x)$, i.e., to find $\frac{du}{dv}$, we use the formula

$$\frac{du}{dv} = \frac{\frac{du}{dx}}{\frac{dv}{dx}}$$

5.1.14 *Second order derivative*

$\frac{d}{dx} \frac{dy}{dx} = \frac{d^2y}{dx^2}$ is called the second order derivative of y w.r.t. x . It is denoted by y'' or y_2 , if $y = f(x)$.

5.1.15 *Rolle's Theorem*

Let $f: [a, b] \rightarrow \mathbf{R}$ be continuous on $[a, b]$ and differentiable on (a, b) , such that $f(a) = f(b)$, where a and b are some real numbers. Then there exists at least one point c in (a, b) such that $f'(c) = 0$.

Geometrically Rolle's theorem ensures that there is at least one point on the curve $y = f(x)$ at which tangent is parallel to x -axis (abscissa of the point lying in (a, b)).

5.1.16 Mean Value Theorem (Lagrange)

Let $f: [a, b] \rightarrow \mathbf{R}$ be a continuous function on $[a, b]$ and differentiable on (a, b) . Then

there exists at least one point c in (a, b) such that $f'(c) = \frac{f(b) - f(a)}{b - a}$.

Geometrically, Mean Value Theorem states that there exists at least one point c in (a, b) such that the tangent at the point $(c, f(c))$ is parallel to the secant joining the points $(a, f(a))$ and $(b, f(b))$.

5.2 Solved Examples

Short Answer (S.A.)

Example 1 Find the value of the constant k so that the function f defined below is

continuous at $x = 0$, where $f(x) = \begin{cases} \frac{1 - \cos 4x}{8x^2}, & x \neq 0 \\ k, & x = 0 \end{cases}$.

Solution It is given that the function f is continuous at $x = 0$. Therefore, $\lim_{x \rightarrow 0} f(x) = f(0)$

$$\Rightarrow \lim_{x \rightarrow 0} \frac{1 - \cos 4x}{8x^2} = k$$

$$\Rightarrow \lim_{x \rightarrow 0} \frac{2 \sin^2 2x}{8x^2} = k$$

$$\Rightarrow \lim_{x \rightarrow 0} \left(\frac{\sin 2x}{2x} \right)^2 = k$$

$$\Rightarrow k = 1$$

Thus, f is continuous at $x = 0$ if $k = 1$.

Example 2 Discuss the continuity of the function $f(x) = \sin x \cdot \cos x$.

Solution Since $\sin x$ and $\cos x$ are continuous functions and product of two continuous function is a continuous function, therefore $f(x) = \sin x \cdot \cos x$ is a continuous function.

Example 3 If $f(x) = \begin{cases} \frac{x^3 + x^2 - 16x + 20}{(x-2)^2}, & x \neq 2 \\ k, & x = 2 \end{cases}$ is continuous at $x = 2$, find

the value of k .

Solution Given $f(2) = k$.

$$\begin{aligned} \text{Now, } \lim_{x \rightarrow 2^-} f(x) &= \lim_{x \rightarrow 2^+} f(x) = \lim_{x \rightarrow 2} \frac{x^3 + x^2 - 16x + 20}{(x-2)^2} \\ &= \lim_{x \rightarrow 2} \frac{(x-5)(x-2)^2}{(x-2)^2} = \lim_{x \rightarrow 2} (x-5) = 7 \end{aligned}$$

As f is continuous at $x = 2$, we have

$$\begin{aligned} \lim_{x \rightarrow 2} f(x) &= f(2) \\ \Rightarrow k &= 7. \end{aligned}$$

Example 4 Show that the function f defined by

$$f(x) = \begin{cases} x \sin \frac{1}{x}, & x \neq 0 \\ 0, & x = 0 \end{cases}$$

is continuous at $x = 0$.

Solution Left hand limit at $x = 0$ is given by

$$\lim_{x \rightarrow 0^-} f(x) = \lim_{x \rightarrow 0^-} x \sin \frac{1}{x} = 0 \quad \left[\text{since, } -1 < \sin \frac{1}{x} < 1 \right]$$

Similarly $\lim_{x \rightarrow 0^+} f(x) = \lim_{x \rightarrow 0^+} x \sin \frac{1}{x} = 0$. Moreover $f(0) = 0$.

Thus $\lim_{x \rightarrow 0^-} f(x) = \lim_{x \rightarrow 0^+} f(x) = f(0)$. Hence f is continuous at $x = 0$.

Example 5 Given $f(x) = \frac{1}{x-1}$. Find the points of discontinuity of the composite function $y = f[f(x)]$.

Solution We know that $f(x) = \frac{1}{x-1}$ is discontinuous at $x = 1$

Now, for $x = 1$,

$$f(f(x)) = f\left(\frac{1}{x-1}\right) = \frac{1}{\frac{1}{x-1}-1} = \frac{x-1}{2-x},$$

which is discontinuous at $x = 2$.

Hence, the points of discontinuity are $x = 1$ and $x = 2$.

Example 6 Let $f(x) = x|x|$, for all $x \in \mathbf{R}$. Discuss the derivability of $f(x)$ at $x = 0$

Solution We may rewrite f as $f(x) = \begin{cases} x^2, & \text{if } x \geq 0 \\ -x^2, & \text{if } x < 0 \end{cases}$

$$\text{Now } Lf'(0) = \lim_{h \rightarrow 0^-} \frac{f(0+h) - f(0)}{h} = \lim_{h \rightarrow 0^-} \frac{-h^2 - 0}{h} = \lim_{h \rightarrow 0^-} -h = 0$$

$$\text{Now } Rf'(0) = \lim_{h \rightarrow 0^+} \frac{f(0+h) - f(0)}{h} = \lim_{h \rightarrow 0^+} \frac{h^2 - 0}{h} = \lim_{h \rightarrow 0^+} h = 0$$

Since the left hand derivative and right hand derivative both are equal, hence f is differentiable at $x = 0$.

Example 7 Differentiate $\sqrt{\tan \sqrt{x}}$ w.r.t. x

Solution Let $y = \sqrt{\tan \sqrt{x}}$. Using chain rule, we have

$$\begin{aligned} \frac{dy}{dx} &= \frac{1}{2\sqrt{\tan \sqrt{x}}} \cdot \frac{d}{dx}(\tan \sqrt{x}) \\ &= \frac{1}{2\sqrt{\tan \sqrt{x}}} \cdot \sec^2 \sqrt{x} \cdot \frac{d}{dx}(\sqrt{x}) \\ &= \frac{1}{2\sqrt{\tan \sqrt{x}}} (\sec^2 \sqrt{x}) \cdot \frac{1}{2\sqrt{x}} \\ &= \frac{(\sec^2 \sqrt{x})}{4\sqrt{x}\sqrt{\tan \sqrt{x}}} \end{aligned}$$

Example 8 If $y = \tan(x+y)$, find $\frac{dy}{dx}$.

Solution Given $y = \tan(x+y)$. Differentiating both sides w.r.t. x , we have

$$\begin{aligned}\frac{dy}{dx} \sec^2(x+y) \frac{d}{dx}(x+y) \\ = \sec^2(x+y) \cdot 1 \frac{dy}{dx}\end{aligned}$$

or $[1 - \sec^2(x+y)] \frac{dy}{dx} = \sec^2(x+y)$

Therefore, $\frac{dy}{dx} \frac{\sec^2(x+y)}{1 - \sec^2(x+y)} = -\operatorname{cosec}^2(x+y)$.

Example 9 If $e^x + e^y = e^{x+y}$, prove that

$$\frac{dy}{dx} = -e^{y-x}$$

Solution Given that $e^x + e^y = e^{x+y}$. Differentiating both sides w.r.t. x , we have

$$e^x + e^y \frac{dy}{dx} = e^{x+y} \cdot 1 \frac{dy}{dx}$$

or $(e^y - e^{x+y}) \frac{dy}{dx} = e^{x+y} - e^x$,

which implies that $\frac{dy}{dx} = \frac{e^x - e^{x+y}}{e^y - e^{x+y}} = \frac{e^x}{e^y} \frac{e^y - e^x}{e^x - e^y} = -e^{y-x}$.

Example 10 Find $\frac{dy}{dx}$, if $y = \tan^{-1} \left(\frac{3x-x^3}{1-3x^2} \right)$, $-\frac{1}{\sqrt{3}} < x < \frac{1}{\sqrt{3}}$.

Solution Put $x = \tan \theta$, where $-\frac{\pi}{6} < \theta < \frac{\pi}{6}$.

$$\begin{aligned}\text{Therefore, } y &= \tan^{-1} \left(\frac{3 \tan \theta - \tan^3 \theta}{1 - 3 \tan^2 \theta} \right) \\ &= \tan^{-1} (\tan 3\theta) \\ &= 3\theta \quad \left(\text{because } \frac{-\pi}{2} < 3\theta < \frac{\pi}{2} \right) \\ &= 3 \tan^{-1} x\end{aligned}$$

Hence,
$$\frac{dy}{dx} = \frac{3}{1-x^2}.$$

Example 11 If $y = \sin^{-1} x \sqrt{1-x} - \sqrt{x} \sqrt{1-x^2}$ and $0 < x < 1$, then find $\frac{dy}{dx}$.

Solution We have $y = \sin^{-1} x \sqrt{1-x} - \sqrt{x} \sqrt{1-x^2}$, where $0 < x < 1$.

Put $x = \sin A$ and $\sqrt{x} = \sin B$

Therefore,
$$\begin{aligned} y &= \sin^{-1} \sin A \sqrt{1-\sin^2 B} - \sin B \sqrt{1-\sin^2 A} \\ &= \sin^{-1} \sin A \cos B - \sin B \cos A \\ &= \sin^{-1} \sin(A-B) = A-B \end{aligned}$$

Thus $y = \sin^{-1} x - \sin^{-1} \sqrt{x}$

Differentiating w.r.t. x , we get

$$\begin{aligned} \frac{dy}{dx} &= \frac{1}{\sqrt{1-x^2}} - \frac{1}{\sqrt{1-\sqrt{x}^2}} \cdot \frac{d}{dx} \sqrt{x} \\ &= \frac{1}{\sqrt{1-x^2}} - \frac{1}{2\sqrt{x} \sqrt{1-x}}. \end{aligned}$$

Example 12 If $x = a \sec^3 \theta$ and $y = a \tan^3 \theta$, find $\frac{dy}{dx}$ at $\frac{\pi}{3}$.

Solution We have $x = a \sec^3 \theta$ and $y = a \tan^3 \theta$.

Differentiating w.r.t. θ , we get

$$\begin{aligned} \frac{dx}{d\theta} &= 3a \sec^2 \theta \frac{d}{d\theta}(\sec \theta) = 3a \sec^3 \theta \tan \theta \\ \text{and } \frac{dy}{d\theta} &= 3a \tan^2 \theta \frac{d}{d\theta}(\tan \theta) = 3a \tan^2 \theta \sec^2 \theta. \end{aligned}$$

Thus
$$\frac{dy}{dx} = \frac{\frac{dy}{d\theta}}{\frac{dx}{d\theta}} = \frac{3a \tan^2 \theta \sec^2 \theta}{3a \sec^3 \theta \tan \theta} = \frac{\tan \theta}{\sec \theta} = \sin \theta.$$

Hence, $\frac{dy}{dx}$ at $\frac{\pi}{3} = \sin \frac{\pi}{3} = \frac{\sqrt{3}}{2}$.

Example 13 If $x^y = e^{x-y}$, prove that $\frac{dy}{dx} = \frac{\log x}{(1 - \log x)^2}$.

Solution We have $x^y = e^{x-y}$. Taking logarithm on both sides, we get

$$\begin{aligned} y \log x &= x - y \\ \Rightarrow y(1 + \log x) &= x \end{aligned}$$

i.e. $y = \frac{x}{1 + \log x}$

Differentiating both sides w.r.t. x , we get

$$\frac{dy}{dx} = \frac{(1 + \log x) \cdot 1 - x \cdot \frac{1}{x}}{(1 + \log x)^2} = \frac{\log x}{(1 + \log x)^2}.$$

Example 14 If $y = \tan x + \sec x$, prove that $\frac{d^2 y}{dx^2} = \frac{\cos x}{(1 - \sin x)^2}$.

Solution We have $y = \tan x + \sec x$. Differentiating w.r.t. x , we get

$$\begin{aligned} \frac{dy}{dx} &= \sec^2 x + \sec x \tan x \\ &= \frac{1}{\cos^2 x} + \frac{\sin x}{\cos^2 x} = \frac{1 + \sin x}{\cos^2 x} = \frac{1 + \sin x}{(1 + \sin x)(1 - \sin x)}. \end{aligned}$$

thus $\frac{dy}{dx} = \frac{1}{1 - \sin x}$.

Now, differentiating again w.r.t. x , we get

$$\frac{d^2 y}{dx^2} = \frac{-(-\cos x)}{(1 - \sin x)^2} = \frac{\cos x}{(1 - \sin x)^2}$$

Example 15 If $f(x) = |\cos x|$, find $f' \left(\frac{3\pi}{4} \right)$.

Solution When $\frac{\pi}{2} < x < \pi$, $\cos x < 0$ so that $|\cos x| = -\cos x$, i.e., $f(x) = -\cos x$
 $f'(x) = \sin x$.

$$\text{Hence, } f' \left(\frac{3}{4} \right) = \sin \left(\frac{3}{4} \right) = \frac{1}{\sqrt{2}}$$

Example 16 If $f(x) = |\cos x - \sin x|$, find $f' \left(\frac{\pi}{6} \right)$.

Solution When $0 < x < \frac{\pi}{4}$, $\cos x > \sin x$, so that $\cos x - \sin x > 0$, i.e.,

$$f(x) = \cos x - \sin x$$

$$f'(x) = -\sin x - \cos x$$

$$\text{Hence } f' \left(\frac{\pi}{6} \right) = -\sin \frac{\pi}{6} - \cos \frac{\pi}{6} = -\frac{1}{2}(1 + \sqrt{3}).$$

Example 17 Verify Rolle's theorem for the function, $f(x) = \sin 2x$ in $\left[0, \frac{\pi}{2} \right]$.

Solution Consider $f(x) = \sin 2x$ in $\left[0, \frac{\pi}{2} \right]$. Note that:

- (i) The function f is continuous in $\left[0, \frac{\pi}{2} \right]$, as f is a sine function, which is always continuous.
- (ii) $f'(x) = 2\cos 2x$, exists in $\left[0, \frac{\pi}{2} \right]$, hence f is derivable in $\left(0, \frac{\pi}{2} \right)$.
- (iii) $f(0) = \sin 0 = 0$ and $f \left(\frac{\pi}{2} \right) = \sin \pi = 0 \Rightarrow f(0) = f \left(\frac{\pi}{2} \right)$.

Conditions of Rolle's theorem are satisfied. Hence there exists at least one $c \in \left(0, \frac{\pi}{2} \right)$ such that $f'(c) = 0$. Thus

$$2 \cos 2c = 0 \quad \Rightarrow \quad 2c = \frac{\pi}{2} \quad \Rightarrow \quad c = \frac{\pi}{4}.$$

Example 18 Verify mean value theorem for the function $f(x) = (x - 3)(x - 6)(x - 9)$ in $[3, 5]$.

Solution (i) Function f is continuous in $[3, 5]$ as product of polynomial functions is a polynomial, which is continuous.

(ii) $f'(x) = 3x^2 - 36x + 99$ exists in $(3, 5)$ and hence derivable in $(3, 5)$.

Thus conditions of mean value theorem are satisfied. Hence, there exists at least one $c \in (3, 5)$ such that

$$\begin{aligned} f'(c) &= \frac{f(5) - f(3)}{5 - 3} \\ \Rightarrow 3c^2 - 36c + 99 &= \frac{8 - 0}{2} = 4 \\ \Rightarrow c &= 6 \pm \sqrt{\frac{13}{3}}. \end{aligned}$$

Hence $c = 6 - \sqrt{\frac{13}{3}}$ (since other value is not permissible).

Long Answer (L.A.)

Example 19 If $f(x) = \frac{\sqrt{2} \cos x - 1}{\cot x - 1}, x \neq \frac{\pi}{4}$

find the value of $f\left(\frac{\pi}{4}\right)$ so that $f(x)$ becomes continuous at $x = \frac{\pi}{4}$.

Solution Given, $f(x) = \frac{\sqrt{2} \cos x - 1}{\cot x - 1}, x \neq \frac{\pi}{4}$

$$\begin{aligned} \text{Therefore, } \lim_{x \rightarrow \frac{\pi}{4}} f(x) &= \lim_{x \rightarrow \frac{\pi}{4}} \frac{\sqrt{2} \cos x - 1}{\cot x - 1} \\ &= \lim_{x \rightarrow \frac{\pi}{4}} \frac{(\sqrt{2} \cos x - 1) \sin x}{\cos x - \sin x} \\ &= \lim_{x \rightarrow \frac{\pi}{4}} \frac{\sqrt{2} \cos x - 1}{\sqrt{2} \cos x - 1} \cdot \frac{\sqrt{2} \cos x - 1}{\cos x - \sin x} \cdot \frac{\cos x + \sin x}{\cos x + \sin x} \cdot \sin x \end{aligned}$$

$$\begin{aligned}
&= \lim_{x \rightarrow \frac{\pi}{4}} \frac{2 \cos^2 x - 1}{\cos^2 x - \sin^2 x} \cdot \frac{\cos x + \sin x}{\sqrt{2} \cos x + 1} \cdot (\sin x) \\
&= \lim_{x \rightarrow \frac{\pi}{4}} \frac{\cos 2x}{\cos 2x} \cdot \left(\frac{\cos x + \sin x}{\sqrt{2} \cos x + 1} \right) \cdot (\sin x) \\
&= \lim_{x \rightarrow \frac{\pi}{4}} \frac{\cos x + \sin x}{\sqrt{2} \cos x + 1} \sin x \\
&= \frac{\frac{1}{\sqrt{2}} + \frac{1}{\sqrt{2}}}{\sqrt{2} \cdot \frac{1}{\sqrt{2}} + 1} \cdot \frac{1}{2}
\end{aligned}$$

Thus, $\lim_{x \rightarrow \frac{\pi}{4}} f(x) = \frac{1}{2}$

If we define $f\left(\frac{\pi}{4}\right) = \frac{1}{2}$, then $f(x)$ will become continuous at $x = \frac{\pi}{4}$. Hence for f to be continuous at $x = \frac{\pi}{4}$, $f\left(\frac{\pi}{4}\right) = \frac{1}{2}$.

Example 20 Show that the function f given by $f(x) = \begin{cases} \frac{e^x - 1}{e^x + 1}, & \text{if } x < 0 \\ 0, & \text{if } x = 0 \\ \frac{e^x + 1}{e^x - 1}, & \text{if } x > 0 \end{cases}$

is discontinuous at $x = 0$.

Solution The left hand limit of f at $x = 0$ is given by

$$\lim_{x \rightarrow 0^-} f(x) = \lim_{x \rightarrow 0^-} \frac{e^x - 1}{e^x + 1} = \frac{0 - 1}{0 + 1} = -1$$

Similarly,

$$\lim_{x \rightarrow 0^-} f(x) = \lim_{x \rightarrow 0^-} \frac{e^{\frac{1}{x}} - 1}{\frac{1}{e^x} - 1}$$

$$= \lim_{x \rightarrow 0^-} \frac{1 - \frac{1}{e^x}}{1 - \frac{1}{e^x}} = \lim_{x \rightarrow 0^-} \frac{1 - e^{-x}}{1 - e^{-x}} = 1$$

Thus $\lim_{x \rightarrow 0^-} f(x) \neq \lim_{x \rightarrow 0^+} f(x)$, therefore, $\lim_{x \rightarrow 0} f(x)$ does not exist. Hence f is discontinuous at $x = 0$.

Example 21 Let $f(x) = \begin{cases} \frac{1 - \cos 4x}{x^2}, & \text{if } x \neq 0 \\ a, & \text{if } x = 0 \end{cases}$

$\frac{\sqrt{x}}{\sqrt{16 - \sqrt{x} - 4}}, \text{ if } x > 0$

For what value of a , f is continuous at $x = 0$?

Solution Here $f(0) = a$. Left hand limit of f at 0 is

$$\lim_{x \rightarrow 0^-} f(x) = \lim_{x \rightarrow 0^-} \frac{1 - \cos 4x}{x^2} = \lim_{x \rightarrow 0^-} \frac{2 \sin^2 2x}{x^2}$$

$$= \lim_{2x \rightarrow 0} 8 \frac{\sin^2 2x}{2x^2} = 8 (1)^2 = 8.$$

and right hand limit of f at 0 is

$$\lim_{x \rightarrow 0^+} f(x) = \lim_{x \rightarrow 0^+} \frac{\sqrt{x}}{\sqrt{16 - \sqrt{x} - 4}}$$

$$= \lim_{x \rightarrow 0^+} \frac{\sqrt{x}(\sqrt{16 - \sqrt{x} - 4})}{(\sqrt{16 - \sqrt{x} - 4})(\sqrt{16 - \sqrt{x} - 4})}$$

$$= \lim_{x \rightarrow 0} \frac{\sqrt{x}(\sqrt{16 - \sqrt{x}} - 4)}{16 - \sqrt{x} - 16} = \lim_{x \rightarrow 0} \frac{\sqrt{16 - \sqrt{x}} - 4}{8}$$

Thus, $\lim_{x \rightarrow 0} f(x) = \lim_{x \rightarrow 0} f(x) = 8$. Hence f is continuous at $x = 0$ only if $a = 8$.

Example 22 Examine the differentiability of the function f defined by

$$f(x) = \begin{cases} 2x + 3, & \text{if } 3 < x < 2 \\ x + 1, & \text{if } -2 < x < 0 \\ x + 2, & \text{if } 0 < x < 1 \end{cases}$$

Solution The only doubtful points for differentiability of $f(x)$ are $x = -2$ and $x = 0$. Differentiability at $x = -2$.

$$\begin{aligned} \text{Now } Lf'(-2) &= \lim_{h \rightarrow 0} \frac{f(-2 + h) - f(-2)}{h} \\ &= \lim_{h \rightarrow 0} \frac{2(-2 + h) + 3 - (-2 + 1)}{h} = \lim_{h \rightarrow 0} \frac{2h}{h} = \lim_{h \rightarrow 0} 2 = 2. \end{aligned}$$

$$\begin{aligned} \text{and } Rf'(-2) &= \lim_{h \rightarrow 0} \frac{f(-2 + h) - f(-2)}{h} \\ &= \lim_{h \rightarrow 0} \frac{-2 + h + 1 - (-2 + 1)}{h} \\ &= \lim_{h \rightarrow 0} \frac{h - 1 - (-1)}{h} = \lim_{h \rightarrow 0} \frac{h}{h} = 1 \end{aligned}$$

Thus $Rf'(-2) \neq Lf'(-2)$. Therefore f is not differentiable at $x = -2$. Similarly, for differentiability at $x = 0$, we have

$$\begin{aligned} Lf'(0) &= \lim_{h \rightarrow 0} \frac{f(0 + h) - f(0)}{h} \\ &= \lim_{h \rightarrow 0} \frac{0 + h + 1 - (0 + 2)}{h} \\ &= \lim_{h \rightarrow 0} \frac{h - 1}{h} = \lim_{h \rightarrow 0} \left(1 - \frac{1}{h}\right) \end{aligned}$$

which does not exist. Hence f is not differentiable at $x = 0$.

Example 23 Differentiate $\tan^{-1} \frac{\sqrt{1-x^2}}{x}$ with respect to $\cos^{-1} 2x\sqrt{1-x^2}$, where

$$x = \frac{1}{\sqrt{2}}.$$

Solution Let $u = \tan^{-1} \frac{\sqrt{1-x^2}}{x}$ and $v = \cos^{-1} 2x\sqrt{1-x^2}$.

We want to find $\frac{du}{dv} \cdot \frac{dv}{dx}$

Now $u = \tan^{-1} \frac{\sqrt{1-x^2}}{x}$. Put $x = \sin\theta$. $\left(\frac{\pi}{4} < \theta < \frac{\pi}{2}\right)$.

Then $u = \tan^{-1} \frac{\sqrt{1-\sin^2\theta}}{\sin\theta} = \tan^{-1}(\cot\theta)$

$$= \tan^{-1} \left\{ \tan\left(\frac{\pi}{2} - \theta\right) \right\} = \frac{\pi}{2} - \theta = \frac{\pi}{2} - \sin^{-1}x$$

Hence $\frac{du}{dx} = \frac{1}{\sqrt{1-x^2}}$.

Now $v = \cos^{-1}(2x\sqrt{1-x^2})$

$$= \frac{\pi}{2} - \sin^{-1}(2x\sqrt{1-x^2})$$

$$= \frac{\pi}{2} - \sin^{-1}(2\sin\theta\sqrt{1-\sin^2\theta}) = \frac{\pi}{2} - \sin^{-1}(\sin 2\theta)$$

$$= \frac{\pi}{2} - \sin^{-1}\{\sin(\pi - 2\theta)\} \quad \left[\text{since } \frac{\pi}{2} < 2\theta < \pi\right]$$

$$= \frac{1}{2} (2) = \frac{2}{2} = 1$$

$$\Rightarrow v = \frac{1}{2} + 2\sin^{-1}x$$

$$\Rightarrow \frac{dv}{dx} = \frac{2}{\sqrt{1-x^2}}$$

Hence

$$\frac{du}{dv} = \frac{dx}{dv} = \frac{-1}{\frac{2}{\sqrt{1-x^2}}} = \frac{-1}{2} \cdot \frac{\sqrt{1-x^2}}{1}$$

Objective Type Questions

Choose the correct answer from the given four options in each of the Examples 24 to 35.

Example 24 The function $f(x) = \begin{cases} \frac{\sin x}{x} \cos x, & \text{if } x \neq 0 \\ k, & \text{if } x = 0 \end{cases}$

is continuous at $x = 0$, then the value of k is

- (A) 3 (B) 2
(C) 1 (D) 1.5

Solution (B) is the Correct answer.

Example 25 The function $f(x) = [x]$, where $[x]$ denotes the greatest integer function, is continuous at

- (A) 4 (B) -2
(C) 1 (D) 1.5

Solution (D) is the correct answer. The greatest integer function $[x]$ is discontinuous at all integral values of x . Thus D is the correct answer.

Example 26 The number of points at which the function $f(x) = \frac{1}{x - [x]}$ is not continuous is

- (A) 1 (B) 2
(C) 3 (D) none of these

Solution (D) is the correct answer. As $x - [x] = 0$, when x is an integer so $f(x)$ is discontinuous for all $x \in \mathbf{Z}$.

Example 27 The function given by $f(x) = \tan x$ is discontinuous on the set

- (A) $n : n \in \mathbf{Z}$ (B) $2n : n \in \mathbf{Z}$
 (C) $(2n - 1)\frac{\pi}{2} : n \in \mathbf{Z}$ (D) $\frac{n}{2} : n \in \mathbf{Z}$

Solution C is the correct answer.

Example 28 Let $f(x) = |\cos x|$. Then,

- (A) f is everywhere differentiable.
 (B) f is everywhere continuous but not differentiable at $x = n\pi, n \in \mathbf{Z}$.
 (C) f is everywhere continuous but not differentiable at $x = (2n + 1)\frac{\pi}{2}, n \in \mathbf{Z}$.
 (D) none of these.

Solution C is the correct answer.

Example 29 The function $f(x) = |x| + |x - 1|$ is

- (A) continuous at $x = 0$ as well as at $x = 1$.
 (B) continuous at $x = 1$ but not at $x = 0$.
 (C) discontinuous at $x = 0$ as well as at $x = 1$.
 (D) continuous at $x = 0$ but not at $x = 1$.

Solution Correct answer is A.

Example 30 The value of k which makes the function defined by

$$f(x) = \begin{cases} \sin \frac{1}{x}, & \text{if } x \neq 0 \\ k, & \text{if } x = 0 \end{cases}, \text{ continuous at } x = 0 \text{ is}$$

- (A) 8 (B) 1
 (C) -1 (D) none of these

Solution (D) is the correct answer. Indeed $\lim_{x \rightarrow 0} \sin \frac{1}{x}$ does not exist.

Example 31 The set of points where the functions f given by $f(x) = |x - 3| \cos x$ is differentiable is

- (A) \mathbf{R} (B) $\mathbf{R} - \{3\}$
 (C) $(0, \infty)$ (D) none of these

Solution B is the correct answer.

Example 32 Differential coefficient of $\sec(\tan^{-1}x)$ w.r.t. x is

- (A) $\frac{x}{\sqrt{1+x^2}}$ (B) $\frac{x}{1+x^2}$
 (C) $x\sqrt{1+x^2}$ (D) $\frac{1}{\sqrt{1+x^2}}$

Solution (A) is the correct answer.

Example 33 If $u = \sin^{-1}\left(\frac{2x}{1+x^2}\right)$ and $v = \tan^{-1}\left(\frac{2x}{1-x^2}\right)$, then $\frac{du}{dv}$ is

- (A) $\frac{1}{2}$ (B) x (C) $\frac{1-x^2}{1+x^2}$ (D) 1

Solution (D) is the correct answer.

Example 34 The value of c in Rolle's Theorem for the function $f(x) = e^x \sin x$, $x \in [0, \pi]$ is

- (A) $\frac{\pi}{6}$ (B) $\frac{\pi}{4}$ (C) $\frac{\pi}{2}$ (D) $\frac{3\pi}{4}$

Solution (D) is the correct answer.

Example 35 The value of c in Mean value theorem for the function $f(x) = x(x-2)$, $x \in [1, 2]$ is

- (A) $\frac{3}{2}$ (B) $\frac{2}{3}$ (C) $\frac{1}{2}$ (D) $\frac{3}{2}$

Solution (A) is the correct answer.

Example 36 Match the following

COLUMN-I

COLUMN-II

- (A) If a function $f(x) = \begin{cases} \frac{\sin 3x}{x}, & \text{if } x \neq 0 \\ \frac{k}{2}, & \text{if } x = 0 \end{cases}$ (a) $|x|$

is continuous at $x = 0$, then k is equal to

- (B) Every continuous function is differentiable (b) True
 (C) An example of a function which is continuous everywhere but not differentiable at exactly one point (c) 6
 (D) The identity function i.e. $f(x) = x \forall x \in \mathbb{R}$ is a continuous function (d) False

Solution $A \rightarrow c, B \rightarrow d, C \rightarrow a, D \rightarrow b$

Fill in the blanks in each of the Examples 37 to 41.

Example 37 The number of points at which the function $f(x) = \frac{1}{\log|x|}$ is discontinuous is _____.

Solution The given function is discontinuous at $x = 0, \pm 1$ and hence the number of points of discontinuity is 3.

Example 38 If $f(x) = \begin{cases} ax+1 & \text{if } x \geq 1 \\ x+2 & \text{if } x < 1 \end{cases}$ is continuous, then a should be equal to _____.

Solution $a = 2$

Example 39 The derivative of $\log_{10} x$ w.r.t. x is _____.

Solution $(\log_{10} e) \frac{1}{x}$.

Example 40 If $y = \sec^{-1} \left(\frac{\sqrt{x}+1}{\sqrt{x}-1} \right) + \sin^{-1} \left(\frac{\sqrt{x}-1}{\sqrt{x}+1} \right)$, then $\frac{dy}{dx}$ is equal to _____.

Solution 0.

Example 41 The derivative of $\sin x$ w.r.t. $\cos x$ is _____.

Solution $-\cot x$

State whether the statements are True or False in each of the Exercises 42 to 46.

Example 42 For continuity, at $x = a$, each of $\lim_{x \rightarrow a^+} f(x)$ and $\lim_{x \rightarrow a^-} f(x)$ is equal to $f(a)$.

Solution True.

Example 43 $y = |x - 1|$ is a continuous function.

Solution True.

Example 44 A continuous function can have some points where limit does not exist.

Solution False.

Example 45 $|\sin x|$ is a differentiable function for every value of x .

Solution False.

Example 46 $\cos |x|$ is differentiable everywhere.

Solution True.

5.3 EXERCISE

Short Answer (S.A.)

1. Examine the continuity of the function

$$f(x) = x^3 + 2x^2 - 1 \text{ at } x = 1$$

Find which of the functions in Exercises 2 to 10 is continuous or discontinuous at the indicated points:

$$2. f(x) = \begin{cases} 3x+5, & \text{if } x \geq 2 \\ x^2, & \text{if } x < 2 \end{cases}$$

at $x=2$

$$3. f(x) = \begin{cases} \frac{1 - \cos 2x}{x^2}, & \text{if } x \neq 0 \\ 5, & \text{if } x = 0 \end{cases}$$

at $x=0$

$$4. f(x) = \begin{cases} \frac{2x^2 - 3x - 2}{x - 2}, & \text{if } x \neq 2 \\ 5, & \text{if } x = 2 \end{cases}$$

at $x=2$

$$5. f(x) = \begin{cases} \frac{|x-4|}{2(x-4)}, & \text{if } x \neq 4 \\ 0, & \text{if } x = 4 \end{cases}$$

at $x=4$

$$6. f(x) = \begin{cases} |x| \cos \frac{1}{x}, & \text{if } x \neq 0 \\ 0, & \text{if } x = 0 \end{cases}$$

at $x=0$

$$7. f(x) = \begin{cases} |x-a| \sin \frac{1}{x-a}, & \text{if } x \neq a \\ 0, & \text{if } x = a \end{cases}$$

at $x=a$

$$8. f(x) = \begin{cases} \frac{1}{e^x}, & \text{if } x \neq 0 \\ 1 + e^{\frac{1}{x}}, & \text{if } x = 0 \end{cases}$$

at $x=0$

$$9. f(x) = \begin{cases} \frac{x^2}{2}, & \text{if } 0 \leq x \leq 1 \\ 2x^2 - 3x + \frac{3}{2}, & \text{if } 1 < x \leq 2 \end{cases}$$

at $x=1$

10. $f(x) = |x| + |x-1|$ at $x=1$

Find the value of k in each of the Exercises 11 to 14 so that the function f is continuous at the indicated point:

$$11. f(x) = \begin{cases} 3x - 8, & \text{if } x < 5 \\ 2k, & \text{if } x = 5 \end{cases} \text{ at } x = 5$$

$$12. f(x) = \begin{cases} \frac{2x^2 - 16}{4x - 16}, & \text{if } x < 2 \\ k, & \text{if } x = 2 \end{cases} \text{ at } x = 2$$

$$13. f(x) = \begin{cases} \frac{\sqrt{1 - kx} - \sqrt{1 + kx}}{x}, & \text{if } -1 < x < 0 \\ \frac{2x - 1}{x - 1}, & \text{if } 0 < x < 1 \end{cases} \text{ at } x = 0$$

$$14. f(x) = \begin{cases} \frac{1 - \cos kx}{x \sin x}, & \text{if } x \neq 0 \\ \frac{1}{2}, & \text{if } x = 0 \end{cases} \text{ at } x = 0$$

15. Prove that the function f defined by

$$f(x) = \begin{cases} \frac{x}{|x| + 2x^2}, & x \neq 0 \\ k, & x = 0 \end{cases}$$

remains discontinuous at $x = 0$, regardless the choice of k .

16. Find the values of a and b such that the function f defined by

$$f(x) = \begin{cases} \frac{x-4}{|x-4|} + a, & \text{if } x < 4 \\ a+b, & \text{if } x = 4 \\ \frac{x-4}{|x-4|} + b, & \text{if } x > 4 \end{cases}$$

is a continuous function at $x = 4$.

17. Given the function $f(x) = \frac{1}{x+2}$. Find the points of discontinuity of the composite function $y = f(f(x))$.

18. Find all points of discontinuity of the function $f(t) = \frac{1}{t^2 + t - 2}$, where $t = \frac{1}{x-1}$.

19. Show that the function $f(x) = |\sin x + \cos x|$ is continuous at $x = \pi$.

Examine the differentiability of f , where f is defined by

$$20. f(x) = \begin{cases} x[x], & \text{if } 0 \leq x < 2 \\ (x-1)x, & \text{if } 2 \leq x < 3 \end{cases}$$

at $x = 2$.

$$21. f(x) = \begin{cases} x^2 \sin \frac{1}{x} & , \text{if } x \neq 0 \\ 0 & , \text{if } x = 0 \end{cases}$$

at $x = 0$.

$$22. f(x) = \begin{cases} 1+x & , \text{if } x \leq 2 \\ 5-x & , \text{if } x > 2 \end{cases}$$

at $x = 2$.

23. Show that $f(x) = |x-5|$ is continuous but not differentiable at $x = 5$.

24. A function $f: \mathbf{R} \rightarrow \mathbf{R}$ satisfies the equation $f(x+y) = f(x)f(y)$ for all $x, y \in \mathbf{R}$, $f(x) \neq 0$. Suppose that the function is differentiable at $x = 0$ and $f'(0) = 2$. Prove that $f'(x) = 2f(x)$.

Differentiate each of the following w.r.t. x (Exercises 25 to 43):

$$25. 2^{\cos^2 x} \qquad 26. \frac{8^x}{x^8} \qquad 27. \log(x + \sqrt{x^2 + a})$$

$$28. \log[\log(\log x^5)] \qquad 29. \sin \sqrt{x} + \cos^2 \sqrt{x} \qquad 30. \sin^n(ax^2 + bx + c)$$

$$31. \cos(\tan \sqrt{x+1}) \qquad 32. \sin x^2 + \sin^2 x + \sin^2(x^2) \qquad 33. \sin^{-1}\left(\frac{1}{\sqrt{x+1}}\right)$$

$$34. (\sin x)^{\cos x} \qquad 35. \sin^m x \cdot \cos^n x \qquad 36. (x+1)^2 (x+2)^3 (x+3)^4$$

37. $\cos^{-1}\left(\frac{\sin x + \cos x}{\sqrt{2}}\right), -\frac{\pi}{4} < x < \frac{\pi}{4}$
38. $\tan^{-1}\left(\frac{\sqrt{1 - \cos x}}{\sqrt{1 + \cos x}}\right), -\frac{\pi}{4} < x < \frac{\pi}{4}$
39. $\tan^{-1}(\sec x + \tan x), -\frac{\pi}{2} < x < \frac{\pi}{2}$
40. $\tan^{-1}\left(\frac{a \cos x - b \sin x}{b \cos x + a \sin x}\right), -\frac{\pi}{2} < x < \frac{\pi}{2}$ and $\frac{a}{b} \tan x > -1$
41. $\sec^{-1}\left(\frac{1}{4x^3 - 3x}\right), 0 < x < \frac{1}{\sqrt{2}}$
42. $\tan^{-1} \frac{3a^2x - x^3}{a^3 - 3ax^2}, \frac{1}{\sqrt{3}} < \frac{x}{a} < \frac{1}{\sqrt{3}}$
43. $\tan^{-1}\left(\frac{\sqrt{1+x^2} + \sqrt{1-x^2}}{\sqrt{1+x^2} - \sqrt{1-x^2}}\right), -1 < x < 1, x \neq 0$

Find $\frac{dy}{dx}$ of each of the functions expressed in parametric form in Exercises from 44 to 48.

44. $x = t + \frac{1}{t}, y = t - \frac{1}{t}$
45. $x = e^\theta \left(\theta + \frac{1}{\theta}\right), y = e^{-\theta} \left(\theta - \frac{1}{\theta}\right)$
46. $x = 3\cos\theta - 2\cos^3\theta, y = 3\sin\theta - 2\sin^3\theta.$
47. $\sin x = \frac{2t}{1+t^2}, \tan y = \frac{2t}{1-t^2}.$
48. $x = \frac{1 + \log t}{t^2}, y = \frac{3 + 2 \log t}{t}.$
49. If $x = e^{\cos 2t}$ and $y = e^{\sin 2t}$, prove that $\frac{dy}{dx} = \frac{-y \log x}{x \log y}.$
50. If $x = a \sin 2t (1 + \cos 2t)$ and $y = b \cos 2t (1 - \cos 2t)$, show that $\left(\frac{dy}{dx}\right)_{\text{at } t = \frac{\pi}{4}} = \frac{b}{a}.$
51. If $x = 3 \sin t - \sin 3t, y = 3 \cos t - \cos 3t$, find $\frac{dy}{dx}$ at $t = \frac{\pi}{3}.$

52. Differentiate $\frac{x}{\sin x}$ w.r.t. $\sin x$.

53. Differentiate $\tan^{-1} \left(\frac{\sqrt{1+x^2}-1}{x} \right)$ w.r.t. $\tan^{-1} x$ when $x \neq 0$.

Find $\frac{dy}{dx}$ when x and y are connected by the relation given in each of the Exercises 54 to 57.

54. $\sin(xy) + \frac{x}{y} = x^2 - y$

55. $\sec(x+y) = xy$

56. $\tan^{-1}(x^2 + y^2) = a$

57. $(x^2 + y^2)^2 = xy$

58. If $ax^2 + 2hxy + by^2 + 2gx + 2fy + c = 0$, then show that $\frac{dy}{dx} \cdot \frac{dx}{dy} = 1$.

59. If $x = e^{\frac{x}{y}}$, prove that $\frac{dy}{dx} = \frac{x-y}{x \log x}$.

60. If $y^x = e^{y-x}$, prove that $\frac{dy}{dx} = \frac{(1 + \log y)^2}{\log y}$.

61. If $y = (\cos x)^{(\cos x)^{(\cos x)^{\dots \infty}}}$, show that $\frac{dy}{dx} = \frac{y^2 \tan x}{y \log \cos x - 1}$.

62. If $x \sin(a+y) + \sin a \cos(a+y) = 0$, prove that $\frac{dy}{dx} = \frac{\sin^2(a+y)}{\sin a}$.

63. If $\sqrt{1-x^2} + \sqrt{1-y^2} = a(x-y)$, prove that $\frac{dy}{dx} = \sqrt{\frac{1-y^2}{1-x^2}}$.

64. If $y = \tan^{-1} x$, find $\frac{d^2 y}{dx^2}$ in terms of y alone.

Verify the Rolle's theorem for each of the functions in Exercises 65 to 69.

65. $f(x) = x(x-1)^2$ in $[0, 1]$.

66. $f(x) = \sin^4 x + \cos^4 x$ in $\left[0, \frac{\pi}{2}\right]$.

67. $f(x) = \log(x^2 + 2) - \log 3$ in $[-1, 1]$.

68. $f(x) = x(x+3)e^{-x/2}$ in $[-3, 0]$.

69. $f(x) = \sqrt{4-x^2}$ in $[-2, 2]$.

70. Discuss the applicability of Rolle's theorem on the function given by

$$f(x) = \begin{cases} x^2 - 1, & \text{if } 0 \leq x < 1 \\ 3 - x, & \text{if } 1 \leq x \leq 2 \end{cases}$$

71. Find the points on the curve $y = (\cos x - 1)$ in $[0, 2\pi]$, where the tangent is parallel to x -axis.

72. Using Rolle's theorem, find the point on the curve $y = x(x-4)$, $x \in [0, 4]$, where the tangent is parallel to x -axis.

Verify mean value theorem for each of the functions given Exercises 73 to 76.

73. $f(x) = \frac{1}{4x-1}$ in $[1, 4]$.

74. $f(x) = x^3 - 2x^2 - x + 3$ in $[0, 1]$.

75. $f(x) = \sin x - \sin 2x$ in $[0, \pi]$.

76. $f(x) = \sqrt{25-x^2}$ in $[1, 5]$.

77. Find a point on the curve $y = (x-3)^2$, where the tangent is parallel to the chord joining the points $(3, 0)$ and $(4, 1)$.

78. Using mean value theorem, prove that there is a point on the curve $y = 2x^2 - 5x + 3$ between the points A(1, 0) and B(2, 1), where tangent is parallel to the chord AB. Also, find that point.

Long Answer (L.A.)

79. Find the values of p and q so that

$$f(x) = \begin{cases} x^2 + 3x + p, & \text{if } x \leq 1 \\ qx + 2 & , \text{if } x > 1 \end{cases}$$

is differentiable at $x = 1$.

80. If $x^m \cdot y^n = (x + y)^{m+n}$, prove that

(i) $\frac{dy}{dx} = \frac{y}{x}$ and (ii) $\frac{d^2y}{dx^2} = 0$.

81. If $x = \sin t$ and $y = \sin pt$, prove that $(1-x^2) \frac{d^2y}{dx^2} - x \frac{dy}{dx} + p^2y = 0$.

82. Find $\frac{dy}{dx}$, if $y = x^{\tan x} + \sqrt{\frac{x^2+1}{2}}$.

Objective Type Questions

Choose the correct answers from the given four options in each of the Exercises 83 to 96.

83. If $f(x) = 2x$ and $g(x) = \frac{x^2}{2} + 1$, then which of the following can be a discontinuous function

(A) $f(x) + g(x)$

(B) $f(x) - g(x)$

(C) $f(x) \cdot g(x)$

(D) $\frac{g(x)}{f(x)}$

84. The function $f(x) = \frac{4-x^2}{4x-x^3}$ is

(A) discontinuous at only one point

(B) discontinuous at exactly two points

(C) discontinuous at exactly three points

(D) none of these

85. The set of points where the function f given by $f(x) = |2x-1| \sin x$ is differentiable is

(A) \mathbf{R}

(B) $\mathbf{R} - \left\{ \frac{1}{2} \right\}$

- (C) $(0, \infty)$ (D) none of these
- 86.** The function $f(x) = \cot x$ is discontinuous on the set
 (A) $\{x = n\pi : n \in \mathbf{Z}\}$ (B) $\{x = 2n\pi : n \in \mathbf{Z}\}$
 (C) $\left\{x = (2n+1)\frac{\pi}{2} ; n \in \mathbf{Z}\right\}$ (iv) $\left\{x = \frac{n\pi}{2} ; n \in \mathbf{Z}\right\}$
- 87.** The function $f(x) = e^{|x|}$ is
 (A) continuous everywhere but not differentiable at $x = 0$
 (B) continuous and differentiable everywhere
 (C) not continuous at $x = 0$
 (D) none of these.
- 88.** If $f(x) = x^2 \sin \frac{1}{x}$, where $x \neq 0$, then the value of the function f at $x = 0$, so that the function is continuous at $x = 0$, is
 (A) 0 (B) -1
 (C) 1 (D) none of these
- 89.** If $f(x) = \begin{cases} mx+1 & , \text{if } x \leq \frac{\pi}{2} \\ \sin x + n, & \text{if } x > \frac{\pi}{2} \end{cases}$, is continuous at $x = \frac{\pi}{2}$, then
 (A) $m = 1, n = 0$ (B) $m = \frac{n\pi}{2} + 1$
 (C) $n = \frac{m\pi}{2}$ (D) $m = n = \frac{\pi}{2}$
- 90.** Let $f(x) = |\sin x|$. Then
 (A) f is everywhere differentiable
 (B) f is everywhere continuous but not differentiable at $x = n\pi, n \in \mathbf{Z}$.
 (C) f is everywhere continuous but not differentiable at $x = (2n + 1) \frac{\pi}{2}$,
 $n \in \mathbf{Z}$.
 (D) none of these
- 91.** If $y = \log \left(\frac{1-x^2}{1+x^2} \right)$, then $\frac{dy}{dx}$ is equal to

(A) $\frac{4x^3}{1-x^4}$

(B) $\frac{-4x}{1-x^4}$

(C) $\frac{1}{4-x^4}$

(D) $\frac{-4x^3}{1-x^4}$

92. If $y = \sqrt{\sin x + y}$, then $\frac{dy}{dx}$ is equal to

(A) $\frac{\cos x}{2y-1}$

(B) $\frac{\cos x}{1-2y}$

(C) $\frac{\sin x}{1-2y}$

(D) $\frac{\sin x}{2y-1}$

93. The derivative of $\cos^{-1}(2x^2 - 1)$ w.r.t. $\cos^{-1}x$ is

(A) 2

(B) $\frac{-1}{2\sqrt{1-x^2}}$

(C) $\frac{2}{x}$

(D) $1 - x^2$

94. If $x = t^2$, $y = t^3$, then $\frac{d^2y}{dx^2}$ is

(A) $\frac{3}{2}$

(B) $\frac{3}{4t}$

(C) $\frac{3}{2t}$

(D) $\frac{3}{2t}$

95. The value of c in Rolle's theorem for the function $f(x) = x^3 - 3x$ in the interval $[0, \sqrt{3}]$ is

(A) 1

(B) -1

(C) $\frac{3}{2}$

(D) $\frac{1}{3}$

96. For the function $f(x) = x + \frac{1}{x}$, $x \in [1, 3]$, the value of c for mean value theorem is

(A) 1

(B) $\sqrt{3}$

(C) 2

(D) none of these

Fill in the blanks in each of the Exercises 97 to 101:

97. An example of a function which is continuous everywhere but fails to be differentiable exactly at two points is _____.

98. Derivative of x^2 w.r.t. x^3 is _____.

99. If $f(x) = |\cos x|$, then $f' \frac{1}{4} =$ _____.

100. If $f(x) = |\cos x - \sin x|$, then $f' \frac{1}{3} =$ _____.

101. For the curve $\sqrt{x} - \sqrt{y} - 1$, $\frac{dy}{dx}$ at $\left(\frac{1}{4}, \frac{1}{4}\right)$ is _____.

State **True** or **False** for the statements in each of the Exercises 102 to 106.

102. Rolle's theorem is applicable for the function $f(x) = |x - 1|$ in $[0, 2]$.

103. If f is continuous on its domain D , then $|f|$ is also continuous on D .

104. The composition of two continuous function is a continuous function.

105. Trigonometric and inverse - trigonometric functions are differentiable in their respective domain.

106. If $f \cdot g$ is continuous at $x = a$, then f and g are separately continuous at $x = a$.



APPLICATION OF DERIVATIVES

6.1 Overview

6.1.1 Rate of change of quantities

For the function $y = f(x)$, $\frac{d}{dx}(f(x))$ represents the rate of change of y with respect to x .

Thus if 's' represents the distance and 't' the time, then $\frac{ds}{dt}$ represents the rate of change of distance with respect to time.

6.1.2 Tangents and normals

A line touching a curve $y = f(x)$ at a point (x_1, y_1) is called the tangent to the curve at

that point and its equation is given $y - y_1 = \left(\frac{dy}{dx}\right)_{(x_1, y_1)}(x - x_1)$.

The normal to the curve is the line perpendicular to the tangent at the point of contact, and its equation is given as:

$$y - y_1 = \frac{-1}{\left(\frac{dy}{dx}\right)_{(x_1, y_1)}}(x - x_1)$$

The angle of intersection between two curves is the angle between the tangents to the curves at the point of intersection.

6.1.3 Approximation

Since $f'(x) = \lim_{\Delta x \rightarrow 0} \frac{f(x + \Delta x) - f(x)}{\Delta x}$, we can say that $f'(x)$ is approximately equal

to $\frac{f(x + \Delta x) - f(x)}{\Delta x}$

\Rightarrow approximate value of $f(x + \Delta x) = f(x) + \Delta x \cdot f'(x)$.

6.1.4 Increasing/decreasing functions

A continuous function in an interval (a, b) is :

- (i) strictly increasing if for all $x_1, x_2 \in (a, b)$, $x_1 < x_2 \Rightarrow f(x_1) < f(x_2)$ or for all $x \in (a, b)$, $f'(x) > 0$
- (ii) strictly decreasing if for all $x_1, x_2 \in (a, b)$, $x_1 < x_2 \Rightarrow f(x_1) > f(x_2)$ or for all $x \in (a, b)$, $f'(x) < 0$

6.1.5 Theorem : Let f be a continuous function on $[a, b]$ and differentiable in (a, b) then

- (i) f is increasing in $[a, b]$ if $f'(x) > 0$ for each $x \in (a, b)$
- (ii) f is decreasing in $[a, b]$ if $f'(x) < 0$ for each $x \in (a, b)$
- (iii) f is a constant function in $[a, b]$ if $f'(x) = 0$ for each $x \in (a, b)$.

6.1.6 Maxima and minima

Local Maximum/Local Minimum for a real valued function f

A point c in the interior of the domain of f , is called

- (i) local maxima, if there exists an $h > 0$, such that $f(c) > f(x)$, for all x in $(c - h, c + h)$.

The value $f(c)$ is called the local maximum value of f .

- (ii) local minima if there exists an $h > 0$ such that $f(c) < f(x)$, for all x in $(c - h, c + h)$.

The value $f(c)$ is called the local minimum value of f .

A function f defined over $[a, b]$ is said to have maximum (or absolute maximum) at $x = c$, $c \in [a, b]$, if $f(x) \leq f(c)$ for all $x \in [a, b]$.

Similarly, a function $f(x)$ defined over $[a, b]$ is said to have a minimum [or absolute minimum] at $x = d$, if $f(x) \geq f(d)$ for all $x \in [a, b]$.

6.1.7 Critical point of f : A point c in the domain of a function f at which either $f'(c) = 0$ or f is not differentiable is called a critical point of f .

Working rule for finding points of local maxima or local minima:

- (a) **First derivative test:**
 - (i) If $f'(x)$ changes sign from positive to negative as x increases through c , then c is a point of local maxima, and $f(c)$ is local maximum value.

- (ii) If $f'(x)$ changes sign from negative to positive as x increases through c , then c is a point of local minima, and $f(c)$ is local minimum value.
- (iii) If $f'(x)$ does not change sign as x increases through c , then c is neither a point of local minima nor a point of local maxima. Such a point is called a point of inflection.
- (b) **Second Derivative test:** Let f be a function defined on an interval I and $c \in I$. Let f be twice differentiable at c . Then
- (i) $x = c$ is a point of local maxima if $f'(c) = 0$ and $f''(c) < 0$. In this case $f(c)$ is then the local maximum value.
- (ii) $x = c$ is a point of local minima if $f'(c) = 0$ and $f''(c) > 0$. In this case $f(c)$ is the local minimum value.
- (iii) The test fails if $f'(c) = 0$ and $f''(c) = 0$. In this case, we go back to first derivative test.

6.1.8 Working rule for finding absolute maxima and or absolute minima :

Step 1 : Find all the critical points of f in the given interval.

Step 2 : At all these points and at the end points of the interval, calculate the values of f .

Step 3 : Identify the maximum and minimum values of f out of the values calculated in step 2. The maximum value will be the absolute maximum value of f and the minimum value will be the absolute minimum value of f .

6.2 Solved Examples

Short Answer Type (S.A.)

Example 1 For the curve $y = 5x - 2x^3$, if x increases at the rate of 2 units/sec, then how fast is the slope of curve changing when $x = 3$?

Solution Slope of curve = $\frac{dy}{dx} = 5 - 6x^2$

$$\Rightarrow \frac{d}{dt} \left(\frac{dy}{dx} \right) = -12x \cdot \frac{dx}{dt}$$

$$= -12 \cdot (3) \cdot (2)$$

$$= -72 \text{ units/sec.}$$

Thus, slope of curve is decreasing at the rate of 72 units/sec when x is increasing at the rate of 2 units/sec.

Example 2 Water is dripping out from a conical funnel of semi-vertical angle $\frac{\pi}{4}$ at the uniform rate of $2 \text{ cm}^2/\text{sec}$ in the surface area, through a tiny hole at the vertex of the bottom. When the slant height of cone is 4 cm, find the rate of decrease of the slant height of water.

Solution If s represents the surface area, then

$$\frac{ds}{dt} = 2 \text{ cm}^2/\text{sec}$$

$$s = \pi r.l = \pi l \cdot \sin \frac{\pi}{4} \cdot l = \frac{\pi}{\sqrt{2}} l^2$$

$$\text{Therefore, } \frac{ds}{dt} = \frac{2\pi}{\sqrt{2}} l \cdot \frac{dl}{dt} = \sqrt{2}\pi l \cdot \frac{dl}{dt}$$

$$\text{when } l = 4 \text{ cm, } \frac{dl}{dt} = \frac{1}{\sqrt{2}\pi \cdot 4} \cdot 2 = \frac{1}{2\sqrt{2}\pi} = \frac{\sqrt{2}}{4\pi} \text{ cm/s.}$$

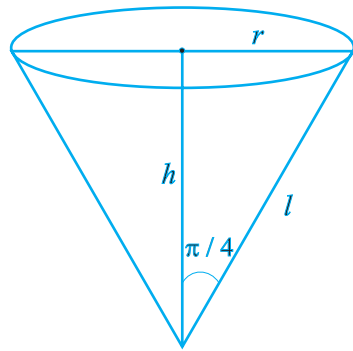

Fig. 6.1

Example 3 Find the angle of intersection of the curves $y^2 = x$ and $x^2 = y$.

Solution Solving the given equations, we have $y^2 = x$ and $x^2 = y \Rightarrow x^4 = x$ or $x^4 - x = 0$

$$\Rightarrow x(x^3 - 1) = 0 \Rightarrow x = 0, x = 1$$

$$\text{Therefore, } y = 0, y = 1$$

i.e. points of intersection are $(0, 0)$ and $(1, 1)$

$$\text{Further } y^2 = x \Rightarrow 2y \frac{dy}{dx} = 1 \Rightarrow \frac{dy}{dx} = \frac{1}{2y}$$

$$\text{and } x^2 = y \Rightarrow \frac{dy}{dx} = 2x.$$

At $(0, 0)$, the slope of the tangent to the curve $y^2 = x$ is parallel to y -axis and the tangent to the curve $x^2 = y$ is parallel to x -axis.

$$\Rightarrow \text{angle of intersection} = \frac{\pi}{2}$$

At $(1, 1)$, slope of the tangent to the curve $y_2 = x$ is equal to $\frac{1}{2}$ and that of $x^2 = y$ is 2.

$$\tan \theta = \left| \frac{2 - \frac{1}{2}}{1 + 1} \right| = \frac{3}{4} \quad \Rightarrow \quad \theta = \tan^{-1} \left(\frac{3}{4} \right)$$

Example 4 Prove that the function $f(x) = \tan x - 4x$ is strictly decreasing on $\left(\frac{-\pi}{3}, \frac{\pi}{3} \right)$.

Solution $f(x) = \tan x - 4x \Rightarrow f'(x) = \sec^2 x - 4$

When $\frac{-\pi}{3} < x < \frac{\pi}{3}$, $1 < \sec x < 2$

Therefore, $1 < \sec^2 x < 4 \Rightarrow -3 < (\sec^2 x - 4) < 0$

Thus for $\frac{-\pi}{3} < x < \frac{\pi}{3}$, $f'(x) < 0$

Hence f is strictly decreasing on $\left(\frac{-\pi}{3}, \frac{\pi}{3} \right)$.

Example 5 Determine for which values of x , the function $y = x^4 - \frac{4x^3}{3}$ is increasing and for which values, it is decreasing.

Solution $y = x^4 - \frac{4x^3}{3} \quad \Rightarrow \quad \frac{dy}{dx} = 4x^3 - 4x^2 = 4x^2(x - 1)$

Now, $\frac{dy}{dx} = 0 \Rightarrow x = 0, x = 1$.

Since $f'(x) < 0 \forall x \in (-\infty, 0) \cup (0, 1)$ and f is continuous in $(-\infty, 0]$ and $[0, 1]$. Therefore f is decreasing in $(-\infty, 1]$ and f is increasing in $[1, \infty)$.

Note: Here f is strictly decreasing in $(-\infty, 0) \cup (0, 1)$ and is strictly increasing in $(1, \infty)$.

Example 6 Show that the function $f(x) = 4x^3 - 18x^2 + 27x - 7$ has neither maxima nor minima.

Solution $f(x) = 4x^3 - 18x^2 + 27x - 7$

$$f'(x) = 12x^2 - 36x + 27 = 3(4x^2 - 12x + 9) = 3(2x - 3)^2$$

$$f'(x) = 0 \Rightarrow x = \frac{3}{2} \text{ (critical point)}$$

Since $f'(x) > 0$ for all $x < \frac{3}{2}$ and for all $x > \frac{3}{2}$

Hence $x = \frac{3}{2}$ is a point of inflexion i.e., neither a point of maxima nor a point of minima.

$x = \frac{3}{2}$ is the only critical point, and f has neither maxima nor minima.

Example 7 Using differentials, find the approximate value of $\sqrt{0.082}$

Solution Let $f(x) = \sqrt{x}$

Using $f(x + \Delta x) \approx f(x) + \Delta x \cdot f'(x)$, taking $x = .09$ and $\Delta x = -0.008$,

we get $f(0.09 - 0.008) = f(0.09) + (-0.008)f'(0.09)$

$$\Rightarrow \sqrt{0.082} = \sqrt{0.09} - 0.008 \cdot \left(\frac{1}{2\sqrt{0.09}} \right) = 0.3 - \frac{0.008}{0.6}$$

$$= 0.3 - 0.0133 = 0.2867.$$

Example 8 Find the condition for the curves $\frac{x^2}{a^2} - \frac{y^2}{b^2} = 1$; $xy = c^2$ to intersect orthogonally.

Solution Let the curves intersect at (x_1, y_1) . Therefore,

$$\frac{x^2}{a^2} - \frac{y^2}{b^2} = 1 \Rightarrow \frac{2x}{a^2} - \frac{2y}{b^2} \frac{dy}{dx} = 0 \Rightarrow \frac{dy}{dx} = \frac{b^2 x}{a^2 y}$$

$$\Rightarrow \text{slope of tangent at the point of intersection } (m_1) = \frac{b^2 x_1}{a^2 y_1}$$

$$\text{Again } xy = c^2 \Rightarrow x \frac{dy}{dx} + y = 0 \Rightarrow \frac{dy}{dx} = \frac{-y}{x} \Rightarrow m_2 = \frac{-y_1}{x_1}$$

$$\text{For orthogonality, } m_1 \times m_2 = -1 \Rightarrow \frac{b^2}{a^2} = 1 \text{ or } a^2 - b^2 = 0.$$

Example 9 Find all the points of local maxima and local minima of the function

$$f(x) = -\frac{3}{4}x^4 - 8x^3 - \frac{45}{2}x^2 + 105.$$

Solution $f'(x) = -3x^3 - 24x^2 - 45x$

$$= -3x(x^2 + 8x + 15) = -3x(x + 5)(x + 3)$$

$$f'(x) = 0 \Rightarrow x = -5, x = -3, x = 0$$

$$f''(x) = -9x^2 - 48x - 45$$

$$= -3(3x^2 + 16x + 15)$$

$$f''(0) = -45 < 0. \text{ Therefore, } x = 0 \text{ is point of local maxima}$$

$$f''(-3) = 18 > 0. \text{ Therefore, } x = -3 \text{ is point of local minima}$$

$$f''(-5) = -30 < 0. \text{ Therefore } x = -5 \text{ is point of local maxima.}$$

Example 10 Show that the local maximum value of $x + \frac{1}{x}$ is less than local minimum value.

Solution Let $y = x + \frac{1}{x} \Rightarrow \frac{dy}{dx} = 1 - \frac{1}{x^2}$,

$$\frac{dy}{dx} = 0 \Rightarrow x^2 = 1 \Rightarrow x = \pm 1.$$

$$\frac{d^2y}{dx^2} = + \frac{2}{x^3}, \text{ therefore } \frac{d^2y}{dx^2} (\text{at } x = 1) > 0 \text{ and } \frac{d^2y}{dx^2} (\text{at } x = -1) < 0.$$

Hence local maximum value of y is at $x = -1$ and the local maximum value $= -2$.

Local minimum value of y is at $x = 1$ and local minimum value $= 2$.

Therefore, local maximum value (-2) is less than local minimum value 2 .

Long Answer Type (L.A.)

Example 11 Water is dripping out at a steady rate of 1 cu cm/sec through a tiny hole at the vertex of the conical vessel, whose axis is vertical. When the slant height of water in the vessel is 4 cm, find the rate of decrease of slant height, where the vertical angle of the conical vessel is $\frac{\pi}{6}$.

Solution Given that $\frac{dv}{dt} = 1 \text{ cm}^3/\text{s}$, where v is the volume of water in the conical vessel.

From the Fig.6.2, $l = 4\text{cm}$, $h = l \cos \frac{\pi}{6} = \frac{\sqrt{3}}{2}l$ and $r = l \sin \frac{\pi}{6} = \frac{l}{2}$.

Therefore, $v = \frac{1}{3} \pi r^2 h = \frac{1}{3} \pi \frac{l^2}{4} \frac{\sqrt{3}}{2} l = \frac{\sqrt{3}}{24} \pi l^3$.

$$\frac{dv}{dt} = \frac{\sqrt{3}\pi}{8} l^2 \frac{dl}{dt}$$

$$\text{Therefore, } 1 = \frac{\sqrt{3}\pi}{8} 16 \cdot \frac{dl}{dt}$$

$$\Rightarrow \frac{dl}{dt} = \frac{1}{2\sqrt{3}\pi} \text{ cm/s.}$$

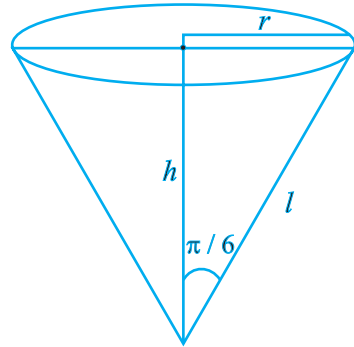

Fig. 6.2

Therefore, the rate of decrease of slant height = $\frac{1}{2\sqrt{3}\pi}$ cm/s.

Example 12 Find the equation of all the tangents to the curve $y = \cos(x + y)$, $-2\pi \leq x \leq 2\pi$, that are parallel to the line $x + 2y = 0$.

Solution Given that $y = \cos(x + y) \Rightarrow \frac{dy}{dx} = -\sin(x + y) \left[1 + \frac{dy}{dx} \right]$... (i)

or
$$\frac{dy}{dx} = -\frac{\sin(x + y)}{1 + \sin(x + y)}$$

Since tangent is parallel to $x + 2y = 0$, therefore slope of tangent = $-\frac{1}{2}$

$$\text{Therefore, } -\frac{\sin(x + y)}{1 + \sin(x + y)} = -\frac{1}{2} \Rightarrow \sin(x + y) = 1 \quad \dots \text{ (ii)}$$

Since $\cos(x + y) = y$ and $\sin(x + y) = 1 \Rightarrow \cos^2(x + y) + \sin^2(x + y) = y^2 + 1$

$$\Rightarrow 1 = y^2 + 1 \text{ or } y = 0.$$

Therefore, $\cos x = 0$.

$$\text{Therefore, } x = (2n + 1)\frac{\pi}{2}, \quad n = 0, \pm 1, \pm 2 \dots$$

Thus, $x = \pm \frac{\pi}{2}, \pm \frac{3\pi}{2}$, but $x = \frac{\pi}{2}, x = \frac{-3\pi}{2}$ satisfy equation (ii)

Hence, the points are $\left(\frac{\pi}{2}, 0\right), \left(\frac{-3\pi}{2}, 0\right)$.

Therefore, equation of tangent at $\left(\frac{\pi}{2}, 0\right)$ is $y = -\frac{1}{2}\left(x - \frac{\pi}{2}\right)$ or $2x + 4y - \pi = 0$, and

equation of tangent at $\left(\frac{-3\pi}{2}, 0\right)$ is $y = -\frac{1}{2}\left(x + \frac{3\pi}{2}\right)$ or $2x + 4y + 3\pi = 0$.

Example 13 Find the angle of intersection of the curves $y^2 = 4ax$ and $x^2 = 4by$.

Solution Given that $y^2 = 4ax \dots$ (i) and $x^2 = 4by \dots$ (ii). Solving (i) and (ii), we get

$$\left(\frac{x^2}{4b}\right)^2 = 4ax \Rightarrow x^4 = 64 ab^2 x$$

$$\text{or } x(x^3 - 64 ab^2) = 0 \Rightarrow x = 0, x = 4a^{\frac{1}{3}} b^{\frac{2}{3}}$$

Therefore, the points of intersection are $(0, 0)$ and $\left(4a^{\frac{1}{3}} b^{\frac{2}{3}}, 4a^{\frac{2}{3}} b^{\frac{1}{3}}\right)$.

$$\text{Again, } y^2 = 4ax \Rightarrow \frac{dy}{dx} = \frac{4a}{2y} = \frac{2a}{y} \text{ and } x^2 = 4by \Rightarrow \frac{dy}{dx} = \frac{2x}{4b} = \frac{x}{2b}$$

Therefore, at $(0, 0)$ the tangent to the curve $y^2 = 4ax$ is parallel to y -axis and tangent to the curve $x^2 = 4by$ is parallel to x -axis.

$$\Rightarrow \text{Angle between curves} = \frac{\pi}{2}$$

$$\text{At } \left(4a^{\frac{1}{3}} b^{\frac{2}{3}}, 4a^{\frac{2}{3}} b^{\frac{1}{3}}\right), m_1 \text{ (slope of the tangent to the curve (i))} = 2 \left(\frac{a}{b}\right)^{\frac{1}{3}}$$

$$= \frac{2a}{\frac{2}{2} \frac{1}{b}} = \frac{1}{2} \left(\frac{a}{b}\right)^{\frac{1}{3}}, m_2 \text{ (slope of the tangent to the curve (ii))} = \frac{4a^{\frac{1}{3}} b^{\frac{2}{3}}}{2b} = 2 \left(\frac{a}{b}\right)^{\frac{1}{3}}$$

$$\text{Therefore, } \tan \theta = \frac{\left| \frac{m_2 - m_1}{1 + m_1 m_2} \right|}{\left| \frac{2\left(\frac{a}{b}\right)^{\frac{1}{3}} - \frac{1}{2}\left(\frac{a}{b}\right)^{\frac{1}{3}}}{1 + 2\left(\frac{a}{b}\right)^{\frac{1}{3}} \frac{1}{2}\left(\frac{a}{b}\right)^{\frac{1}{3}}} \right|} = \frac{3a^{\frac{1}{3}} \cdot b^{\frac{1}{3}}}{2\left(a^{\frac{2}{3}} + b^{\frac{2}{3}}\right)}$$

$$\text{Hence, } \theta = \tan^{-1} \left(\frac{3a^{\frac{1}{3}} \cdot b^{\frac{1}{3}}}{2\left(a^{\frac{2}{3}} + b^{\frac{2}{3}}\right)} \right)$$

Example 14 Show that the equation of normal at any point on the curve $x = 3\cos \theta - \cos^3 \theta$, $y = 3\sin \theta - \sin^3 \theta$ is $4(y \cos^3 \theta - x \sin^3 \theta) = 3 \sin 4\theta$.

Solution We have $x = 3\cos \theta - \cos^3 \theta$

$$\text{Therefore, } \frac{dx}{d\theta} = -3\sin \theta + 3\cos^2 \theta \sin \theta = -3\sin \theta (1 - \cos^2 \theta) = -3\sin^3 \theta .$$

$$\frac{dy}{d\theta} = 3\cos \theta - 3\sin^2 \theta \cos \theta = 3\cos \theta (1 - \sin^2 \theta) = 3\cos^3 \theta$$

$$\frac{dy}{dx} = -\frac{\cos^3 \theta}{\sin^3 \theta} . \text{ Therefore, slope of normal} = +\frac{\sin^3 \theta}{\cos^3 \theta}$$

Hence the equation of normal is

$$y - (3\sin \theta - \sin^3 \theta) = \frac{\sin^3 \theta}{\cos^3 \theta} [x - (3\cos \theta - \cos^3 \theta)]$$

$$\Rightarrow y \cos^3 \theta - 3\sin \theta \cos^3 \theta + \sin^3 \theta \cos^3 \theta = x \sin^3 \theta - 3\sin^3 \theta \cos \theta + \sin^3 \theta \cos^3 \theta$$

$$\Rightarrow y \cos^3 \theta - x \sin^3 \theta = 3\sin \theta \cos \theta (\cos^2 \theta - \sin^2 \theta)$$

$$= \frac{3}{2} \sin 2\theta \cdot \cos 2\theta$$

$$= \frac{3}{4} \sin 4\theta$$

or $4(y \cos^3 \theta - x \sin^3 \theta) = 3 \sin 4\theta$.

Example 15 Find the maximum and minimum values of

$$f(x) = \sec x + \log \cos^2 x, \quad 0 < x < 2\pi$$

Solution $f(x) = \sec x + 2 \log \cos x$

Therefore, $f'(x) = \sec x \tan x - 2 \tan x = \tan x (\sec x - 2)$

$$f'(x) = 0 \Rightarrow \tan x = 0 \text{ or } \sec x = 2 \text{ or } \cos x = \frac{1}{2}$$

Therefore, possible values of x are $x = 0$, or $x = \pi$ and

$$x = \frac{\pi}{3} \quad \text{or} \quad x = \frac{5\pi}{3}$$

Again, $f''(x) = \sec^2 x (\sec x - 2) + \tan x (\sec x \tan x)$

$$= \sec^3 x + \sec x \tan^2 x - 2\sec^2 x$$

$$= \sec x (\sec^2 x + \tan^2 x - 2\sec x). \text{ We note that}$$

$f''(0) = 1(1 + 0 - 2) = -1 < 0$. Therefore, $x = 0$ is a point of maxima.

$f''(\pi) = -1(1 + 0 + 2) = -3 < 0$. Therefore, $x = \pi$ is a point of maxima.

$f''\left(\frac{\pi}{3}\right) = 2(4 + 3 - 4) = 6 > 0$. Therefore, $x = \frac{\pi}{3}$ is a point of minima.

$f''\left(\frac{5\pi}{3}\right) = 2(4 + 3 - 4) = 6 > 0$. Therefore, $x = \frac{5\pi}{3}$ is a point of minima.

Maximum Value of y at $x = 0$ is $1 + 0 = 1$

Maximum Value of y at $x = \pi$ is $-1 + 0 = -1$

Minimum Value of y at $x = \frac{\pi}{3}$ is $2 + 2 \log \frac{1}{2} = 2(1 - \log 2)$

Minimum Value of y at $x = \frac{5\pi}{3}$ is $2 + 2 \log \frac{1}{2} = 2(1 - \log 2)$

Example 16 Find the area of greatest rectangle that can be inscribed in an ellipse

$$\frac{x^2}{a^2} + \frac{y^2}{b^2} = 1.$$

Solution Let ABCD be the rectangle of maximum area with sides $AB = 2x$ and $BC = 2y$, where $C(x, y)$ is a point on the ellipse $\frac{x^2}{a^2} + \frac{y^2}{b^2} = 1$ as shown in the Fig. 6.3.

The area A of the rectangle is $4xy$ i.e. $A = 4xy$ which gives $A^2 = 16x^2y^2 = s$ (say)

$$\text{Therefore, } s = 16x^2 \left(1 - \frac{x^2}{a^2}\right) \cdot b^2 = \frac{16b^2}{a^2} (a^2x^2 - x^4)$$

$$\Rightarrow \frac{ds}{dx} = \frac{16b^2}{a^2} \cdot [2a^2x - 4x^3].$$

$$\text{Again, } \frac{ds}{dx} = 0 \Rightarrow x = \frac{a}{\sqrt{2}} \text{ and } y = \frac{b}{\sqrt{2}}$$

$$\text{Now, } \frac{d^2s}{dx^2} = \frac{16b^2}{a^2} [2a^2 - 12x^2]$$

$$\text{At } x = \frac{a}{\sqrt{2}}, \frac{d^2s}{dx^2} = \frac{16b^2}{a^2} [2a^2 - 6a^2] = \frac{16b^2}{a^2} (-4a^2) < 0$$

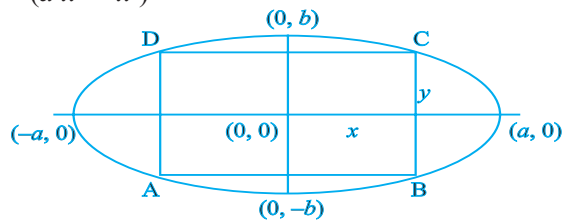

Fig. 6.3

Thus at $x = \frac{a}{\sqrt{2}}$, $y = \frac{b}{\sqrt{2}}$, s is maximum and hence the area A is maximum.

Maximum area = $4 \cdot x \cdot y = 4 \cdot \frac{a}{\sqrt{2}} \cdot \frac{b}{\sqrt{2}} = 2ab$ sq units.

Example 17 Find the difference between the greatest and least values of the function $f(x) = \sin 2x - x$, on $\left[-\frac{\pi}{2}, \frac{\pi}{2}\right]$.

Solution $f(x) = \sin 2x - x$

$$\Rightarrow f'(x) = 2 \cos 2x - 1$$

Therefore, $f'(x) = 0 \Rightarrow \cos 2x = \frac{1}{2} \Rightarrow 2x$ is $\frac{\pi}{3}$ or $\frac{5\pi}{3} \Rightarrow x = \frac{\pi}{6}$ or $-\frac{\pi}{6}$

$$f\left(-\frac{\pi}{2}\right) = \sin(-\pi) + \frac{\pi}{2} = \frac{\pi}{2}$$

$$f\left(-\frac{\pi}{6}\right) = \sin\left(-\frac{2\pi}{6}\right) + \frac{\pi}{6} = -\frac{\sqrt{3}}{2} + \frac{\pi}{6}$$

$$f\left(\frac{\pi}{6}\right) = \sin\left(\frac{2\pi}{6}\right) - \frac{\pi}{6} = \frac{\sqrt{3}}{2} - \frac{\pi}{6}$$

$$f\left(\frac{\pi}{2}\right) = \sin(\pi) - \frac{\pi}{2} = -\frac{\pi}{2}$$

Clearly, $\frac{\pi}{2}$ is the greatest value and $-\frac{\pi}{2}$ is the least.

Therefore, difference = $\frac{\pi}{2} + \frac{\pi}{2} = \pi$

Example 18 An isosceles triangle of vertical angle 2θ is inscribed in a circle of radius

a . Show that the area of triangle is maximum when $\theta = \frac{\pi}{6}$.

Solution Let ABC be an isosceles triangle inscribed in the circle with radius a such that $AB = AC$.

$AD = AO + OD = a + a \cos 2\theta$ and $BC = 2BD = 2a \sin 2\theta$ (see fig. 16.4)

Therefore, area of the triangle ABC i.e. $\Delta = \frac{1}{2} BC \cdot AD$

$$= \frac{1}{2} 2a \sin 2\theta \cdot (a + a \cos 2\theta)$$

$$= a^2 \sin 2\theta (1 + \cos 2\theta)$$

$$\Rightarrow \Delta = a^2 \sin 2\theta + \frac{1}{2} a^2 \sin 4\theta$$

$$\text{Therefore, } \frac{d\Delta}{d\theta} = 2a^2 \cos 2\theta + 2a^2 \cos 4\theta$$

$$= 2a^2 (\cos 2\theta + \cos 4\theta)$$

$$\frac{d\Delta}{d\theta} = 0 \Rightarrow \cos 2\theta = -\cos 4\theta = \cos (\pi - 4\theta)$$

$$\text{Therefore, } 2\theta = \pi - 4\theta \Rightarrow \theta = \frac{\pi}{6}$$

$$\frac{d^2\Delta}{d\theta^2} = 2a^2 (-2\sin 2\theta - 4\sin 4\theta) < 0 \text{ (at } \theta = \frac{\pi}{6} \text{)}.$$

Therefore, Area of triangle is maximum when $\theta = \frac{\pi}{6}$.

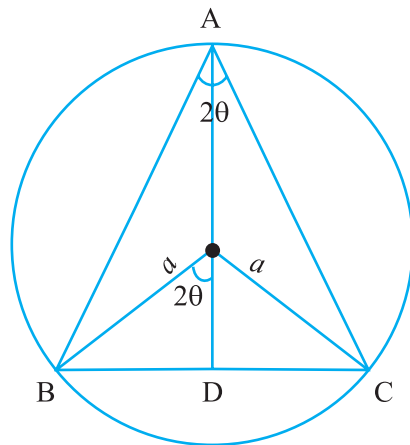

Fig. 6.4

Objective Type Questions

Choose the correct answer from the given four options in each of the following Examples 19 to 23.

Example 19 The abscissa of the point on the curve $3y = 6x - 5x^3$, the normal at which passes through origin is:

- (A) 1 (B) $\frac{1}{3}$ (C) 2 (D) $\frac{1}{2}$

Solution Let (x_1, y_1) be the point on the given curve $3y = 6x - 5x^3$ at which the normal passes through the origin. Then we have $\left(\frac{dy}{dx}\right)_{(x_1, y_1)} = 2 - 5x_1^2$. Again the equation of

the normal at (x_1, y_1) passing through the origin gives $2 - 5x_1^2 = \frac{-x_1}{y_1} = \frac{-3}{6 - 5x_1^2}$.

Since $x_1 = 1$ satisfies the equation, therefore, Correct answer is (A).

Example 20 The two curves $x^3 - 3xy^2 + 2 = 0$ and $3x^2y - y^3 = 2$

- (A) touch each other (B) cut at right angle
(C) cut at an angle $\frac{\pi}{3}$ (D) cut at an angle $\frac{\pi}{4}$

Solution From first equation of the curve, we have $3x^2 - 3y^2 - 6xy \frac{dy}{dx} = 0$

$\Rightarrow \frac{dy}{dx} = \frac{x^2 - y^2}{2xy} = (m_1)$ say and second equation of the curve gives

$$6xy + 3x^2 \frac{dy}{dx} - 3y^2 \frac{dy}{dx} = 0 \quad \Rightarrow \quad \frac{dy}{dx} = \frac{-2xy}{x^2 - y^2} = (m_2) \text{ say}$$

Since $m_1 \cdot m_2 = -1$. Therefore, correct answer is (B).

Example 21 The tangent to the curve given by $x = e^t \cdot \cos t$, $y = e^t \cdot \sin t$ at $t = \frac{\pi}{4}$ makes with x -axis an angle:

- (A) 0 (B) $\frac{\pi}{4}$ (C) $\frac{\pi}{3}$ (D) $\frac{\pi}{2}$

Solution $\frac{dx}{dt} = -e^t \cdot \sin t + e^t \cos t$, $\frac{dy}{dt} = e^t \cos t + e^t \sin t$

Therefore, $\left(\frac{dy}{dx}\right)_{t=\frac{\pi}{4}} = \frac{\cos t + \sin t}{\cos t - \sin t} = \frac{\sqrt{2}}{0}$ and hence the correct answer is (D).

Example 22 The equation of the normal to the curve $y = \sin x$ at $(0, 0)$ is:

- (A) $x = 0$ (B) $y = 0$ (C) $x + y = 0$ (D) $x - y = 0$

Solution $\frac{dy}{dx} = \cos x$. Therefore, slope of normal = $\left(\frac{-1}{\cos x}\right)_{x=0} = -1$. Hence the equation of normal is $y - 0 = -1(x - 0)$ or $x + y = 0$

Therefore, correct answer is (C).

Example 23 The point on the curve $y^2 = x$, where the tangent makes an angle of $\frac{\pi}{4}$ with x -axis is

- (A) $\left(\frac{1}{2}, \frac{1}{4}\right)$ (B) $\left(\frac{1}{4}, \frac{1}{2}\right)$ (C) $(4, 2)$ (D) $(1, 1)$

Solution $\frac{dy}{dx} = \frac{1}{2y} = \tan \frac{\pi}{4} = 1 \Rightarrow y = \frac{1}{2} \Rightarrow x = \frac{1}{4}$

Therefore, correct answer is B.

Fill in the blanks in each of the following Examples 24 to 29.

Example 24 The values of a for which $y = x^2 + ax + 25$ touches the axis of x are _____.

Solution $\frac{dy}{dx} = 0 \Rightarrow 2x + a = 0$ i.e. $x = -\frac{a}{2}$,

Therefore, $\frac{a^2}{4} + a\left(-\frac{a}{2}\right) + 25 = 0 \Rightarrow a = \pm 10$

Hence, the values of a are ± 10 .

Example 25 If $f(x) = \frac{1}{4x^2 + 2x + 1}$, then its maximum value is _____.

Solution For f to be maximum, $4x^2 + 2x + 1$ should be minimum i.e.

$4x^2 + 2x + 1 = 4\left(x + \frac{1}{4}\right)^2 + \left(1 - \frac{1}{4}\right)$ giving the minimum value of $4x^2 + 2x + 1 = \frac{3}{4}$.

Hence maximum value of $f = \frac{4}{3}$.

Example 26 Let f have second derivative at c such that $f'(c) = 0$ and $f''(c) > 0$, then c is a point of _____.

Solution Local minima.

Example 27 Minimum value of f if $f(x) = \sin x$ in $\left[-\frac{\pi}{2}, \frac{\pi}{2}\right]$ is _____.

Solution -1

Example 28 The maximum value of $\sin x + \cos x$ is _____.

Solution $\sqrt{2}$.

Example 29 The rate of change of volume of a sphere with respect to its surface area, when the radius is 2 cm, is _____.

Solution $1 \text{ cm}^3/\text{cm}^2$

$$v = \frac{4}{3}\pi r^3 \Rightarrow \frac{dv}{dr} = 4\pi r^2, \quad s = 4\pi r^2 \Rightarrow \frac{ds}{dr} = 8\pi r \Rightarrow \frac{dv}{ds} = \frac{r}{2} = 1 \text{ at } r = 2.$$

6.3 EXERCISE

Short Answer (S.A.)

1. A spherical ball of salt is dissolving in water in such a manner that the rate of decrease of the volume at any instant is proportional to the surface. Prove that the radius is decreasing at a constant rate.
2. If the area of a circle increases at a uniform rate, then prove that perimeter varies inversely as the radius.
3. A kite is moving horizontally at a height of 151.5 meters. If the speed of kite is 10 m/s, how fast is the string being let out; when the kite is 250 m away from the boy who is flying the kite? The height of boy is 1.5 m.
4. Two men A and B start with velocities v at the same time from the junction of two roads inclined at 45° to each other. If they travel by different roads, find the rate at which they are being separated.
5. Find an angle θ , $0 < \theta < \frac{\pi}{2}$, which increases twice as fast as its sine.
6. Find the approximate value of $(1.999)^5$.
7. Find the approximate volume of metal in a hollow spherical shell whose internal and external radii are 3 cm and 3.0005 cm, respectively.
8. A man, 2m tall, walks at the rate of $1\frac{2}{3}$ m/s towards a street light which is $5\frac{1}{3}$ m above the ground. At what rate is the tip of his shadow moving? At what

rate is the length of the shadow changing when he is $3\frac{1}{3}$ m from the base of the light?

9. A swimming pool is to be drained for cleaning. If L represents the number of litres of water in the pool t seconds after the pool has been plugged off to drain and $L = 200(10 - t)^2$. How fast is the water running out at the end of 5 seconds? What is the average rate at which the water flows out during the first 5 seconds?
10. The volume of a cube increases at a constant rate. Prove that the increase in its surface area varies inversely as the length of the side.
11. x and y are the sides of two squares such that $y = x - x^2$. Find the rate of change of the area of second square with respect to the area of first square.
12. Find the condition that the curves $2x = y^2$ and $2xy = k$ intersect orthogonally.
13. Prove that the curves $xy = 4$ and $x^2 + y^2 = 8$ touch each other.
14. Find the co-ordinates of the point on the curve $\sqrt{x} + \sqrt{y} = 4$ at which tangent is equally inclined to the axes.
15. Find the angle of intersection of the curves $y = 4 - x^2$ and $y = x^2$.
16. Prove that the curves $y^2 = 4x$ and $x^2 + y^2 - 6x + 1 = 0$ touch each other at the point $(1, 2)$.
17. Find the equation of the normal lines to the curve $3x^2 - y^2 = 8$ which are parallel to the line $x + 3y = 4$.
18. At what points on the curve $x^2 + y^2 - 2x - 4y + 1 = 0$, the tangents are parallel to the y -axis?
19. Show that the line $\frac{x}{a} + \frac{y}{b} = 1$, touches the curve $y = b \cdot e^{\frac{-x}{a}}$ at the point where the curve intersects the axis of y .
20. Show that $f(x) = 2x + \cot^{-1}x + \log(\sqrt{1+x^2} - x)$ is increasing in \mathbf{R} .

21. Show that for $a > 1$, $f(x) = \sqrt{3} \sin x - \cos x - 2ax + b$ is decreasing in \mathbf{R} .
22. Show that $f(x) = \tan^{-1}(\sin x + \cos x)$ is an increasing function in $0, \frac{\pi}{4}$.
23. At what point, the slope of the curve $y = -x^3 + 3x^2 + 9x - 27$ is maximum? Also find the maximum slope.
24. Prove that $f(x) = \sin x + \sqrt{3} \cos x$ has maximum value at $x = \frac{\pi}{6}$.

Long Answer (L.A.)

25. If the sum of the lengths of the hypotenuse and a side of a right angled triangle is given, show that the area of the triangle is maximum when the angle between them is $\frac{\pi}{3}$.
26. Find the points of local maxima, local minima and the points of inflection of the function $f(x) = x^5 - 5x^4 + 5x^3 - 1$. Also find the corresponding local maximum and local minimum values.
27. A telephone company in a town has 500 subscribers on its list and collects fixed charges of Rs 300/- per subscriber per year. The company proposes to increase the annual subscription and it is believed that for every increase of Re 1/- one subscriber will discontinue the service. Find what increase will bring maximum profit?
28. If the straight line $x \cos \alpha + y \sin \alpha = p$ touches the curve $\frac{x^2}{a^2} - \frac{y^2}{b^2} = 1$, then prove that $a^2 \cos^2 \alpha + b^2 \sin^2 \alpha = p^2$.
29. An open box with square base is to be made of a given quantity of card board of area c^2 . Show that the maximum volume of the box is $\frac{c^3}{6\sqrt{3}}$ cubic units.
30. Find the dimensions of the rectangle of perimeter 36 cm which will sweep out a volume as large as possible, when revolved about one of its sides. Also find the maximum volume.

- 31.** If the sum of the surface areas of cube and a sphere is constant, what is the ratio of an edge of the cube to the diameter of the sphere, when the sum of their volumes is minimum?
- 32.** AB is a diameter of a circle and C is any point on the circle. Show that the area of ΔABC is maximum, when it is isosceles.
- 33.** A metal box with a square base and vertical sides is to contain 1024 cm^3 . The material for the top and bottom costs Rs $5/\text{cm}^2$ and the material for the sides costs Rs $2.50/\text{cm}^2$. Find the least cost of the box.
- 34.** The sum of the surface areas of a rectangular parallelepiped with sides x , $2x$ and $\frac{x}{3}$ and a sphere is given to be constant. Prove that the sum of their volumes is minimum, if x is equal to three times the radius of the sphere. Also find the minimum value of the sum of their volumes.

Objective Type Questions

Choose the correct answer from the given four options in each of the following questions 35 to 39:

- 35.** The sides of an equilateral triangle are increasing at the rate of 2 cm/sec . The rate at which the area increases, when side is 10 cm is:
- (A) $10 \text{ cm}^2/\text{s}$ (B) $\sqrt{3} \text{ cm}^2/\text{s}$ (C) $10\sqrt{3} \text{ cm}^2/\text{s}$ (D) $\frac{10}{3} \text{ cm}^2/\text{s}$
- 36.** A ladder, 5 meter long, standing on a horizontal floor, leans against a vertical wall. If the top of the ladder slides downwards at the rate of 10 cm/sec , then the rate at which the angle between the floor and the ladder is decreasing when lower end of ladder is 2 metres from the wall is:
- (A) $\frac{1}{10} \text{ radian/sec}$ (B) $\frac{1}{20} \text{ radian/sec}$ (C) 20 radian/sec
 (D) 10 radian/sec
- 37.** The curve $y = x^{\frac{1}{5}}$ has at $(0, 0)$

- (A) a vertical tangent (parallel to y -axis)
 (B) a horizontal tangent (parallel to x -axis)
 (C) an oblique tangent
 (D) no tangent
- 38.** The equation of normal to the curve $3x^2 - y^2 = 8$ which is parallel to the line $x + 3y = 8$ is
 (A) $3x - y = 8$ (B) $3x + y + 8 = 0$
 (C) $x + 3y - 8 = 0$ (D) $x + 3y = 0$
- 39.** If the curve $ay + x^2 = 7$ and $x^3 = y$, cut orthogonally at $(1, 1)$, then the value of a is:
 (A) 1 (B) 0 (C) -6 (D) $.6$
- 40.** If $y = x^4 - 10$ and if x changes from 2 to 1.99, what is the change in y
 (A) $.32$ (B) $.032$ (C) 5.68 (D) 5.968
- 41.** The equation of tangent to the curve $y(1 + x^2) = 2 - x$, where it crosses x -axis is:
 (A) $x + 5y = 2$ (B) $x - 5y = 2$
 (C) $5x - y = 2$ (D) $5x + y = 2$
- 42.** The points at which the tangents to the curve $y = x^3 - 12x + 18$ are parallel to x -axis are:
 (A) $(2, -2), (-2, -34)$ (B) $(2, 34), (-2, 0)$
 (C) $(0, 34), (-2, 0)$ (D) $(2, 2), (-2, 34)$
- 43.** The tangent to the curve $y = e^{2x}$ at the point $(0, 1)$ meets x -axis at:
 (A) $(0, 1)$ (B) $-\frac{1}{2}, 0$ (C) $(2, 0)$ (D) $(0, 2)$
- 44.** The slope of tangent to the curve $x = t^2 + 3t - 8, y = 2t^2 - 2t - 5$ at the point $(2, -1)$ is:

- (A) $\frac{22}{7}$ (B) $\frac{6}{7}$ (C) $\frac{-6}{7}$ (D) -6
45. The two curves $x^3 - 3xy^2 + 2 = 0$ and $3x^2y - y^3 - 2 = 0$ intersect at an angle of
- (A) $\frac{\pi}{4}$ (B) $\frac{\pi}{3}$ (C) $\frac{\pi}{2}$ (D) $\frac{\pi}{6}$
46. The interval on which the function $f(x) = 2x^3 + 9x^2 + 12x - 1$ is decreasing is:
- (A) $[-1, \infty)$ (B) $[-2, -1]$ (C) $(-\infty, -2]$ (D) $[-1, 1]$
47. Let the $f: \mathbf{R} \rightarrow \mathbf{R}$ be defined by $f(x) = 2x + \cos x$, then f :
- (A) has a minimum at $x = \pi$ (B) has a maximum, at $x = 0$
 (C) is a decreasing function (D) is an increasing function
48. $y = x(x - 3)^2$ decreases for the values of x given by :
- (A) $1 < x < 3$ (B) $x < 0$ (C) $x > 0$ (D) $0 < x < \frac{3}{2}$
49. The function $f(x) = 4 \sin^3 x - 6 \sin^2 x + 12 \sin x + 100$ is strictly
- (A) increasing in $\left(\pi, \frac{3\pi}{2}\right)$ (B) decreasing in $\left(\frac{\pi}{2}, \pi\right)$
 (C) decreasing in $\left[-\frac{\pi}{2}, \frac{\pi}{2}\right)$ (D) decreasing in $\left[0, \frac{\pi}{2}\right)$
50. Which of the following functions is decreasing on $\left[0, \frac{\pi}{2}\right)$
- (A) $\sin 2x$ (B) $\tan x$ (C) $\cos x$ (D) $\cos 3x$
51. The function $f(x) = \tan x - x$
- (A) always increases (B) always decreases
 (C) never increases (D) sometimes increases and sometimes decreases.

52. If x is real, the minimum value of $x^2 - 8x + 17$ is
 (A) -1 (B) 0 (C) 1 (D) 2
53. The smallest value of the polynomial $x^3 - 18x^2 + 96x$ in $[0, 9]$ is
 (A) 126 (B) 0 (C) 135 (D) 160
54. The function $f(x) = 2x^3 - 3x^2 - 12x + 4$, has
 (A) two points of local maximum (B) two points of local minimum
 (C) one maxima and one minima (D) no maxima or minima
55. The maximum value of $\sin x \cdot \cos x$ is
 (A) $\frac{1}{4}$ (B) $\frac{1}{2}$ (C) $\sqrt{2}$ (D) $2\sqrt{2}$
56. At $x = \frac{5}{6}$, $f(x) = 2 \sin 3x + 3 \cos 3x$ is:
 (A) maximum (B) minimum
 (C) zero (D) neither maximum nor minimum.
57. Maximum slope of the curve $y = -x^3 + 3x^2 + 9x - 27$ is:
 (A) 0 (B) 12 (C) 16 (D) 32
58. $f(x) = x^x$ has a stationary point at
 (A) $x = e$ (B) $x = \frac{1}{e}$ (C) $x = 1$ (D) $x = \sqrt{e}$
59. The maximum value of $\frac{1}{x}^x$ is:
 (A) e (B) e^e (C) $\frac{1}{e^e}$ (D) $\frac{1}{e}^{\frac{1}{e}}$

Fill in the blanks in each of the following Exercises 60 to 64:

- 60.** The curves $y = 4x^2 + 2x - 8$ and $y = x^3 - x + 13$ touch each other at the point _____.
- 61.** The equation of normal to the curve $y = \tan x$ at $(0, 0)$ is _____.
- 62.** The values of a for which the function $f(x) = \sin x - ax + b$ increases on \mathbf{R} are _____.
- 63.** The function $f(x) = \frac{2x^2 - 1}{x^4}$, $x > 0$, decreases in the interval _____.
- 64.** The least value of the function $f(x) = ax + \frac{b}{x}$ ($a > 0$, $b > 0$, $x > 0$) is _____.



INTEGRALS

7.1 Overview

7.1.1 Let $\frac{d}{dx} F(x) = f(x)$. Then, we write $\int f(x) dx = F(x) + C$. These integrals are called indefinite integrals or general integrals, C is called a constant of integration. All these integrals differ by a constant.

7.1.2 If two functions differ by a constant, they have the same derivative.

7.1.3 Geometrically, the statement $\int f(x) dx = F(x) + C = y$ (say) represents a family of curves. The different values of C correspond to different members of this family and these members can be obtained by shifting any one of the curves parallel to itself. Further, the tangents to the curves at the points of intersection of a line $x = a$ with the curves are parallel.

7.1.4 *Some properties of indefinite integrals*

- (i) The process of differentiation and integration are inverse of each other, i.e., $\frac{d}{dx} \int f(x) dx = f(x)$ and $\int f'(x) dx = f(x) + C$, where C is any arbitrary constant.
- (ii) Two indefinite integrals with the same derivative lead to the same family of curves and so they are equivalent. So if f and g are two functions such that $\frac{d}{dx} \int f(x) dx = \frac{d}{dx} \int g(x) dx$, then $\int f(x) dx$ and $\int g(x) dx$ are equivalent.
- (iii) The integral of the sum of two functions equals the sum of the integrals of the functions i.e., $\int (f(x) + g(x)) dx = \int f(x) dx + \int g(x) dx$.

(iv) A constant factor may be written either before or after the integral sign, i.e.,

$$\int a f(x) dx = a \int f(x) dx, \text{ where 'a' is a constant.}$$

(v) Properties (iii) and (iv) can be generalised to a finite number of functions f_1, f_2, \dots, f_n and the real numbers, k_1, k_2, \dots, k_n giving

$$\int (k_1 f_1(x) + k_2 f_2(x) + \dots + k_n f_n(x)) dx = k_1 \int f_1(x) dx + k_2 \int f_2(x) dx + \dots + k_n \int f_n(x) dx$$

7.1.5 Methods of integration

There are some methods or techniques for finding the integral where we can not directly select the antiderivative of function f by reducing them into standard forms. Some of these methods are based on

1. Integration by substitution
2. Integration using partial fractions
3. Integration by parts.

7.1.6 Definite integral

The definite integral is denoted by $\int_a^b f(x) dx$, where a is the lower limit of the integral and b is the upper limit of the integral. The definite integral is evaluated in the following two ways:

(i) The definite integral as the limit of the sum

(ii)
$$\int_a^b f(x) dx = F(b) - F(a), \text{ if F is an antiderivative of } f(x).$$

7.1.7 The definite integral as the limit of the sum

The definite integral $\int_a^b f(x) dx$ is the area bounded by the curve $y = f(x)$, the ordinates $x = a$, $x = b$ and the x -axis and given by

$$\int_a^b f(x) dx = (b - a) \lim_{n \rightarrow \infty} \frac{1}{n} [f(a) + f(a+h) + \dots + f(a+(n-1)h)]$$

or

$$\int_a^b f(x) dx = \lim_{h \rightarrow 0} h [f(a) + f(a+h) + \dots + f(a+(n-1)h)] ,$$

where $h = \frac{b-a}{n} \rightarrow 0$ as $n \rightarrow \infty$.

7.1.8 Fundamental Theorem of Calculus

(i) *Area function* : The function $A(x)$ denotes the area function and is given

$$\text{by } A(x) = \int_a^x f(x) dx .$$

(ii) *First Fundamental Theorem of integral Calculus*

Let f be a continuous function on the closed interval $[a, b]$ and let $A(x)$ be the area function . Then $A'(x) = f(x)$ for all $x \in [a, b]$.

(iii) *Second Fundamental Theorem of Integral Calculus*

Let f be continuous function defined on the closed interval $[a, b]$ and F be an antiderivative of f .

$$\int_a^b f(x) dx = [F(x)]_a^b = F(b) - F(a).$$

7.1.9 Some properties of Definite Integrals

$$P_0 : \int_a^b f(x) dx = \int_a^b f(t) dt$$

$$P_1 : \int_a^b f(x) dx = - \int_b^a f(x) dx , \text{ in particular, } \int_a^a f(x) dx = 0$$

$$P_2 : \int_a^b f(x) dx = \int_a^c f(x) dx + \int_c^b f(x) dx$$

$$P_3 : \int_a^b f(x) dx = \int_a^b f(a+b-x) dx$$

$$P_4 : \int_0^a f(x) dx = \int_0^a f(a-x) dx$$

$$P_5 : \int_0^{2a} f(x) dx = \int_0^a f(x) dx + \int_0^a f(2a-x) dx$$

$$P_6 : \int_0^{2a} f(x) dx = \begin{cases} 2 \int_0^a f(x) dx, & \text{if } f(2a-x) = f(x), \\ 0, & \text{if } f(2a-x) = -f(x). \end{cases}$$

$$P_7 : \text{(i) } \int_{-a}^a f(x) dx = 2 \int_0^a f(x) dx, \text{ if } f \text{ is an even function i.e., } f(-x) = f(x)$$

$$\text{(ii) } \int_{-a}^a f(x) dx = 0, \text{ if } f \text{ is an odd function i.e., } f(-x) = -f(x)$$

7.2 Solved Examples

Short Answer (S.A.)

Example 1 Integrate $\left(\frac{2a}{\sqrt{x}} - \frac{b}{x^2} + 3c\sqrt[3]{x^2}\right)$ w.r.t. x

Solution $\int \left(\frac{2a}{\sqrt{x}} - \frac{b}{x^2} + 3c\sqrt[3]{x^2}\right) dx$

$$= \int 2a(x)^{-\frac{1}{2}} dx - \int bx^{-2} dx + \int 3cx^{\frac{2}{3}} dx$$

$$= 4a\sqrt{x} + \frac{b}{x} + \frac{9cx^{\frac{5}{3}}}{5} + C .$$

Example 2 Evaluate $\int \frac{3ax}{b^2 + c^2x^2} dx$

Solution Let $v = b^2 + c^2x^2$, then $dv = 2c^2 x dx$

$$\begin{aligned} \text{Therefore, } \int \frac{3ax}{b^2 + c^2x^2} dx &= \frac{3a}{2c^2} \frac{dv}{v} \\ &= \frac{3a}{2c^2} \log|b^2 + c^2x^2| + C. \end{aligned}$$

Example 3 Verify the following using the concept of integration as an antiderivative.

$$\int \frac{x^3 dx}{x^2 + 1} = x - \frac{x^2}{2} + \frac{x^3}{3} - \log|x^2 + 1| + C$$

Solution $\frac{d}{dx} \left(x - \frac{x^2}{2} + \frac{x^3}{3} - \log|x^2 + 1| \right) = C$

$$= 1 - \frac{2x}{2} + \frac{3x^2}{3} - \frac{1}{x^2 + 1}$$

$$= 1 - x + x^2 - \frac{1}{x^2 + 1} = \frac{x^3}{x^2 + 1}.$$

Thus $\int \left(x - \frac{x^2}{2} + \frac{x^3}{3} - \log|x^2 + 1| + C \right) dx = \int \frac{x^3}{x^2 + 1} dx$

Example 4 Evaluate $\int \frac{1}{\sqrt{1-x^2}} dx$, $x \neq \pm 1$.

Solution Let $I = \int \frac{1}{\sqrt{1-x^2}} dx = \int \frac{1}{\sqrt{1-x^2}} dx + \int \frac{x dx}{\sqrt{1-x^2}} = \sin^{-1} x + I_1,$

where $I_1 = \frac{x dx}{\sqrt{1-x^2}}$.

Put $1 - x^2 = t^2 \Rightarrow -2x dx = 2t dt$. Therefore

$$I_1 = - \int dt = -t + C = -\sqrt{1-x^2} + C$$

Hence $I = \sin^{-1}x - \sqrt{1-x^2} + C$.

Example 5 Evaluate $\int \frac{dx}{\sqrt{(x-\alpha)(\beta-x)}}$, $\beta > \alpha$

Solution Put $x - \alpha = t^2$. Then $x = \alpha + t^2$, $dx = 2t dt$ and $\beta - x = \beta - \alpha - t^2$. Now

$$\begin{aligned} I &= \int \frac{2t dt}{\sqrt{t^2(\beta - \alpha - t^2)}} = \int \frac{2 dt}{\sqrt{(\beta - \alpha - t^2)}} \\ &= 2 \int \frac{dt}{\sqrt{k^2 - t^2}}, \text{ where } k^2 = \beta - \alpha \\ &= 2 \sin^{-1} \frac{t}{k} + C = 2 \sin^{-1} \sqrt{\frac{x - \alpha}{\beta - \alpha}} + C. \end{aligned}$$

Example 6 Evaluate $\int \tan^8 x \sec^4 x dx$

Solution $I = \int \tan^8 x \sec^4 x dx$

$$= \int \tan^8 x (\sec^2 x) \sec^2 x dx$$

$$= \int \tan^8 x (\tan^2 x + 1) \sec^2 x dx$$

$$\begin{aligned}
 &= \int \tan^{10} x \sec^2 x dx + \int \tan^8 x \sec^2 x dx \\
 &= \frac{\tan^{11} x}{11} + \frac{\tan^9 x}{9} + C.
 \end{aligned}$$

Example 7 Find $\int \frac{x^3}{x^4 + 3x^2 + 2} dx$

Solution Put $x^2 = t$. Then $2x dx = dt$.

$$\text{Now } I = \int \frac{x^3 dx}{x^4 + 3x^2 + 2} = \frac{1}{2} \int \frac{t dt}{t^2 + 3t + 2}$$

$$\text{Consider } \frac{t}{t^2 + 3t + 2} = \frac{A}{t+1} + \frac{B}{t+2}$$

Comparing coefficient, we get $A = -1$, $B = 2$.

$$\begin{aligned}
 \text{Then } I &= \frac{1}{2} \left[2 \int \frac{dt}{t+2} - \int \frac{dt}{t+1} \right] \\
 &= \frac{1}{2} [2 \log|t+2| - \log|t+1|] \\
 &= \log \left| \frac{x^2 + 2}{\sqrt{x^2 + 1}} \right| + C
 \end{aligned}$$

Example 8 Find $\int \frac{dx}{2\sin^2 x + 5\cos^2 x}$

Solution Dividing numerator and denominator by $\cos^2 x$, we have

$$I = \frac{\sec^2 x dx}{2\tan^2 x + 5}$$

Put $\tan x = t$ so that $\sec^2 x \, dx = dt$. Then

$$\begin{aligned} I &= \int \frac{dt}{2t^2 + 5} = \frac{1}{2} \int \frac{dt}{t^2 + \left(\sqrt{\frac{5}{2}}\right)^2} \\ &= \frac{1}{2} \frac{\sqrt{2}}{\sqrt{5}} \tan^{-1} \left(\frac{\sqrt{2}t}{\sqrt{5}} \right) + C \\ &= \frac{1}{\sqrt{10}} \tan^{-1} \left(\frac{\sqrt{2} \tan x}{\sqrt{5}} \right) + C. \end{aligned}$$

Example 9 Evaluate $\int_{-1}^2 (7x-5) \, dx$ as a limit of sums.

Solution Here $a = -1$, $b = 2$, and $h = \frac{2+1}{n}$, i.e., $nh = 3$ and $f(x) = 7x - 5$.

Now, we have

$$\int_{-1}^2 (7x-5) \, dx = \lim_{h \rightarrow 0} h \left[f(-1) + f(-1+h) + f(-1+2h) + \dots + f(-1+(n-1)h) \right]$$

Note that

$$f(-1) = -7 - 5 = -12$$

$$f(-1+h) = -7 + 7h - 5 = -12 + 7h$$

$$f(-1+(n-1)h) = 7(n-1)h - 12.$$

Therefore,

$$\begin{aligned} \int_{-1}^2 (7x-5) \, dx &= \lim_{h \rightarrow 0} h \left[(-12) + (7h-12) + (14h-12) + \dots + (7(n-1)h-12) \right] \\ &= \lim_{h \rightarrow 0} h \left[7h \left[1 + 2 + \dots + (n-1) \right] - 12n \right] \end{aligned}$$

$$\begin{aligned}
 &= \lim_{h \rightarrow 0} h \left[7h \frac{(n-1)n}{2} - .12n \right] = \lim_{h \rightarrow 0} \left[\frac{7}{2}(nh)(nh-h) - 12nh \right] \\
 &= \frac{7}{2} 3 \cdot 3 - 0 - 12 \cdot 3 = \frac{7 \times 9}{2} - 36 = \frac{-9}{2}.
 \end{aligned}$$

Example 10 Evaluate $\int_0^{\frac{\pi}{2}} \frac{\tan^7 x}{\cot^7 x + \tan^7 x} dx$

Solution We have

$$I = \int_0^{\frac{\pi}{2}} \frac{\tan^7 x}{\cot^7 x + \tan^7 x} dx \tag{1}$$

$$= \int_0^{\frac{\pi}{2}} \frac{\tan^7 \left(\frac{\pi}{2} - x \right)}{\cot^7 \left(\frac{\pi}{2} - x \right) + \tan^7 \left(\frac{\pi}{2} - x \right)} dx \tag{by (P_4)}$$

$$= \int_0^{\frac{\pi}{2}} \frac{\cot^7(x) dx}{\cot^7 x dx + \tan^7 x} \tag{2}$$

Adding (1) and (2), we get

$$2I = \int_0^{\frac{\pi}{2}} \left(\frac{\tan^7 x + \cot^7 x}{\tan^7 x + \cot^7 x} \right) dx$$

$$= \int_0^{\frac{\pi}{2}} dx \text{ which gives } I = \frac{\pi}{4}.$$

Example 11 Find $\int_2^8 \frac{\sqrt{10-x}}{\sqrt{x} + \sqrt{10-x}} dx$

Solution We have

$$I = \int_2^8 \frac{\sqrt{10-x}}{\sqrt{x} + \sqrt{10-x}} dx \quad \dots(1)$$

$$= \int_2^8 \frac{\sqrt{10-(10-x)}}{\sqrt{10-x} \sqrt{10-10-x}} dx \quad \text{by (P}_3\text{)}$$

$$\Rightarrow I = \int_2^8 \frac{\sqrt{x}}{\sqrt{10-x} + \sqrt{x}} dx \quad (2)$$

Adding (1) and (2), we get

$$2I = \int_2^8 1 dx = 8-2 = 6$$

Hence $I = 3$

Example 12 Find $\int_0^{\frac{\pi}{4}} \sqrt{1+\sin 2x} dx$

Solution We have

$$I = \int_0^{\frac{\pi}{4}} \sqrt{1+\sin 2x} dx = \int_0^{\frac{\pi}{4}} \sqrt{(\sin x + \cos x)^2} dx$$

$$= \int_0^{\frac{\pi}{4}} (\sin x + \cos x) dx$$

$$= (-\cos x + \sin x) \Big|_0^{\frac{\pi}{4}}$$

$$I = 1.$$

Example 13 Find $\int x^2 \tan^{-1} x \, dx$.

Solution $I = \int x^2 \tan^{-1} x \, dx$

$$= \tan^{-1} x \int x^2 \, dx - \int \frac{1}{1+x^2} \cdot \frac{x^3}{3} \, dx$$

$$= \frac{x^3}{3} \tan^{-1} x - \frac{1}{3} \int \left(x - \frac{x}{1+x^2} \right) dx$$

$$= \frac{x^3}{3} \tan^{-1} x - \frac{x^2}{6} + \frac{1}{6} \log|1+x^2| + C.$$

Example 14 Find $\int \sqrt{10-4x+4x^2} \, dx$

Solution We have

$$I = \int \sqrt{10-4x+4x^2} \, dx = \int \sqrt{(2x-1)^2 + 3^2} \, dx$$

Put $t = 2x - 1$, then $dt = 2dx$.

Therefore, $I = \frac{1}{2} \int \sqrt{t^2 + (3)^2} \, dt$

$$= \frac{1}{2} t \frac{\sqrt{t^2 + 9}}{2} + \frac{9}{4} \log|t + \sqrt{t^2 + 9}| + C$$

$$= \frac{1}{4} (2x-1) \sqrt{(2x-1)^2 + 9} + \frac{9}{4} \log|(2x-1) + \sqrt{(2x-1)^2 + 9}| + C.$$

Long Answer (L.A.)

Example 15 Evaluate $\int \frac{x^2 dx}{x^4 + x^2 - 2}$.

Solution Let $x^2 = t$. Then

$$\frac{x^2}{x^4 + x^2 - 2} = \frac{t}{t^2 + t - 2} = \frac{t}{(t+2)(t-1)} = \frac{A}{t+2} + \frac{B}{t-1}$$

So $t = A(t-1) + B(t+2)$

Comparing coefficients, we get $A = \frac{2}{3}$, $B = \frac{1}{3}$.

So
$$\frac{x^2}{x^4 + x^2 - 2} = \frac{2}{3} \frac{1}{x^2 + 2} + \frac{1}{3} \frac{1}{x^2 - 1}$$

Therefore,

$$\begin{aligned} \int \frac{x^2}{x^4 + x^2 - 2} dx &= \frac{2}{3} \int \frac{1}{x^2 + 2} dx + \frac{1}{3} \int \frac{dx}{x^2 - 1} \\ &= \frac{2}{3} \frac{1}{\sqrt{2}} \tan^{-1} \frac{x}{\sqrt{2}} + \frac{1}{6} \log \left| \frac{x-1}{x+1} \right| + C \end{aligned}$$

Example 16 Evaluate $\int \frac{x^3 x}{x^4 - 9} dx$

Solution We have

$$I = \int \frac{x^3 x}{x^4 - 9} dx = \int \frac{x^3}{x^4 - 9} dx = \int \frac{x dx}{x^4 - 9} = I_1 + I_2.$$

Now $I_1 = \int \frac{x^3}{x^4 - 9}$

Put $t = x^4 - 9$ so that $4x^3 dx = dt$. Therefore

$$I_1 = \frac{1}{4} \frac{dt}{t} = \frac{1}{4} \log|t| \quad C_1 = \frac{1}{4} \log|x^4 - 9| + C_1$$

Again, $I_2 = \frac{x dx}{x^4 - 9}$.

Put $x^2 = u$ so that $2x dx = du$. Then

$$\begin{aligned} I_2 &= \frac{1}{2} \frac{du}{u^2 - 3^2} = \frac{1}{2 \cdot 6} \log \left| \frac{u-3}{u+3} \right| + C_2 \\ &= \frac{1}{12} \log \left| \frac{x^2 - 3}{x^2 + 3} \right| + C_2. \end{aligned}$$

Thus $I = I_1 + I_2$

$$= \frac{1}{4} \log|x^4 - 9| + \frac{1}{12} \log \left| \frac{x^2 - 3}{x^2 + 3} \right| + C$$

Example 17 Show that $\int_0^{\frac{\pi}{2}} \frac{\sin^2 x}{\sin x + \cos x} = \frac{1}{\sqrt{2}} \log(\sqrt{2} + 1)$

Solution We have

$$I = \int_0^{\frac{\pi}{2}} \frac{\sin^2 x}{\sin x + \cos x} dx$$

$$= \int_0^{\frac{\pi}{2}} \frac{\sin^2\left(\frac{\pi}{2}-x\right)}{\sin\left(\frac{\pi}{2}-x\right) + \cos\left(\frac{\pi}{2}-x\right)} dx \quad (\text{by P4})$$

$$\Rightarrow I = \int_0^{\frac{\pi}{2}} \frac{\cos^2 x}{\sin x + \cos x} dx$$

$$\text{Thus, we get } 2I = \frac{1}{\sqrt{2}} \int_0^{\frac{\pi}{2}} \frac{dx}{\cos\left(x - \frac{\pi}{4}\right)}$$

$$= \frac{1}{\sqrt{2}} \int_0^{\frac{\pi}{2}} \sec\left(x - \frac{\pi}{4}\right) dx = \frac{1}{\sqrt{2}} \left[\log\left(\sec\left(x - \frac{\pi}{4}\right) + \tan\left(x - \frac{\pi}{4}\right)\right) \right]_0^{\frac{\pi}{2}}$$

$$= \frac{1}{\sqrt{2}} \left[\log\left(\sec\frac{\pi}{4} + \tan\frac{\pi}{4}\right) - \log\sec\left(-\frac{\pi}{4}\right) + \tan\left(-\frac{\pi}{4}\right) \right]$$

$$= \frac{1}{\sqrt{2}} \left[\log(\sqrt{2} + 1) - \log(\sqrt{2} - 1) \right] = \frac{1}{\sqrt{2}} \log \left| \frac{\sqrt{2} + 1}{\sqrt{2} - 1} \right|$$

$$= \frac{1}{\sqrt{2}} \log\left(\frac{(\sqrt{2} + 1)^2}{1}\right) = \frac{2}{\sqrt{2}} \log(\sqrt{2} + 1)$$

$$\text{Hence } I = \frac{1}{\sqrt{2}} \log(\sqrt{2} + 1).$$

Example 18 Find $\int_0^1 x(\tan^{-1} x)^2 dx$

Solution $I = \int_0^1 x(\tan^{-1} x)^2 dx$.

Integrating by parts, we have

$$\begin{aligned} I &= \frac{x^2}{2} \left[(\tan^{-1} x)^2 \right]_0^1 - \frac{1}{2} \int_0^1 x^2 \cdot 2 \frac{\tan^{-1} x}{1+x^2} dx \\ &= \frac{\pi^2}{32} - \int_0^1 \frac{x^2}{1+x^2} \cdot \tan^{-1} x dx \\ &= \frac{\pi^2}{32} - I_1, \text{ where } I_1 = \int_0^1 \frac{x^2}{1+x^2} \tan^{-1} x dx \end{aligned}$$

Now
$$\begin{aligned} I_1 &= \int_0^1 \frac{x^2 + 1 - 1}{1+x^2} \tan^{-1} x dx \\ &= \int_0^1 \tan^{-1} x dx - \int_0^1 \frac{1}{1+x^2} \tan^{-1} x dx \\ &= I_2 - \frac{1}{2} \left((\tan^{-1} x)^2 \right)_0^1 = I_2 - \frac{\pi^2}{32} \end{aligned}$$

Here
$$\begin{aligned} I_2 &= \int_0^1 \tan^{-1} x dx = (x \tan^{-1} x)_0^1 - \int_0^1 \frac{x}{1+x^2} dx \\ &= \frac{\pi}{4} - \frac{1}{2} \left(\log |1+x^2| \right)_0^1 = \frac{\pi}{4} - \frac{1}{2} \log 2. \end{aligned}$$

Thus
$$I_1 = \frac{\pi}{4} - \frac{1}{2} \log 2 - \frac{\pi^2}{32}$$

$$\begin{aligned} \text{Therefore, } I &= \frac{\pi^2}{32} - \frac{\pi}{4} + \frac{1}{2} \log 2 - \frac{\pi^2}{32} = \frac{\pi^2}{16} - \frac{\pi}{4} + \frac{1}{2} \log 2 \\ &= \frac{\pi^2 - 4\pi}{16} + \log \sqrt{2}. \end{aligned}$$

Example 19 Evaluate $\int_{-1}^2 f(x) dx$, where $f(x) = |x + 1| + |x| + |x - 1|$.

Solution We can redefine f as $f(x) = \begin{cases} 2 - x, & \text{if } -1 < x \leq 0 \\ x + 2, & \text{if } 0 < x \leq 1 \\ 3x, & \text{if } 1 < x \leq 2 \end{cases}$

$$\text{Therefore, } \int_{-1}^2 f(x) dx = \int_{-1}^0 (2 - x) dx + \int_0^1 (x + 2) dx + \int_1^2 3x dx \quad (\text{by } P_2)$$

$$\begin{aligned} &= \left(2x - \frac{x^2}{2} \right)_{-1}^0 + \left(\frac{x^2}{2} + 2x \right)_0^1 + \left(\frac{3x^2}{2} \right)_1^2 \\ &= 0 - \left(-2 - \frac{1}{2} \right) + \left(\frac{1}{2} + 2 \right) + 3 \left(\frac{4}{2} - \frac{1}{2} \right) = \frac{5}{2} + \frac{5}{2} + \frac{9}{2} = \frac{19}{2}. \end{aligned}$$

Objective Type Questions

Choose the correct answer from the given four options in each of the Examples from 20 to 30.

Example 20 $\int e^x (\cos x - \sin x) dx$ is equal to

(A) $e^x \cos x + C$

(B) $e^x \sin x + C$

(C) $-e^x \cos x + C$

(D) $-e^x \sin x + C$

Solution (A) is the correct answer since $\int e^x [f(x) + f'(x)] dx = e^x f(x) + C$. Here $f(x) = \cos x$, $f'(x) = -\sin x$.

Example 21 $\int \frac{dx}{\sin^2 x \cos^2 x}$ is equal to

(A) $\tan x + \cot x + C$

(B) $(\tan x + \cot x)^2 + C$

(C) $\tan x - \cot x + C$

(D) $(\tan x - \cot x)^2 + C$

Solution (C) is the correct answer, since

$$\begin{aligned} I &= \int \frac{dx}{\sin^2 x \cos^2 x} = \int \frac{(\sin^2 x + \cos^2 x) dx}{\sin^2 x \cos^2 x} \\ &= \int \sec^2 x dx + \int \operatorname{cosec}^2 x dx = \tan x - \cot x + C \end{aligned}$$

Example 22 If $\int \frac{3e^x - 5e^{-x}}{4e^x + 5e^{-x}} dx = ax + b \log |4e^x + 5e^{-x}| + C$, then

(A) $a = \frac{-1}{8}$, $b = \frac{7}{8}$

(B) $a = \frac{1}{8}$, $b = \frac{7}{8}$

(C) $a = \frac{-1}{8}$, $b = \frac{-7}{8}$

(D) $a = \frac{1}{8}$, $b = \frac{-7}{8}$

Solution (C) is the correct answer, since differentiating both sides, we have

$$\frac{3e^x - 5e^{-x}}{4e^x + 5e^{-x}} = a + b \frac{(4e^x - 5e^{-x})}{4e^x + 5e^{-x}},$$

giving $3e^x - 5e^{-x} = a(4e^x + 5e^{-x}) + b(4e^x - 5e^{-x})$. Comparing coefficients on both sides, we get $3 = 4a + 4b$ and $-5 = 5a - 5b$. This verifies $a = \frac{-1}{8}$, $b = \frac{7}{8}$.

Example 23 $\int_{a+c}^{b+c} f(x) dx$ is equal to

(A) $\int_a^b f(x-c) dx$

(B) $\int_a^b f(x+c) dx$

(C) $\int_a^b f(x) dx$

(D) $\int_{a-c}^{b-c} f(x) dx$

Solution (B) is the correct answer, since by putting $x = t + c$, we get

$$I = \int_a^b f(c+t) dt = \int_a^b f(x+c) dx$$

Example 24 If f and g are continuous functions in $[0, 1]$ satisfying $f(x) = f(a-x)$

and $g(x) + g(a-x) = a$, then $\int_0^a f(x) \cdot g(x) dx$ is equal to

(A) $\frac{a}{2}$

(B) $\frac{a}{2} \int_0^a f(x) dx$

(C) $\int_0^a f(x) dx$

(D) $a \int_0^a f(x) dx$

Solution B is the correct answer. Since $I = \int_0^a f(x) \cdot g(x) dx$

$$= \int_0^a f(a-x) g(a-x) dx = \int_0^a f(x) (a-g(x)) dx$$

$$= a \int_0^a f(x) dx - \int_0^a f(x) \cdot g(x) dx = a \int_0^a f(x) dx - I$$

or $I = \frac{a}{2} \int_0^a f(x) dx$.

Example 25 If $x = \int_0^y \frac{dt}{\sqrt{1+9t^2}}$ and $\frac{d^2y}{dx^2} = ay$, then a is equal to

- (A) 3 (B) 6 (C) 9 (D) 1

Solution (C) is the correct answer, since $x = \int_0^y \frac{dt}{\sqrt{1+9t^2}} \Rightarrow \frac{dx}{dy} = \frac{1}{\sqrt{1+9y^2}}$

which gives $\frac{d^2y}{dx^2} = \frac{18y}{2\sqrt{1+9y^2}} \cdot \frac{dy}{dx} = 9y$.

Example 26 $\int_{-1}^1 \frac{x^3 + |x| + 1}{x^2 + 2|x| + 1} dx$ is equal to

- (A) $\log 2$ (B) $2 \log 2$ (C) $\frac{1}{2} \log 2$ (D) $4 \log 2$

Solution (B) is the correct answer, since $I = \int_{-1}^1 \frac{x^3 + |x| + 1}{x^2 + 2|x| + 1} dx$

$$= \int_{-1}^1 \frac{x^3}{x^2 + 2|x| + 1} + \int_{-1}^1 \frac{|x| + 1}{x^2 + 2|x| + 1} dx = 0 + 2 \int_0^1 \frac{|x| + 1}{(|x| + 1)^2} dx$$

[odd function + even function]

$$= 2 \int_0^1 \frac{x+1}{(x+1)^2} dx = 2 \int_0^1 \frac{1}{x+1} dx = 2 |\log|x+1||_0^1 = 2 \log 2.$$

Example 27 If $\int_0^1 \frac{e^t}{1+t} dt = a$, then $\int_0^1 \frac{e^t}{(1+t)^2} dt$ is equal to

- (A) $a - 1 + \frac{e}{2}$ (B) $a + 1 - \frac{e}{2}$ (C) $a - 1 - \frac{e}{2}$ (D) $a + 1 + \frac{e}{2}$

Solution (B) is the correct answer, since $I = \int_0^1 \frac{e^t}{1+t} dt$

$$= \left| \frac{1}{1+t} e^t \right|_0^1 + \int_0^1 \frac{e^t}{(1+t)^2} dt = a \text{ (given)}$$

Therefore, $\int_0^1 \frac{e^t}{(1+t)^2} dt = a - \frac{e}{2} + 1$.

Example 28 $\int_{-2}^2 |x \cos \pi x| dx$ is equal to

- (A) $\frac{8}{\pi}$ (B) $\frac{4}{\pi}$ (C) $\frac{2}{\pi}$ (D) $\frac{1}{\pi}$

Solution (A) is the correct answer, since $I = \int_{-2}^2 |x \cos \pi x| dx = 2 \int_0^2 |x \cos \pi x| dx$

$$= 2 \left\{ \int_0^{\frac{1}{2}} |x \cos \pi x| dx + \int_{\frac{1}{2}}^{\frac{3}{2}} |x \cos \pi x| dx + \int_{\frac{3}{2}}^2 |x \cos \pi x| dx \right\} = \frac{8}{\pi}$$

Fill in the blanks in each of the Examples 29 to 32.

Example 29 $\int \frac{\sin^6 x}{\cos^8 x} dx = \underline{\hspace{2cm}}$.

Solution $\frac{\tan^7 x}{7} + C$

Example 30 $\int_{-a}^a f(x) dx = 0$ if f is an _____ function.

Solution Odd.

Example 31 $\int_0^{2a} f(x) dx = 2 \int_0^a f(x) dx$, if $f(2a-x) =$ _____.

Solution $f(x)$.

Example 32 $\int_0^{\frac{\pi}{2}} \frac{\sin^n x dx}{\sin^n x + \cos^n x} =$ _____.

Solution $\frac{\pi}{4}$.

7.3 EXERCISE

Short Answer (S.A.)

Verify the following :

1. $\int \frac{2x-1}{2x+3} dx = x - \log |(2x+3)^2| + C$

2. $\int \frac{2x+3}{x^2+3x} dx = \log |x^2+3x| + C$

Evaluate the following:

3. $\int \frac{(x^2+2)dx}{x+1}$

4. $\int \frac{e^{6 \log x} - e^{5 \log x}}{e^{4 \log x} - e^{3 \log x}} dx$

$$5. \int \frac{(1 + \cos x)}{x + \sin x} dx$$

$$7. \int \tan^2 x \sec^4 x dx$$

$$9. \int \sqrt{1 + \sin x} dx$$

$$10. \int \frac{x}{\sqrt{x+1}} dx \quad (\text{Hint : Put } \sqrt{x} = z)$$

$$12. \int \frac{x^{\frac{1}{2}}}{1+x^{\frac{3}{4}}} dx \quad (\text{Hint : Put } x = z^4)$$

$$14. \int \frac{dx}{\sqrt{16-9x^2}}$$

$$16. \int \frac{3x-1}{\sqrt{x^2+9}} dx$$

$$18. \int \frac{x}{x^4-1} dx$$

$$20. \int \sqrt{2ax-x^2} dx$$

$$22. \int \frac{(\cos 5x + \cos 4x)}{1-2\cos 3x} dx$$

$$6. \int \frac{dx}{1+\cos x}$$

$$8. \int \frac{\sin x + \cos x}{\sqrt{1 + \sin 2x}} dx$$

$$11. \int \sqrt{\frac{a+x}{a-x}}$$

$$13. \int \frac{\sqrt{1+x^2}}{x^4} dx$$

$$15. \int \frac{dt}{\sqrt{3t-2t^2}}$$

$$17. \int \sqrt{5-2x+x^2} dx$$

$$19. \int \frac{x^2}{1-x^4} dx \quad \text{put } x^2 = t$$

$$21. \int \frac{\sin^{-1} x}{(1-x^2)^{\frac{3}{2}}} dx$$

$$23. \int \frac{\sin^6 x + \cos^6 x}{\sin^2 x \cos^2 x} dx$$

$$24. \int \frac{\sqrt{x}}{\sqrt{a^3 - x^3}} dx$$

$$25. \int \frac{\cos x - \cos 2x}{1 - \cos x} dx$$

$$26. \int \frac{dx}{x\sqrt{x^4 - 1}} \quad (\text{Hint : Put } x^2 = \sec \theta)$$

Evaluate the following as limit of sums:

$$27. \int_0^2 (x^2 + 3) dx$$

$$28. \int_0^2 e^x dx$$

Evaluate the following:

$$29. \int_0^1 \frac{dx}{e^x + e^{-x}}$$

$$30. \int_0^{\frac{\pi}{2}} \frac{\tan x dx}{1 + m^2 \tan^2 x}$$

$$31. \int_1^2 \frac{dx}{\sqrt{(x-1)(2-x)}}$$

$$32. \int_0^1 \frac{xdx}{\sqrt{1+x^2}}$$

$$33. \int_0^{\pi} x \sin x \cos^2 x dx$$

$$34. \int_0^{\frac{1}{2}} \frac{dx}{(1+x^2)\sqrt{1-x^2}}$$

(Hint: let $x = \sin \theta$)

Long Answer (L.A.)

$$35. \int \frac{x^2 dx}{x^4 - x^2 - 12}$$

$$36. \int \frac{x^2 dx}{(x^2 - a^2)(x^2 - b^2)}$$

$$37. \int_0^{\pi} \frac{x}{1 + \sin x}$$

$$38. \int \frac{2x-1}{(x-1)(x+2)(x-3)} dx$$

$$39. \int e^{\tan^{-1} x} \left(\frac{1+x+x^2}{1+x^2} \right) dx$$

$$40. \int \sin^{-1} \sqrt{\frac{x}{a+x}} dx$$

(Hint: Put $x = a \tan^2 \theta$)

$$41. \int_{\frac{\pi}{2}}^{\frac{\pi}{3}} \frac{\sqrt{1+\cos x}}{(1-\cos x)^{\frac{5}{2}}} dx$$

$$42. \int e^{-3x} \cos^3 x dx$$

$$43. \int \sqrt{\tan x} dx \quad (\text{Hint: Put } \tan x = t^2)$$

$$44. \int_0^{\frac{\pi}{2}} \frac{dx}{(a^2 \cos^2 x + b^2 \sin^2 x)^2}$$

(Hint: Divide Numerator and Denominator by $\cos^4 x$)

$$45. \int_0^1 x \log(1+2x) dx$$

$$46. \int_0^{\pi} x \log \sin x dx$$

$$47. \int_{-\frac{\pi}{4}}^{\frac{\pi}{4}} \log(\sin x + \cos x) dx$$

Objective Type Questions

Choose the correct option from given four options in each of the Exercises from 48 to 63.

$$48. \int \frac{\cos 2x - \cos 2\theta}{\cos x - \cos \theta} dx \text{ is equal to}$$

(A) $2(\sin x + x \cos \theta) + C$

(B) $2(\sin x - x \cos \theta) + C$

(C) $2(\sin x + 2x \cos \theta) + C$

(D) $2(\sin x - 2x \cos \theta) + C$

49. $\frac{dx}{\sin x - a \sin x - b}$ is equal to

(A) $\sin(b-a) \log \left| \frac{\sin(x-b)}{\sin(x-a)} \right| + C$ (B) $\operatorname{cosec}(b-a) \log \left| \frac{\sin(x-a)}{\sin(x-b)} \right| + C$

(C) $\operatorname{cosec}(b-a) \log \left| \frac{\sin(x-b)}{\sin(x-a)} \right| + C$ (D) $\sin(b-a) \log \left| \frac{\sin(x-a)}{\sin(x-b)} \right| + C$

50. $\int \tan^{-1} \sqrt{x} dx$ is equal to

(A) $(x+1) \tan^{-1} \sqrt{x} - \sqrt{x} + C$

(B) $x \tan^{-1} \sqrt{x} - \sqrt{x} + C$

(C) $\sqrt{x} - x \tan^{-1} \sqrt{x} + C$

(D) $\sqrt{x} - (x+1) \tan^{-1} \sqrt{x} + C$

51. $\int e^x \left(\frac{1-x}{1+x^2} \right)^2 dx$ is equal to

(A) $\frac{e^x}{1+x^2} + C$

(B) $\frac{-e^x}{1+x^2} + C$

(C) $\frac{e^x}{(1+x^2)^2} + C$

(D) $\frac{-e^x}{(1+x^2)^2} + C$

52. $\int \frac{x^9}{(4x^2+1)^6} dx$ is equal to

(A) $\frac{1}{5x} \left(4 + \frac{1}{x^2} \right)^{-5} + C$

(B) $\frac{1}{5} \left(4 + \frac{1}{x^2} \right)^{-5} + C$

(C) $\frac{1}{10x} (1+4)^{-5} + C$

(D) $\frac{1}{10} \left(\frac{1}{x^2} + 4 \right)^{-5} + C$

53. If $\int \frac{dx}{(x+2)(x^2+1)} = a \log |1+x^2| + b \tan^{-1}x + \frac{1}{5} \log |x+2| + C$, then

(A) $a = \frac{-1}{10}, b = \frac{-2}{5}$

(B) $a = \frac{1}{10}, b = -\frac{2}{5}$

(C) $a = \frac{-1}{10}, b = \frac{2}{5}$

(D) $a = \frac{1}{10}, b = \frac{2}{5}$

54. $\int \frac{x^3}{x+1}$ is equal to

(A) $x + \frac{x^2}{2} + \frac{x^3}{3} - \log|1-x| + C$

(B) $x + \frac{x^2}{2} - \frac{x^3}{3} - \log|1-x| + C$

(C) $x - \frac{x^2}{2} - \frac{x^3}{3} - \log|1+x| + C$

(D) $x - \frac{x^2}{2} + \frac{x^3}{3} - \log|1+x| + C$

55. $\int \frac{x + \sin x}{1 + \cos x} dx$ is equal to

(A) $\log|1 + \cos x| + C$

(B) $\log|x + \sin x| + C$

(C) $x - \tan \frac{x}{2} + C$

(D) $x \cdot \tan \frac{x}{2} + C$

56. If $\int \frac{x^3 dx}{\sqrt{1-x^2}} = a(1-x^2)^{\frac{3}{2}} + b\sqrt{1-x^2} + C$, then

(A) $a = \frac{1}{3}, b = 1$

(B) $a = \frac{-1}{3}, b = 1$

(C) $a = \frac{-1}{3}, b = -1$

(D) $a = \frac{1}{3}, b = -1$

57. $\int_{-\frac{\pi}{4}}^{\frac{\pi}{4}} \frac{dx}{1 + \cos 2x}$ is equal to

- (A) 1 (B) 2 (C) 3 (D) 4

58. $\int_0^{\frac{\pi}{2}} \sqrt{1 - \sin 2x} dx$ is equal to

- (A) $2\sqrt{2}$ (B) $2(\sqrt{2} + 1)$ (C) 2 (D) $2(\sqrt{2} - 1)$

59. $\int_0^{\frac{\pi}{2}} \cos x e^{\sin x} dx$ is equal to _____.

60. $\int \frac{x+3}{(x+4)^2} e^x dx =$ _____.

Fill in the blanks in each of the following Exercise 60 to 63.

61. If $\int_0^a \frac{1}{1+4x^2} dx = \frac{\pi}{8}$, then $a =$ _____.

62. $\int \frac{\sin x}{3+4\cos^2 x} dx =$ _____.

63. The value of $\int_{-\pi}^{\pi} \sin^3 x \cos^2 x dx$ is _____.



APPLICATION OF INTEGRALS

8.1 Overview

This chapter deals with a specific application of integrals to find the area under simple curves, area between lines and arcs of circles, parabolas and ellipses, and finding the area bounded by the above said curves.

8.1.1 The area of the region bounded by the curve $y = f(x)$, x -axis and the lines $x = a$ and $x = b$ ($b > a$) is given by the formula:

$$\text{Area} = \int_a^b y dx = \int_a^b f(x) dx$$

8.1.2 The area of the region bounded by the curve $x = \phi(y)$, y -axis and the lines $y = c$, $y = d$ is given by the formula:

$$\text{Area} = \int_c^d x dy = \int_c^d \phi(y) dy$$

8.1.3 The area of the region enclosed between two curves $y = f(x)$, $y = g(x)$ and the lines $x = a$, $x = b$ is given by the formula.

$$\text{Area} = \int_a^b f(x) - g(x) dx, \text{ where } f(x) \geq g(x) \text{ in } [a, b]$$

8.1.4 If $f(x) \geq g(x)$ in $[a, c]$ and $f(x) \leq g(x)$ in $[c, b]$, $a < c < b$, then

$$\text{Area} = \int_a^c f(x) - g(x) dx + \int_c^b g(x) - f(x) dx$$

8.2 Solved Examples

Short Answer (S.A.)

Example 1 Find the area of the curve $y = \sin x$ between 0 and π .

Solution We have

$$\begin{aligned} \text{Area OAB} &= \int_0^{\pi} y dx = \int_0^{\pi} \sin x dx = [-\cos x]_0^{\pi} \\ &= \cos 0 - \cos \pi = 2 \text{ sq units.} \end{aligned}$$

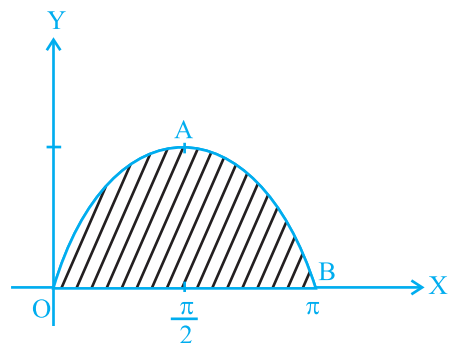

Fig. 8.1

Example 2 Find the area of the region bounded by the curve $ay^2 = x^3$, the y-axis and the lines $y = a$ and $y = 2a$.

Solution We have

$$\begin{aligned} \text{Area BMNC} &= \int_a^{2a} x dy = \int_a^{2a} a^{\frac{2}{3}} y^{\frac{2}{3}} dy \\ &= \frac{3a^{\frac{1}{3}}}{5} \left| y^{\frac{5}{3}} \right|_a^{2a} \\ &= \frac{3a^{\frac{1}{3}}}{5} \left| 2a^{\frac{5}{3}} - a^{\frac{5}{3}} \right| \\ &= \frac{3}{5} a^{\frac{1}{3}} a^{\frac{5}{3}} \left| (2)^{\frac{5}{3}} - 1 \right| \\ &= \frac{3}{5} a^2 \left| 2 \cdot 2^{\frac{2}{3}} - 1 \right| \text{ sq units.} \end{aligned}$$

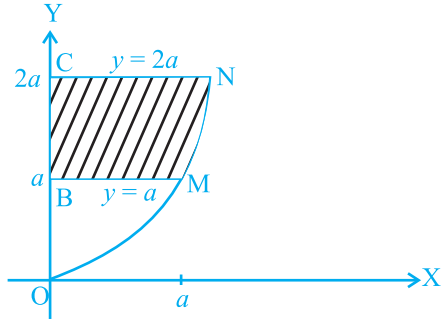

Fig. 8.2

Example 3 Find the area of the region bounded by the parabola $y^2 = 2x$ and the straight line $x - y = 4$.

Solution The intersecting points of the given curves are obtained by solving the equations $x - y = 4$ and $y^2 = 2x$ for x and y .

We have $y^2 = 8 + 2y$ i.e., $(y - 4)(y + 2) = 0$ which gives $y = 4, -2$ and $x = 8, 2$.

Thus, the points of intersection are $(8, 4), (2, -2)$. Hence

$$\begin{aligned} \text{Area} &= \int_{-2}^4 \left(4 + y - \frac{1}{2} y^2 \right) dy \\ &= \left| 4y + \frac{y^2}{2} - \frac{1}{6} y^3 \right|_{-2}^4 = 18 \text{ sq units.} \end{aligned}$$

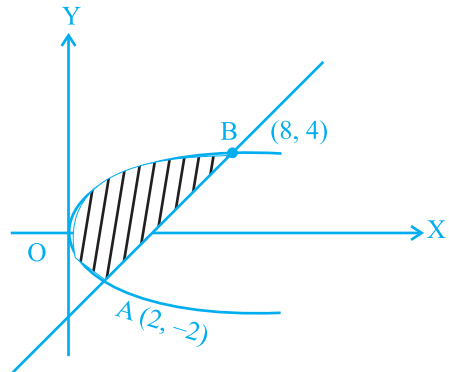

Fig. 8.3

Example 4 Find the area of the region bounded by the parabolas $y^2 = 6x$ and $x^2 = 6y$.

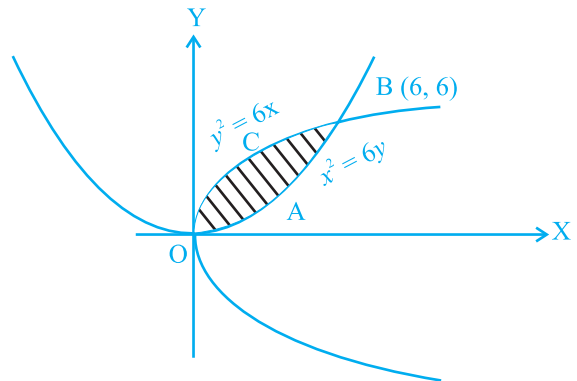

Fig. 8.4

Solution The intersecting points of the given parabolas are obtained by solving these equations for x and y , which are $0(0, 0)$ and $(6, 6)$. Hence

$$\text{Area OABC} = \int_0^6 \sqrt{6x} - \frac{x^2}{6} dx = \left| 2\sqrt{6} \frac{x^{\frac{3}{2}}}{\frac{3}{2}} - \frac{x^3}{18} \right|_0^6$$

$$= 2\sqrt{6} \frac{(6)^{\frac{3}{2}}}{3} - \frac{(6)^3}{18} = 12 \text{ sq units.}$$

Example 5 Find the area enclosed by the curve $x = 3 \cos t$, $y = 2 \sin t$.

Solution Eliminating t as follows:

$$x = 3 \cos t, \quad y = 2 \sin t \Rightarrow \frac{x}{3} = \cos t,$$

$$\frac{y}{2} = \sin t, \text{ we obtain}$$

$$\frac{x^2}{9} + \frac{y^2}{4} = 1,$$

which is the equation of an ellipse.

From Fig. 8.5, we get

$$\text{the required area} = 4 \int_0^3 \frac{2}{3} \sqrt{9-x^2} dx$$

$$= \frac{8}{3} \int_0^3 \sqrt{9-x^2} dx = \frac{9}{2} \sin^{-1} \frac{x}{3} \Big|_0^3 = 6\pi \text{ sq units.}$$

Long Answer (L.A.)

Example 6 Find the area of the region included between the parabola $y = \frac{3x^2}{4}$ and the line $3x - 2y + 12 = 0$.

Solution Solving the equations of the given curves $y = \frac{3x^2}{4}$ and $3x - 2y + 12 = 0$,

we get

$$3x^2 - 6x - 24 = 0 \Rightarrow (x - 4)(x + 2) = 0$$

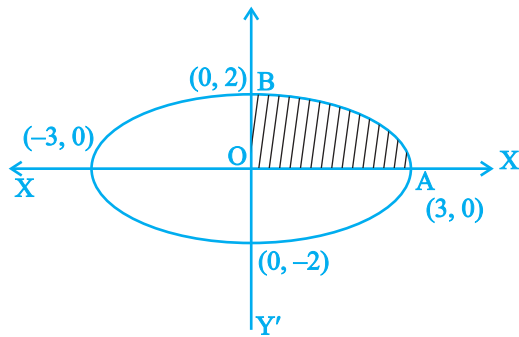

Fig. 8.5

$\Rightarrow x = 4, x = -2$ which give
 $y = 12, y = 3$

From Fig.8.6, the required area = area of ABC

$$= \int_{-2}^4 \frac{12 - 3x}{2} dx - \int_{-2}^4 \frac{3x^2}{4} dx$$

$$= \left(6x + \frac{3x^2}{4} \right)_{-2}^4 - \left| \frac{3x^3}{12} \right|_{-2}^4 = 27 \text{ sq units.}$$

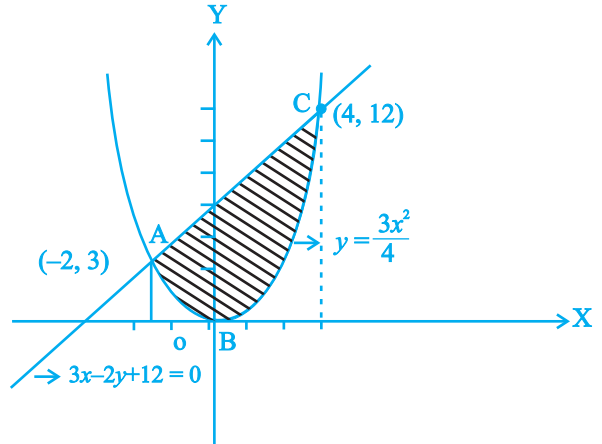

Fig. 8.6

Example 7 Find the area of the region bounded by the curves $x = at^2$ and $y = 2at$ between the ordinate corresponding to $t = 1$ and $t = 2$.

Solution Given that $x = at^2$... (i),

$y = 2at$... (ii) $\Rightarrow t = \frac{y}{2a}$ putting the value of t in (i), we get $y^2 = 4ax$

Putting $t = 1$ and $t = 2$ in (i), we get $x = a$, and $x = 4a$

Required area = 2 area of ABCD =

$$2 \int_a^{4a} y dx = 2 \times 2 \int_a^{4a} \sqrt{ax} dx$$

$$= 8\sqrt{a} \left| \frac{(x)^{\frac{3}{2}}}{3} \right|_a^{4a} = \frac{56}{3} a^2 \text{ sq units.}$$

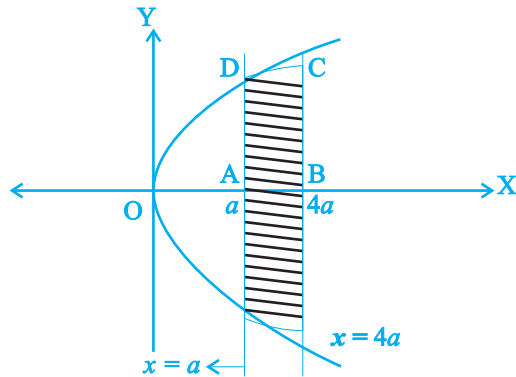

Fig. 8.7

Example 8 Find the area of the region above the x -axis, included between the parabola $y^2 = ax$ and the circle $x^2 + y^2 = 2ax$.

Solution Solving the given equations of curves, we have

$$x^2 + ax = 2ax$$

or $x = 0, x = a$, which give
 $y = 0. \quad y = \pm a$

From Fig. 8.8

area ODAB =

$$\int_0^a (\sqrt{2ax-x^2} - \sqrt{ax}) dx$$

Let $x = 2a \sin^2\theta$. Then $dx = 4a \sin\theta \cos\theta d\theta$ and

$$x = 0, \Rightarrow \theta = 0, \quad x = a \Rightarrow \theta = \frac{\pi}{4}.$$

Again, $\int_0^a \sqrt{2ax-x^2} dx$

$$= \int_0^{\frac{\pi}{4}} (2a \sin\theta \cos\theta) (4a \sin\theta \cos\theta) d\theta$$

$$= a^2 \int_0^{\frac{\pi}{4}} (1 - \cos 4\theta) d\theta = a^2 \left(\theta - \frac{\sin 4\theta}{4} \right)_0^{\frac{\pi}{4}} = \frac{\pi}{4} a^2.$$

Further more,

$$\int_0^a \sqrt{ax} dx = \sqrt{a} \frac{2}{3} \left(x^{\frac{3}{2}} \right)_0^a = \frac{2}{3} a^2$$

Thus the required area = $\frac{\pi}{4} a^2 - \frac{2}{3} a^2 = a^2 \left(\frac{\pi}{4} - \frac{2}{3} \right)$ sq units.

Example 9 Find the area of a minor segment of the circle $x^2 + y^2 = a^2$ cut off by the line $x = \frac{a}{2}$.

Solution Solving the equation $x^2 + y^2 = a^2$ and $x = \frac{a}{2}$, we obtain their points of

intersection which are $\frac{a}{2}, \sqrt{3} \frac{a}{2}$ and $\frac{a}{2}, -\frac{\sqrt{3}a}{2}$.

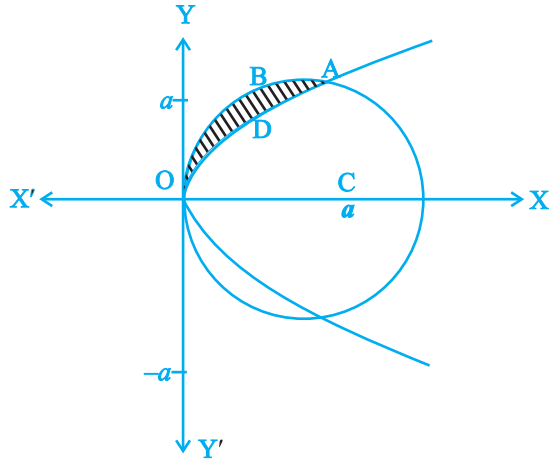

Fig. 8.8

Hence, from Fig. 8.9, we get

$$\text{Required Area} = 2 \text{ Area of OAB} = 2 \int_0^a \sqrt{a^2 - x^2} dx$$

$$= 2 \left[\frac{x}{2} \sqrt{a^2 - x^2} + \frac{a^2}{2} \sin^{-1} \frac{x}{a} \right]_0^a$$

$$= 2 \left[\frac{a^2}{2} \cdot \frac{\pi}{2} - \frac{a}{4} \cdot a \frac{\sqrt{3}}{2} - \frac{a^2}{2} \cdot \frac{\pi}{6} \right]$$

$$= \frac{a^2}{12} (6\pi - 3\sqrt{3} - 2\pi)$$

$$= \frac{a^2}{12} (4\pi - 3\sqrt{3}) \text{ sq units.}$$

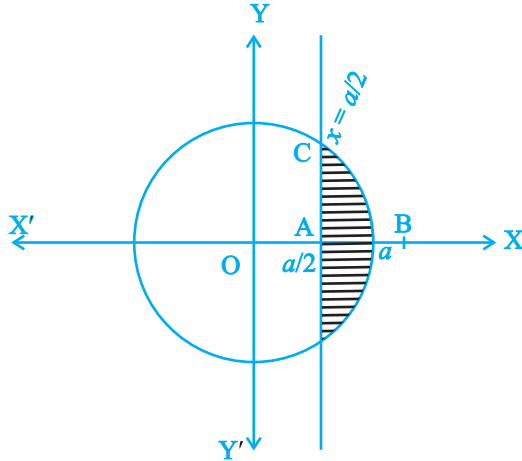

Fig. 8.9

Objective Type Questions

Choose the correct answer from the given four options in each of the Examples 10 to 12.

Example 10 The area enclosed by the circle $x^2 + y^2 = 2$ is equal to

- (A) 4π sq units
- (B) $2\sqrt{2}\pi$ sq units
- (C) $4\pi^2$ sq units
- (D) 2π sq units

Solution Correct answer is (D); since Area = $4 \int_0^{\sqrt{2}} \sqrt{2 - x^2} dx$

$$= 4 \left[\frac{x}{2} \sqrt{2 - x^2} + \sin^{-1} \frac{x}{\sqrt{2}} \right]_0^{\sqrt{2}} = 2\pi \text{ sq. units.}$$

Example 11 The area enclosed by the ellipse $\frac{x^2}{a^2} + \frac{y^2}{b^2} = 1$ is equal to

- (A) $\pi^2 ab$
- (B) πab
- (C) $\pi a^2 b$
- (D) πab^2

Solution Correct answer is (B); since Area = $4 \int_0^a \frac{b}{a} \sqrt{a^2 - x^2} dx$

$$= \frac{4b}{a} \left[\frac{x}{2} \sqrt{a^2 - x^2} + \frac{a^2}{2} \sin^{-1} \frac{x}{a} \right]_0^a = \pi ab.$$

Example 12 The area of the region bounded by the curve $y = x^2$ and the line $y = 16$

- (A) $\frac{32}{3}$, (B) $\frac{256}{3}$ (C) $\frac{64}{3}$ (D) $\frac{128}{3}$

Solution Correct answer is (B); since Area $= 2 \int_0^{16} \sqrt{y} dy$

Fill in the blanks in each of the Examples 13 and 14.

Example 13 The area of the region bounded by the curve $x = y^2$, y -axis and the line $y = 3$ and $y = 4$ is _____.

Solution $\frac{37}{3}$ sq. units

Example 14 The area of the region bounded by the curve $y = x^2 + x$, x -axis and the line $x = 2$ and $x = 5$ is equal to _____.

Solution $\frac{297}{6}$ sq. units

8.3 EXERCISES

Short Answer (S.A.)

- Find the area of the region bounded by the curves $y^2 = 9x$, $y = 3x$.
- Find the area of the region bounded by the parabola $y^2 = 2px$, $x^2 = 2py$.
- Find the area of the region bounded by the curve $y = x^3$ and $y = x + 6$ and $x = 0$.
- Find the area of the region bounded by the curve $y^2 = 4x$, $x^2 = 4y$.
- Find the area of the region included between $y^2 = 9x$ and $y = x$
- Find the area of the region enclosed by the parabola $x^2 = y$ and the line $y = x + 2$
- Find the area of region bounded by the line $x = 2$ and the parabola $y^2 = 8x$
- Sketch the region $\{(x, 0) : y = \sqrt{4 - x^2}\}$ and x -axis. Find the area of the region using integration.
- Calculate the area under the curve $y = 2\sqrt{x}$ included between the lines $x = 0$ and $x = 1$.
- Using integration, find the area of the region bounded by the line $2y = 5x + 7$, x -axis and the lines $x = 2$ and $x = 8$.

11. Draw a rough sketch of the curve $y = \sqrt{x-1}$ in the interval $[1, 5]$. Find the area under the curve and between the lines $x = 1$ and $x = 5$.
12. Determine the area under the curve $y = \sqrt{a^2 - x^2}$ included between the lines $x = 0$ and $x = a$.
13. Find the area of the region bounded by $y = \sqrt{x}$ and $y = x$.
14. Find the area enclosed by the curve $y = -x^2$ and the straight line $x + y + 2 = 0$.
15. Find the area bounded by the curve $y = \sqrt{x}$, $x = 2y + 3$ in the first quadrant and x -axis.

Long Answer (L.A.)

16. Find the area of the region bounded by the curve $y^2 = 2x$ and $x^2 + y^2 = 4x$.
17. Find the area bounded by the curve $y = \sin x$ between $x = 0$ and $x = 2\pi$.
18. Find the area of region bounded by the triangle whose vertices are $(-1, 1)$, $(0, 5)$ and $(3, 2)$, using integration.
19. Draw a rough sketch of the region $\{(x, y) : y^2 \leq 6ax \text{ and } x^2 + y^2 \leq 16a^2\}$. Also find the area of the region sketched using method of integration.
20. Compute the area bounded by the lines $x + 2y = 2$, $y - x = 1$ and $2x + y = 7$.
21. Find the area bounded by the lines $y = 4x + 5$, $y = 5 - x$ and $4y = x + 5$.
22. Find the area bounded by the curve $y = 2\cos x$ and the x -axis from $x = 0$ to $x = 2\pi$.
23. Draw a rough sketch of the given curve $y = 1 + |x + 1|$, $x = -3$, $x = 3$, $y = 0$ and find the area of the region bounded by them, using integration.

Objective Type Questions

Choose the correct answer from the given four options in each of the Exercises 24 to 34.

24. The area of the region bounded by the y -axis, $y = \cos x$ and $y = \sin x$, $0 \leq x \leq \frac{\pi}{2}$ is

(A) $\sqrt{2}$ sq units	(B) $(\sqrt{2} + 1)$ sq units
(C) $(\sqrt{2} - 1)$ sq units	(D) $(2\sqrt{2} - 1)$ sq units
25. The area of the region bounded by the curve $x^2 = 4y$ and the straight line $x = 4y - 2$ is

(A) $\frac{3}{8}$ sq units	(B) $\frac{5}{8}$ sq units	(C) $\frac{7}{8}$ sq units	(D) $\frac{9}{8}$ sq units
----------------------------	----------------------------	----------------------------	----------------------------
26. The area of the region bounded by the curve $y = \sqrt{16 - x^2}$ and x -axis is

(A) 8 sq units	(B) 20π sq units	(C) 16π sq units	(D) 256π sq units
----------------	----------------------	----------------------	-----------------------

27. Area of the region in the first quadrant enclosed by the x -axis, the line $y = x$ and the circle $x^2 + y^2 = 32$ is
(A) 16π sq units (B) 4π sq units (C) 32π sq units (D) 24 sq units
28. Area of the region bounded by the curve $y = \cos x$ between $x = 0$ and $x = \pi$ is
(A) 2 sq units (B) 4 sq units (C) 3 sq units (D) 1 sq units
29. The area of the region bounded by parabola $y^2 = x$ and the straight line $2y = x$ is
(A) $\frac{4}{3}$ sq units (B) 1 sq units (C) $\frac{2}{3}$ sq units (D) $\frac{1}{3}$ sq units
30. The area of the region bounded by the curve $y = \sin x$ between the ordinates $x = 0$, $x = \frac{\pi}{2}$ and the x -axis is
(A) 2 sq units (B) 4 sq units (C) 3 sq units (D) 1 sq units
31. The area of the region bounded by the ellipse $\frac{x^2}{25} + \frac{y^2}{16} = 1$ is
(A) 20π sq units (B) $20\pi^2$ sq units
(C) $16\pi^2$ sq units (D) 25π sq units
32. The area of the region bounded by the circle $x^2 + y^2 = 1$ is
(A) 2π sq units (B) π sq units (C) 3π sq units (D) 4π sq units
33. The area of the region bounded by the curve $y = x + 1$ and the lines $x = 2$ and $x = 3$ is
(A) $\frac{7}{2}$ sq units (B) $\frac{9}{2}$ sq units (C) $\frac{11}{2}$ sq units (D) $\frac{13}{2}$ sq units
34. The area of the region bounded by the curve $x = 2y + 3$ and the y lines. $y = 1$ and $y = -1$ is
(A) 4 sq units (B) $\frac{3}{2}$ sq units (C) 6 sq units (D) 8 sq units



DIFFERENTIAL EQUATIONS

9.1 Overview

- (i) An equation involving derivative (derivatives) of the dependent variable with respect to independent variable (variables) is called a differential equation.
- (ii) A differential equation involving derivatives of the dependent variable with respect to only one independent variable is called an ordinary differential equation and a differential equation involving derivatives with respect to more than one independent variables is called a partial differential equation.
- (iii) Order of a differential equation is the order of the highest order derivative occurring in the differential equation.
- (iv) Degree of a differential equation is defined if it is a polynomial equation in its derivatives.
- (v) Degree (when defined) of a differential equation is the highest power (positive integer only) of the highest order derivative in it.
- (vi) A relation between involved variables, which satisfy the given differential equation is called its solution. The solution which contains as many arbitrary constants as the order of the differential equation is called the general solution and the solution free from arbitrary constants is called particular solution.
- (vii) To form a differential equation from a given function, we differentiate the function successively as many times as the number of arbitrary constants in the given function and then eliminate the arbitrary constants.
- (viii) The order of a differential equation representing a family of curves is same as the number of arbitrary constants present in the equation corresponding to the family of curves.
- (ix) 'Variable separable method' is used to solve such an equation in which variables can be separated completely, i.e., terms containing x should remain with dx and terms containing y should remain with dy .

(x) A function $F(x, y)$ is said to be a homogeneous function of degree n if $F(\lambda x, \lambda y) = \lambda^n F(x, y)$ for some non-zero constant λ .

(xi) A differential equation which can be expressed in the form $\frac{dy}{dx} = F(x, y)$ or

$\frac{dx}{dy} = G(x, y)$, where $F(x, y)$ and $G(x, y)$ are homogeneous functions of degree zero, is called a homogeneous differential equation.

(xii) To solve a homogeneous differential equation of the type $\frac{dy}{dx} = F(x, y)$, we make substitution $y = vx$ and to solve a homogeneous differential equation of the type

$\frac{dx}{dy} = G(x, y)$, we make substitution $x = vy$.

(xiii) A differential equation of the form $\frac{dy}{dx} + Py = Q$, where P and Q are constants or functions of x only is known as a first order linear differential equation. Solution of such a differential equation is given by $y \text{ (I.F.)} = \int (Q \times \text{I.F.}) dx + C$, where

I.F. (Integrating Factor) = $e^{\int P dx}$.

(xiv) Another form of first order linear differential equation is $\frac{dx}{dy} + P_1 x = Q_1$, where

P_1 and Q_1 are constants or functions of y only. Solution of such a differential equation is given by $x \text{ (I.F.)} = \int (Q_1 \times \text{I.F.}) dy + C$, where I.F. = $e^{\int P_1 dy}$.

9.2 Solved Examples

Short Answer (S.A.)

Example 1 Find the differential equation of the family of curves $y = Ae^{2x} + B.e^{-2x}$.

Solution $y = Ae^{2x} + B.e^{-2x}$

$$\frac{dy}{dx} = 2Ae^{2x} - 2B.e^{-2x} \text{ and } \frac{d^2y}{dx^2} = 4Ae^{2x} + 4Be^{-2x}$$

Thus $\frac{d^2y}{dx^2} = 4y$ i.e., $\frac{d^2y}{dx^2} - 4y = 0$.

Example 2 Find the general solution of the differential equation $\frac{dy}{dx} = \frac{y}{x}$.

Solution $\frac{dy}{dx} = \frac{y}{x} \Rightarrow \frac{dy}{y} = \frac{dx}{x} \Rightarrow \frac{dy}{y} = \frac{dx}{x}$

$$\Rightarrow \log y = \log x + \log c \Rightarrow y = cx$$

Example 3 Given that $\frac{dy}{dx} = ye^x$ and $x = 0, y = e$. Find the value of y when $x = 1$.

Solution $\frac{dy}{dx} = ye^x \Rightarrow \frac{dy}{y} = e^x dx \Rightarrow \log y = e^x + c$

Substituting $x = 0$ and $y = e$, we get $\log e = e^0 + c$, i.e., $c = 0$ ($\because \log e = 1$)

Therefore, $\log y = e^x$.

Now, substituting $x = 1$ in the above, we get $\log y = e \Rightarrow y = e^e$.

Example 4 Solve the differential equation $\frac{dy}{dx} + \frac{y}{x} = x^2$.

Solution The equation is of the type $\frac{dy}{dx} + Py = Q$, which is a linear differential equation.

Now I.F. = $\int \frac{1}{x} dx = e^{\log x} = x$.

Therefore, solution of the given differential equation is

$$y \cdot x = \int x x^2 dx, \text{ i.e. } yx = \frac{x^4}{4} + c$$

$$\text{Hence } y = \frac{x^3}{4} + \frac{c}{x}.$$

Example 5 Find the differential equation of the family of lines through the origin.

Solution Let $y = mx$ be the family of lines through origin. Therefore, $\frac{dy}{dx} = m$

Eliminating m , we get $y = \frac{dy}{dx} \cdot x$ or $x \frac{dy}{dx} - y = 0$.

Example 6 Find the differential equation of all non-horizontal lines in a plane.

Solution The general equation of all non-horizontal lines in a plane is $ax + by = c$, where $a \neq 0$.

Therefore, $a \frac{dx}{dy} + b = 0$.

Again, differentiating both sides w.r.t. y , we get

$$a \frac{d^2x}{dy^2} = 0 \Rightarrow \frac{d^2x}{dy^2} = 0.$$

Example 7 Find the equation of a curve whose tangent at any point on it, different

from origin, has slope $y \frac{y}{x}$.

Solution Given $\frac{dy}{dx} = y \frac{y}{x} + 1 + \frac{1}{x}$

$$\Rightarrow \frac{dy}{y} = \left(1 + \frac{1}{x}\right) dx$$

Integrating both sides, we get

$$\log y = x + \log x + c \Rightarrow \log \frac{y}{x} = x + c$$

$$\Rightarrow \frac{y}{x} = e^{x+c} = e^x \cdot e^c \Rightarrow \frac{y}{x} = k \cdot e^x$$

$$\Rightarrow y = kx \cdot e^x.$$

Long Answer (L.A.)

Example 8 Find the equation of a curve passing through the point (1, 1) if the perpendicular distance of the origin from the normal at any point P(x, y) of the curve is equal to the distance of P from the x-axis.

Solution Let the equation of normal at P(x, y) be $Y - y = \frac{-dx}{dy}(X - x)$, i.e.,

$$Y + X \frac{dx}{dy} - y - x \frac{dx}{dy} = 0 \quad \dots(1)$$

Therefore, the length of perpendicular from origin to (1) is

$$\frac{y - x \frac{dx}{dy}}{\sqrt{1 + \left(\frac{dx}{dy}\right)^2}} \quad \dots(2)$$

Also distance between P and x-axis is |y|. Thus, we get

$$\frac{y - x \frac{dx}{dy}}{\sqrt{1 + \left(\frac{dx}{dy}\right)^2}} = |y|$$

$$\Rightarrow \left(y - x \frac{dx}{dy} \right)^2 = y^2 \left(1 + \frac{dx}{dy} \right)^2 \Rightarrow \frac{dx}{dy} \left(\frac{dx}{dy} x^2 - y^2 - 2xy \right) = 0 \Rightarrow \frac{dx}{dy} = 0$$

or
$$\frac{dx}{dy} = \frac{2xy}{y^2 - x^2}$$

Case I: $\frac{dx}{dy} = 0 \Rightarrow dx = 0$

Integrating both sides, we get $x = k$. Substituting $x = 1$, we get $k = 1$.

Therefore, $x = 1$ is the equation of curve (not possible, so rejected).

Case II: $\frac{dx}{dy} = \frac{2xy}{y^2 - x^2} \Rightarrow \frac{dy}{dx} = \frac{y^2 - x^2}{2xy}$. Substituting $y = vx$, we get

$$\begin{aligned} v \cdot x \frac{dv}{dx} \frac{v^2 x^2 - x^2}{2vx^2} &\Rightarrow x \cdot \frac{dv}{dx} \frac{v^2 - 1}{2v} \\ &= \frac{-(1+v^2)}{2v} \Rightarrow \frac{2v}{1-v^2} dv = \frac{dx}{x} \end{aligned}$$

Integrating both sides, we get

$$\begin{aligned} \log(1+v^2) &= -\log x + \log c \Rightarrow \log(1+v^2)(x) = \log c \Rightarrow (1+v^2)x = c \\ \Rightarrow x^2 + y^2 &= cx. \text{ Substituting } x = 1, \quad y = 1, \quad \text{we get } c = 2. \end{aligned}$$

Therefore, $x^2 + y^2 - 2x = 0$ is the required equation.

Example 9 Find the equation of a curve passing through $(1, \frac{1}{4})$ if the slope of the

tangent to the curve at any point $P(x, y)$ is $\frac{y}{x} - \cos^2 \frac{y}{x}$.

Solution According to the given condition

$$\frac{dy}{dx} = \frac{y}{x} - \cos^2 \frac{y}{x} \quad \dots (i)$$

This is a homogeneous differential equation. Substituting $y = vx$, we get

$$v + x \frac{dv}{dx} = v - \cos^2 v \Rightarrow x \frac{dv}{dx} = -\cos^2 v$$

$$\Rightarrow \sec^2 v \, dv = -\frac{dx}{x} \quad \Rightarrow \quad \tan v = -\log x + c$$

$$\Rightarrow \tan \frac{y}{x} + \log x = c \quad \dots(\text{ii})$$

Substituting $x = 1, y = \frac{\pi}{4}$, we get. $c = 1$. Thus, we get

$$\tan \frac{y}{x} + \log x = 1, \text{ which is the required equation.}$$

Example 10 Solve $x^2 \frac{dy}{dx} - xy = 1 + \cos\left(\frac{y}{x}\right), x \neq 0$ and $x = 1, y = \frac{\pi}{2}$

Solution Given equation can be written as

$$x^2 \frac{dy}{dx} - xy = 2\cos^2\left(\frac{y}{2x}\right), x \neq 0.$$

$$\Rightarrow \frac{x^2 \frac{dy}{dx} - xy}{2\cos^2\left(\frac{y}{2x}\right)} = 1 \quad \Rightarrow \quad \frac{\sec^2\left(\frac{y}{2x}\right)}{2} x^2 \frac{dy}{dx} - xy = 1$$

Dividing both sides by x^3 , we get

$$\frac{\sec^2\left(\frac{y}{2x}\right)}{2} \left[x \frac{dy}{dx} - y \right] = \frac{1}{x^3} \quad \Rightarrow \quad \frac{d}{dx} \tan \frac{y}{2x} = \frac{1}{x^3}$$

Integrating both sides, we get

$$\tan \frac{y}{2x} = \frac{1}{2x^2} + k.$$

Substituting $x = 1$, $y = \frac{3}{2}$, we get

$k = \frac{3}{2}$, therefore, $\tan^{-1} \frac{y}{2x} = \frac{1}{2x^2} + \frac{3}{2}$ is the required solution.

Example 11 State the type of the differential equation for the equation.

$xdy - ydx = \sqrt{x^2 - y^2} dx$ and solve it.

Solution Given equation can be written as $xdy = \sqrt{x^2 - y^2} + y dx$, i.e.,

$$\frac{dy}{dx} = \frac{\sqrt{x^2 - y^2} + y}{x} \quad \dots (1)$$

Clearly RHS of (1) is a homogeneous function of degree zero. Therefore, the given equation is a homogeneous differential equation. Substituting $y = vx$, we get from (1)

$$v + x \frac{dv}{dx} = \frac{\sqrt{x^2 - v^2 x^2} + vx}{x} \quad \text{i.e.} \quad v + x \frac{dv}{dx} = \sqrt{1 - v^2} + v$$

$$x \frac{dv}{dx} = \sqrt{1 - v^2} \Rightarrow \frac{dv}{\sqrt{1 - v^2}} = \frac{dx}{x} \quad \dots (2)$$

Integrating both sides of (2), we get

$$\log(v + \sqrt{1 - v^2}) = \log x + \log c \Rightarrow v + \sqrt{1 - v^2} = cx$$

$$\Rightarrow \frac{y}{x} + \sqrt{1 - \frac{y^2}{x^2}} = cx \quad \Rightarrow y + \sqrt{x^2 - y^2} = cx^2$$

Objective Type Questions

Choose the correct answer from the given four options in each of the Examples 12 to 21.

Example 12 The degree of the differential equation $\left(1 + \frac{dy}{dx}\right)^3 = \left(\frac{d^2y}{dx^2}\right)^2$ is

- (A) 1 (B) 2 (C) 3 (D) 4

Solution The correct answer is (B).

Example 13 The degree of the differential equation

$$\frac{d^2y}{dx^2} + 3\left(\frac{dy}{dx}\right)^2 = x^2 \log\left(\frac{d^2y}{dx^2}\right) \text{ is}$$

- (A) 1 (B) 2 (C) 3 (D) not defined

Solution Correct answer is (D). The given differential equation is not a polynomial equation in terms of its derivatives, so its degree is not defined.

Example 14 The order and degree of the differential equation $\left[1 + \left(\frac{dy}{dx}\right)^2\right]^2 = \frac{d^2y}{dx^2}$

respectively, are

- (A) 1, 2 (B) 2, 2 (C) 2, 1 (D) 4, 2

Solution Correct answer is (C).

Example 15 The order of the differential equation of all circles of given radius a is:

- (A) 1 (B) 2 (C) 3 (D) 4

Solution Correct answer is (B). Let the equation of given family be $(x - h)^2 + (y - k)^2 = a^2$. It has two arbitrary constants h and k . Therefore, the order of the given differential equation will be 2.

Example 16 The solution of the differential equation $2x \cdot \frac{dy}{dx} - y = 3$ represents a family of

- (A) straight lines (B) circles (C) parabolas (D) ellipses

Solution Correct answer is (C). Given equation can be written as

$$\frac{2dy}{y-3} - \frac{dx}{x} \Rightarrow 2\log(y+3) = \log x + \log c$$

$\Rightarrow (y+3)^2 = cx$ which represents the family of parabolas

Example 17 The integrating factor of the differential equation

$$\frac{dy}{dx} (x \log x) + y = 2\log x \text{ is}$$

- (A) e^x (B) $\log x$ (C) $\log(\log x)$ (D) x

Solution Correct answer is (B). Given equation can be written as $\frac{dy}{dx} \frac{y}{x \log x} = \frac{2}{x}$.

Therefore, I.F. = $e^{\int \frac{1}{x \log x} dx} = e^{\log(\log x)} = \log x$.

Example 18 A solution of the differential equation $\frac{dy}{dx} - x \frac{dy}{dx} = y - 0$ is

- (A) $y = 2$ (B) $y = 2x$ (C) $y = 2x - 4$ (D) $y = 2x^2 - 4$

Solution Correct answer is (C).

Example 19 Which of the following is not a homogeneous function of x and y .

- (A) $x^2 + 2xy$ (B) $2x - y$ (C) $\cos^2 \frac{y}{x} - \frac{y}{x}$ (D) $\sin x - \cos y$

Solution Correct answer is (D).

Example 20 Solution of the differential equation $\frac{dx}{x} + \frac{dy}{y} = 0$ is

- (A) $\frac{1}{x} + \frac{1}{y} = c$ (B) $\log x \cdot \log y = c$ (C) $xy = c$ (D) $x + y = c$

Solution Correct answer is (C). From the given equation, we get $\log x + \log y = \log c$ giving $xy = c$.

Example 21 The solution of the differential equation $x \frac{dy}{dx} - 2y = x^2$ is

(A) $y = \frac{x^2 + c}{4x^2}$ (B) $y = \frac{x^2}{4} + c$ (C) $y = \frac{x^4 + c}{x^2}$ (D) $y = \frac{x^4 + c}{4x^2}$

Solution Correct answer is (D). I.F. = $e^{\int \frac{2}{x} dx} = e^{2 \log x} = e^{\log x^2} = x^2$. Therefore, the solution is $y \cdot x^2 = \int x^2 \cdot x dx = \frac{x^4}{4} + k$, i.e., $y = \frac{x^4 + c}{4x^2}$.

Example 22 Fill in the blanks of the following:

(i) Order of the differential equation representing the family of parabolas $y^2 = 4ax$ is _____.

(ii) The degree of the differential equation $\left(\frac{dy}{dx}\right)^3 + \left(\frac{d^2y}{dx^2}\right)^2 = 0$ is _____.

(iii) The number of arbitrary constants in a particular solution of the differential equation $\tan x dx + \tan y dy = 0$ is _____.

(iv) $F(x, y) = \frac{\sqrt{x^2 + y^2} + y}{x}$ is a homogeneous function of degree _____.

(v) An appropriate substitution to solve the differential equation

$$\frac{dx}{dy} = \frac{x^2 \log \frac{x}{y} - x^2}{xy \log \frac{x}{y}}$$

is _____.

(vi) Integrating factor of the differential equation $x \frac{dy}{dx} - y = \sin x$ is _____.

(vii) The general solution of the differential equation $\frac{dy}{dx} = e^{x-y}$ is _____.

(viii) The general solution of the differential equation $\frac{dy}{dx} + \frac{y}{x} = 1$ is _____.

(ix) The differential equation representing the family of curves $y = A \sin x + B \cos x$ is _____.

(x) $\frac{e^{2\sqrt{x}}}{\sqrt{x}} \frac{y}{\sqrt{x}} \frac{dx}{dy} + 1(x \neq 0)$ when written in the form $\frac{dy}{dx} + Py = Q$, then

$P =$ _____.

Solution

(i) One; a is the only arbitrary constant.

(ii) Two; since the degree of the highest order derivative is two.

(iii) Zero; any particular solution of a differential equation has no arbitrary constant.

(iv) Zero.

(v) $x = vy$.

(vi) $\frac{1}{x}$; given differential equation can be written as $\frac{dy}{dx} - \frac{y}{x} = \frac{\sin x}{x}$ and therefore

$$\text{I.F.} = e^{\int \frac{1}{x} dx} = e^{-\log x} = \frac{1}{x}.$$

(vii) $e^y = e^x + c$ from given equation, we have $e^y dy = e^x dx$.

(viii) $xy = \frac{x^2}{2} + c$; I.F. $= e^{\int \frac{1}{x} dx} = e^{\log x} = x$ and the solution is $y \cdot x = \int x \cdot 1 dx = \frac{x^2}{2} + C$.

(ix) $\frac{d^2 y}{dx^2} + y = 0$; Differentiating the given function w.r.t. x successively, we get

$$\frac{dy}{dx} = A \cos x - B \sin x \quad \text{and} \quad \frac{d^2 y}{dx^2} = -A \sin x - B \cos x$$

$$\Rightarrow \frac{d^2 y}{dx^2} + y = 0 \text{ is the differential equation.}$$

(x) $\frac{1}{\sqrt{x}}$; the given equation can be written as

$$\frac{dy}{dx} = \frac{e^{-2\sqrt{x}}}{\sqrt{x}} \frac{y}{\sqrt{x}} \quad \text{i.e.} \quad \frac{dy}{dx} + \frac{y}{\sqrt{x}} = \frac{e^{-2\sqrt{x}}}{\sqrt{x}}$$

This is a differential equation of the type $\frac{dy}{dx} + Py = Q$.

Example 23 State whether the following statements are **True** or **False**.

- (i) Order of the differential equation representing the family of ellipses having centre at origin and foci on x -axis is two.
- (ii) Degree of the differential equation $\sqrt{1 + \frac{d^2y}{dx^2}} = x + \frac{dy}{dx}$ is not defined.
- (iii) $\frac{dy}{dx} y^5$ is a differential equation of the type $\frac{dy}{dx} + Py = Q$ but it can be solved using variable separable method also.
- (iv) $F(x, y) = \frac{y \cos\left(\frac{y}{x}\right) + x}{x \cos\left(\frac{y}{x}\right)}$ is not a homogeneous function.
- (v) $F(x, y) = \frac{x^2 - y^2}{x + y}$ is a homogeneous function of degree 1.
- (vi) Integrating factor of the differential equation $\frac{dy}{dx} y \cos x$ is e^x .
- (vii) The general solution of the differential equation $x(1 + y^2)dx + y(1 + x^2)dy = 0$ is $(1 + x^2)(1 + y^2) = k$.
- (viii) The general solution of the differential equation $\frac{dy}{dx} + y \sec x = \tan x$ is $y(\sec x - \tan x) = \sec x - \tan x + x + k$.
- (ix) $x + y = \tan^{-1}y$ is a solution of the differential equation $y^2 \frac{dy}{dx} - y^2 - 1 = 0$

- (x) $y = x$ is a particular solution of the differential equation $\frac{d^2y}{dx^2} - x^2 \frac{dy}{dx} - xy = x$.

Solution

- (i) True, since the equation representing the given family is $\frac{x^2}{a^2} + \frac{y^2}{b^2} = 1$, which has two arbitrary constants.
- (ii) True, because it is not a polynomial equation in its derivatives.
- (iii) True
- (iv) True, because $f(\lambda x, \lambda y) = \lambda^0 f(x, y)$.
- (v) True, because $f(\lambda x, \lambda y) = \lambda^1 f(x, y)$.
- (vi) False, because I.F. = $e^{-1dx} = e^{-x}$.
- (vii) True, because given equation can be written as

$$\frac{2x}{1+x^2} dx + \frac{2y}{1+y^2} dy$$

$$\Rightarrow \log(1+x^2) = -\log(1+y^2) + \log k$$

$$\Rightarrow (1+x^2)(1+y^2) = k$$

- (viii) False, since I.F. = $e^{\int \sec x dx} = e^{\log(\sec x + \tan x)} = \sec x + \tan x$, the solution is,

$$y(\sec x + \tan x) = \int (\sec x + \tan x) \tan x dx = \int (\sec x \tan x + \sec^2 x - 1) dx =$$

$$\sec x + \tan x - x + k$$

- (ix) True, $x + y = \tan^{-1}y \Rightarrow 1 + \frac{dy}{dx} = \frac{1}{1+y^2} \frac{dy}{dx}$

$$\Rightarrow \frac{dy}{dx} \left(\frac{1}{1+y^2} - 1 \right) = 1, \text{ i.e., } \frac{dy}{dx} = \frac{(1+y^2)}{y^2} \text{ which satisfies the given equation.}$$

(x) False, because $y = x$ does not satisfy the given differential equation.

9.3 EXERCISE

Short Answer (S.A.)

1. Find the solution of $\frac{dy}{dx} = 2^y - x$.
2. Find the differential equation of all non vertical lines in a plane.
3. Given that $\frac{dy}{dx} = e^{2y}$ and $y = 0$ when $x = 5$.
Find the value of x when $y = 3$.
4. Solve the differential equation $(x^2 - 1) \frac{dy}{dx} + 2xy = \frac{1}{x^2 - 1}$.
5. Solve the differential equation $\frac{dy}{dx} = 2xy - y$.
6. Find the general solution of $\frac{dy}{dx} = ay - e^{mx}$.
7. Solve the differential equation $\frac{dy}{dx} = 1 - e^{x-y}$.
8. Solve: $ydx - xdy = x^2ydx$.
9. Solve the differential equation $\frac{dy}{dx} = 1 + x + y^2 + xy^2$, when $y = 0, x = 0$.
10. Find the general solution of $(x + 2y^3) \frac{dy}{dx} = y$.
11. If $y(x)$ is a solution of $\frac{2 \sin x}{1 - y} \frac{dy}{dx} = -\cos x$ and $y(0) = 1$, then find the value
of $y = \frac{1}{2}$.
12. If $y(t)$ is a solution of $(1 + t) \frac{dy}{dt} - ty = 1$ and $y(0) = -1$, then show that
 $y(1) = -\frac{1}{2}$.

13. Form the differential equation having $y = (\sin^{-1}x)^2 + A\cos^{-1}x + B$, where A and B are arbitrary constants, as its general solution.
14. Form the differential equation of all circles which pass through origin and whose centres lie on y-axis.
15. Find the equation of a curve passing through origin and satisfying the differential equation $(1 - x^2)\frac{dy}{dx} - 2xy = 4x^2$.
16. Solve : $x^2\frac{dy}{dx} = x^2 + xy + y^2$.
17. Find the general solution of the differential equation $(1 + y^2) + (x - e^{\tan^{-1}y})\frac{dy}{dx} = 0$.
18. Find the general solution of $y^2dx + (x^2 - xy + y^2)dy = 0$.
19. Solve : $(x + y)(dx - dy) = dx + dy$. [Hint: Substitute $x + y = z$ after seperating dx and dy]
20. Solve : $2(y + 3) - xy\frac{dy}{dx} = 0$, given that $y(1) = -2$.
21. Solve the differential equation $dy = \cos x(2 - y \operatorname{cosec} x) dx$ given that $y = 2$ when $x = \frac{\pi}{2}$.
22. Form the differential equation by eliminating A and B in $Ax^2 + By^2 = 1$.
23. Solve the differential equation $(1 + y^2)\tan^{-1}x dx + 2y(1 + x^2)dy = 0$.
24. Find the differential equation of system of concentric circles with centre (1, 2).

Long Answer (L.A.)

25. Solve : $y + \frac{d}{dx}(xy) = x(\sin x + \log x)$
26. Find the general solution of $(1 + \tan y)(dx - dy) + 2xdy = 0$.
27. Solve : $\frac{dy}{dx} = \cos(x + y) + \sin(x + y)$. [Hint: Substitute $x + y = z$]
28. Find the general solution of $\frac{dy}{dx} = 3y - \sin 2x$.
29. Find the equation of a curve passing through (2, 1) if the slope of the tangent to the curve at any point (x, y) is $\frac{x^2 - y^2}{2xy}$.

30. Find the equation of the curve through the point (1, 0) if the slope of the tangent to the curve at any point (x, y) is $\frac{y-1}{x^2}$.
31. Find the equation of a curve passing through origin if the slope of the tangent to the curve at any point (x, y) is equal to the square of the difference of the abscissa and ordinate of the point.
32. Find the equation of a curve passing through the point (1, 1). If the tangent drawn at any point P (x, y) on the curve meets the co-ordinate axes at A and B such that P is the mid-point of AB.
33. Solve : $x \frac{dy}{dx} = y (\log y - \log x + 1)$

Objective Type

Choose the correct answer from the given four options in each of the Exercises from 34 to 75 (M.C.Q)

34. The degree of the differential equation $\frac{d^2y}{dx^2} + \frac{dy}{dx} + x \sin \frac{dy}{dx}$ is:
 (A) 1 (B) 2 (C) 3 (D) not defined
35. The degree of the differential equation $1 + \frac{dy}{dx} + \frac{d^2y}{dx^2}$ is
 (A) 4 (B) $\frac{3}{2}$ (C) not defined (D) 2
36. The order and degree of the differential equation $\frac{d^2y}{dx^2} + \frac{dy}{dx} + x^{\frac{1}{4}} + x^{\frac{1}{5}} = 0$, respectively, are
 (A) 2 and not defined (B) 2 and 2 (C) 2 and 3 (D) 3 and 3
37. If $y = e^{-x} (A \cos x + B \sin x)$, then y is a solution of
 (A) $\frac{d^2y}{dx^2} + 2 \frac{dy}{dx} + 2y = 0$ (B) $\frac{d^2y}{dx^2} - 2 \frac{dy}{dx} + 2y = 0$
 (C) $\frac{d^2y}{dx^2} - 2 \frac{dy}{dx} - 2y = 0$ (D) $\frac{d^2y}{dx^2} + 2y = 0$

38. The differential equation for $y = A\cos \alpha x + B\sin \alpha x$, where A and B are arbitrary constants is

(A) $\frac{d^2 y}{dx^2} - \alpha^2 y = 0$ (B) $\frac{d^2 y}{dx^2} + \alpha^2 y = 0$

(C) $\frac{d^2 y}{dx^2} - y = 0$ (D) $\frac{d^2 y}{dx^2} + y = 0$

39. Solution of differential equation $xdy - ydx = 0$ represents :

- (A) a rectangular hyperbola
 (B) parabola whose vertex is at origin
 (C) straight line passing through origin
 (D) a circle whose centre is at origin

40. Integrating factor of the differential equation $\cos x \frac{dy}{dx} + y \sin x = 1$ is :

- (A) $\cos x$ (B) $\tan x$ (C) $\sec x$ (D) $\sin x$

41. Solution of the differential equation $\tan y \sec^2 x dx + \tan x \sec^2 y dy = 0$ is :

- (A) $\tan x + \tan y = k$ (B) $\tan x - \tan y = k$

(C) $\frac{\tan x}{\tan y} = k$ (D) $\tan x \cdot \tan y = k$

42. Family $y = Ax + A^3$ of curves is represented by the differential equation of degree :

- (A) 1 (B) 2 (C) 3 (D) 4

43. Integrating factor of $\frac{xdy}{dx} - y = x^4 - 3x$ is :

- (A) x (B) $\log x$ (C) $\frac{1}{x}$ (D) $-x$

44. Solution of $\frac{dy}{dx} - y = 1$, $y(0) = 1$ is given by

- (A) $xy = -e^x$ (B) $xy = -e^{-x}$ (C) $xy = -1$ (D) $y = 2e^x - 1$

45. The number of solutions of $\frac{dy}{dx} = \frac{y+1}{x-1}$ when $y(1) = 2$ is :
 (A) none (B) one (C) two (D) infinite
46. Which of the following is a second order differential equation?
 (A) $(y')^2 + x = y^2$ (B) $y'y'' + y = \sin x$
 (C) $y''' + (y'')^2 + y = 0$ (D) $y' = y^2$
47. Integrating factor of the differential equation $(1 - x^2) \frac{dy}{dx} - xy = 1$ is
 (A) $-x$ (B) $\frac{x}{1 - x^2}$ (C) $\sqrt{1 - x^2}$ (D) $\frac{1}{2} \log(1 - x^2)$
48. $\tan^{-1} x + \tan^{-1} y = c$ is the general solution of the differential equation:
 (A) $\frac{dy}{dx} = \frac{1+y^2}{1+x^2}$ (B) $\frac{dy}{dx} = \frac{1+x^2}{1+y^2}$
 (C) $(1 + x^2) dy + (1 + y^2) dx = 0$ (D) $(1 + x^2) dx + (1 + y^2) dy = 0$
49. The differential equation $y \frac{dy}{dx} + x = c$ represents :
 (A) Family of hyperbolas (B) Family of parabolas
 (C) Family of ellipses (D) Family of circles
50. The general solution of $e^x \cos y dx - e^x \sin y dy = 0$ is :
 (A) $e^x \cos y = k$ (B) $e^x \sin y = k$
 (C) $e^x = k \cos y$ (D) $e^x = k \sin y$
51. The degree of the differential equation $\frac{d^2y}{dx^2} + \left(\frac{dy}{dx}\right)^3 + 6y^5 = 0$ is :
 (A) 1 (B) 2 (C) 3 (D) 5
52. The solution of $\frac{dy}{dx} + y = e^{-x}$, $y(0) = 0$ is :
 (A) $y = e^x(x - 1)$ (B) $y = xe^{-x}$
 (C) $y = xe^{-x} + 1$ (D) $y = (x + 1)e^{-x}$

53. Integrating factor of the differential equation $\frac{dy}{dx} y \tan x - \sec x = 0$ is:
- (A) $\cos x$ (B) $\sec x$
 (C) $e^{\cos x}$ (D) $e^{\sec x}$
54. The solution of the differential equation $\frac{dy}{dx} = \frac{1-y^2}{1+x^2}$ is:
- (A) $y = \tan^{-1} x$ (B) $y - x = k(1 + xy)$
 (C) $x = \tan^{-1} y$ (D) $\tan(xy) = k$
55. The integrating factor of the differential equation $\frac{dy}{dx} + y = \frac{1+y}{x}$ is:
- (A) $\frac{x}{e^x}$ (B) $\frac{e^x}{x}$
 (C) xe^x (D) e^x
56. $y = ae^{mx} + be^{-mx}$ satisfies which of the following differential equation?
- (A) $\frac{dy}{dx} - my = 0$ (B) $\frac{dy}{dx} + my = 0$
 (C) $\frac{d^2y}{dx^2} - m^2y = 0$ (D) $\frac{d^2y}{dx^2} + m^2y = 0$
57. The solution of the differential equation $\cos x \sin y \, dx + \sin x \cos y \, dy = 0$ is :
- (A) $\frac{\sin x}{\sin y} = c$ (B) $\sin x \sin y = c$
 (C) $\sin x + \sin y = c$ (D) $\cos x \cos y = c$
58. The solution of $x \frac{dy}{dx} + y = e^x$ is:
- (A) $y = \frac{e^x}{x} + \frac{k}{x}$ (B) $y = xe^x + cx$
 (C) $y = xe^x + k$ (D) $x = \frac{e^y}{y} + \frac{k}{y}$

59. The differential equation of the family of curves $x^2 + y^2 - 2ay = 0$, where a is arbitrary constant, is:

(A) $(x^2 - y^2) \frac{dy}{dx} = 2xy$

(B) $2(x^2 + y^2) \frac{dy}{dx} = xy$

(C) $2(x^2 - y^2) \frac{dy}{dx} = xy$

(D) $(x^2 + y^2) \frac{dy}{dx} = 2xy$

60. Family $y = Ax + A^3$ of curves will correspond to a differential equation of order

(A) 3

(B) 2

(C) 1

(D) not defined

61. The general solution of $\frac{dy}{dx} = 2x e^{x^2-y}$ is :

(A) $e^{x^2-y} = c$

(B) $e^{-y} + e^{x^2} = c$

(C) $e^y = e^{x^2} + c$

(D) $e^{x^2+y} = c$

62. The curve for which the slope of the tangent at any point is equal to the ratio of the abscissa to the ordinate of the point is :

(A) an ellipse

(B) parabola

(C) circle

(D) rectangular hyperbola

63. The general solution of the differential equation $\frac{dy}{dx} e^{\frac{x^2}{2}} + xy$ is :

(A) $y = ce^{\frac{x^2}{2}}$

(B) $y = ce^{\frac{x^2}{2}}$

(C) $y = (x+c)e^{\frac{x^2}{2}}$

(D) $y = (c-x)e^{\frac{x^2}{2}}$

64. The solution of the equation $(2y - 1) dx - (2x + 3)dy = 0$ is :

(A) $\frac{2x-1}{2y-3} = k$

(B) $\frac{2y+1}{2x-3} = k$

(C) $\frac{2x-3}{2y-1} = k$

(D) $\frac{2x-1}{2y-1} = k$

65. The differential equation for which $y = a\cos x + b\sin x$ is a solution, is :

(A) $\frac{d^2 y}{dx^2} + y = 0$

(B) $\frac{d^2 y}{dx^2} - y = 0$

(C) $\frac{d^2 y}{dx^2} + (a + b)y = 0$

(D) $\frac{d^2 y}{dx^2} + (a - b)y = 0$

66. The solution of $\frac{dy}{dx} + y = e^{-x}$, $y(0) = 0$ is :

(A) $y = e^{-x}(x - 1)$

(B) $y = xe^x$

(C) $y = xe^{-x} + 1$

(D) $y = xe^{-x}$

67. The order and degree of the differential equation

$$\frac{d^3 y}{dx^3}^2 - 3\frac{d^2 y}{dx^2} - 2\frac{dy}{dx} - y^4 \text{ are :}$$

(A) 1, 4

(B) 3, 4

(C) 2, 4

(D) 3, 2

68. The order and degree of the differential equation $\left[1 + \left(\frac{dy}{dx}\right)^2\right] = \frac{d^2 y}{dx^2}$ are :

(A) 2, $\frac{3}{2}$

(B) 2, 3

(C) 2, 1

(D) 3, 4

69. The differential equation of the family of curves $y^2 = 4a(x + a)$ is :

(A) $y^2 = 4\frac{dy}{dx}\left(x + \frac{dy}{dx}\right)$

(B) $2y\frac{dy}{dx} - 4a$

(C) $y\frac{d^2 y}{dx^2} - \frac{dy}{dx}^2 = 0$

(D) $2x\frac{dy}{dx} + y\left(\frac{dy}{dx}\right)^2 - y$

70. Which of the following is the general solution of $\frac{d^2 y}{dx^2} - 2\frac{dy}{dx} + y = 0$?

(A) $y = (Ax + B)e^x$

(B) $y = (Ax + B)e^{-x}$

(C) $y = Ae^x + Be^{-x}$

(D) $y = A\cos x + B\sin x$

71. General solution of $\frac{dy}{dx} + y \tan x = \sec x$ is :
- (A) $y \sec x = \tan x + c$ (B) $y \tan x = \sec x + c$
 (C) $\tan x = y \tan x + c$ (D) $x \sec x = \tan y + c$
72. Solution of the differential equation $\frac{dy}{dx} \frac{y}{x} \sin x$ is :
- (A) $x(y + \cos x) = \sin x + c$ (B) $x(y - \cos x) = \sin x + c$
 (C) $xy \cos x = \sin x + c$ (D) $x(y + \cos x) = \cos x + c$
73. The general solution of the differential equation $(e^x + 1) y dy = (y + 1) e^x dx$ is:
- (A) $(y + 1) = k(e^x + 1)$ (B) $y + 1 = e^x + 1 + k$
 (C) $y = \log \{k(y + 1)(e^x + 1)\}$ (D) $y \log \frac{e^x - 1}{y - 1} = k$
74. The solution of the differential equation $\frac{dy}{dx} = e^{x-y} + x^2 e^{-y}$ is :
- (A) $y = e^{x-y} - x^2 e^{-y} + c$ (B) $e^y - e^x = \frac{x^3}{3} + c$
 (C) $e^x + e^y = \frac{x^3}{3} + c$ (D) $e^x - e^y = \frac{x^3}{3} + c$
75. The solution of the differential equation $\frac{dy}{dx} \frac{2xy}{1-x^2} - \frac{1}{(1-x^2)^2}$ is :
- (A) $y(1+x^2) = c + \tan^{-1}x$ (B) $\frac{y}{1-x^2} = c + \tan^{-1}x$
 (C) $y \log(1+x^2) = c + \tan^{-1}x$ (D) $y(1+x^2) = c + \sin^{-1}x$
76. Fill in the blanks of the following (i to xi)
- (i) The degree of the differential equation $\frac{d^2y}{dx^2} e^{\frac{dy}{dx}} = 0$ is _____.
- (ii) The degree of the differential equation $\sqrt{1 + \frac{dy}{dx}^2} = x$ is _____.

- (iii) The number of arbitrary constants in the general solution of a differential equation of order three is _____.
- (iv) $\frac{dy}{dx} - \frac{y}{x \log x} - \frac{1}{x}$ is an equation of the type _____.
- (v) General solution of the differential equation of the type $\frac{dx}{dy} + P_1 x = Q_1$ is given by _____.
- (vi) The solution of the differential equation $\frac{xdy}{dx} - 2y = x^2$ is _____.
- (vii) The solution of $(1 + x^2) \frac{dy}{dx} + 2xy - 4x^2 = 0$ is _____.
- (viii) The solution of the differential equation $ydx + (x + xy)dy = 0$ is _____.
- (ix) General solution of $\frac{dy}{dx} - y = \sin x$ is _____.
- (x) The solution of differential equation $\cot y \, dx = xdy$ is _____.
- (xi) The integrating factor of $\frac{dy}{dx} - y = \frac{1}{x}$ is _____.

77. State **True** or **False** for the following:

- (i) Integrating factor of the differential of the form $\frac{dx}{dy} + p_1 x = Q_1$ is given by $e^{\int p_1 dy}$.
- (ii) Solution of the differential equation of the type $\frac{dx}{dy} + p_1 x = Q_1$ is given by $x \cdot \text{I.F.} = \int Q_1 dy$.
- (iii) Correct substitution for the solution of the differential equation of the type $\frac{dy}{dx} = f(x, y)$, where $f(x, y)$ is a homogeneous function of zero degree is $y = vx$.

- (iv) Correct substitution for the solution of the differential equation of the type $\frac{dx}{dy} = g(x, y)$ where $g(x, y)$ is a homogeneous function of the degree zero is $x = vy$.
- (v) Number of arbitrary constants in the particular solution of a differential equation of order two is two.
- (vi) The differential equation representing the family of circles $x^2 + (y - a)^2 = a^2$ will be of order two.
- (vii) The solution of $\frac{dy}{dx} = \frac{y}{x} + \frac{1}{y^3} - \frac{2}{x^3} = c$.
- (viii) Differential equation representing the family of curves $y = e^x (A \cos x + B \sin x)$ is $\frac{d^2y}{dx^2} - 2\frac{dy}{dx} - 2y = 0$
- (ix) The solution of the differential equation $\frac{dy}{dx} = \frac{x+2y}{x}$ is $x + y = kx^2$.
- (x) Solution of $\frac{xdy}{dx} = y - x \tan \frac{y}{x}$ is $\sin \frac{y}{x} = cx$
- (xi) The differential equation of all non horizontal lines in a plane is $\frac{d^2x}{dy^2} = 0$.



VECTOR ALGEBRA**10.1 Overview**

10.1.1 A quantity that has magnitude as well as direction is called a vector.

10.1.2 The unit vector in the direction of \vec{a} is given by $\frac{\vec{a}}{|\vec{a}|}$ and is represented by \hat{a} .

10.1.3 Position vector of a point P (x, y, z) is given as $\vec{OP} = x\hat{i} + y\hat{j} + z\hat{k}$ and its magnitude as $|\vec{OP}| = \sqrt{x^2 + y^2 + z^2}$, where O is the origin.

10.1.4 The scalar components of a vector are its direction ratios, and represent its projections along the respective axes.

10.1.5 The magnitude r , direction ratios (a, b, c) and direction cosines (l, m, n) of any vector are related as:

$$l = \frac{a}{r}, m = \frac{b}{r}, n = \frac{c}{r}.$$

10.1.6 The sum of the vectors representing the three sides of a triangle taken in order is $\vec{0}$.

10.1.7 The triangle law of vector addition states that “If two vectors are represented by two sides of a triangle taken in order, then their sum or resultant is given by the third side taken in opposite order”.

10.1.8 Scalar multiplication

If \vec{a} is a given vector and λ a scalar, then $\lambda\vec{a}$ is a vector whose magnitude is $|\lambda\vec{a}| = |\lambda||\vec{a}|$. The direction of $\lambda\vec{a}$ is same as that of \vec{a} if λ is positive and, opposite to that of \vec{a} if λ is negative.

10.1.9 Vector joining two points

If $P_1(x_1, y_1, z_1)$ and $P_2(x_2, y_2, z_2)$ are any two points, then

$$\overrightarrow{P_1P_2} = (x_2 - x_1)\hat{i} + (y_2 - y_1)\hat{j} + (z_2 - z_1)\hat{k}$$

$$|\overrightarrow{P_1P_2}| = \sqrt{(x_2 - x_1)^2 + (y_2 - y_1)^2 + (z_2 - z_1)^2}$$

10.1.10 Section formula

The position vector of a point R dividing the line segment joining the points P and Q whose position vectors are \vec{a} and \vec{b}

(i) in the ratio $m : n$ internally, is given by $\frac{n\vec{a} + m\vec{b}}{m + n}$

(ii) in the ratio $m : n$ externally, is given by $\frac{m\vec{b} - n\vec{a}}{m - n}$

10.1.11 Projection of \vec{a} along \vec{b} is $\frac{\vec{a} \cdot \vec{b}}{|\vec{b}|}$ and the Projection vector of \vec{a} along \vec{b}

$$\text{is } \left(\frac{\vec{a} \cdot \vec{b}}{|\vec{b}|} \right) \vec{b}.$$

10.1.12 Scalar or dot product

The scalar or dot product of two given vectors \vec{a} and \vec{b} having an angle θ between them is defined as

$$\vec{a} \cdot \vec{b} = |\vec{a}| |\vec{b}| \cos \theta$$

10.1.13 Vector or cross product

The cross product of two vectors \vec{a} and \vec{b} having angle θ between them is given as

$$\vec{a} \times \vec{b} = |\vec{a}| |\vec{b}| \sin \theta \hat{n},$$

where \hat{n} is a unit vector perpendicular to the plane containing \vec{a} and \vec{b} and $\vec{a}, \vec{b}, \hat{n}$ form a right handed system.

10.1.14 If $\vec{a} = a_1\hat{i} + a_2\hat{j} + a_3\hat{k}$ and $\vec{b} = b_1\hat{i} + b_2\hat{j} + b_3\hat{k}$ are two vectors and λ is any scalar, then

$$\vec{a} + \vec{b} = (a_1 + b_1)\hat{i} + (a_2 + b_2)\hat{j} + (a_3 + b_3)\hat{k}$$

$$\lambda \vec{a} = (\lambda a_1)\hat{i} + (\lambda a_2)\hat{j} + (\lambda a_3)\hat{k}$$

$$\vec{a} \cdot \vec{b} = a_1 b_1 + a_2 b_2 + a_3 b_3$$

$$\vec{a} \times \vec{b} = \begin{vmatrix} \hat{i} & \hat{j} & \hat{k} \\ a_1 & b_1 & c_1 \\ a_2 & b_2 & c_2 \end{vmatrix} = (b_1 c_2 - b_2 c_1)\hat{i} + (a_2 c_1 - c_1 c_2)\hat{j} + (a_1 b_2 - a_2 b_1)\hat{k}$$

Angle between two vectors \vec{a} and \vec{b} is given by

$$\cos \theta = \frac{\vec{a} \cdot \vec{b}}{|\vec{a}| |\vec{b}|} = \frac{a_1 b_1 + a_2 b_2 + a_3 b_3}{\sqrt{a_1^2 + a_2^2 + a_3^2} \sqrt{b_1^2 + b_2^2 + b_3^2}}$$

10.2 Solved Examples

Short Answer (S.A.)

Example 1 Find the unit vector in the direction of the sum of the vectors

$$\vec{a} = 2\hat{i} - \hat{j} + 2\hat{k} \text{ and } \vec{b} = -\hat{i} + \hat{j} + 3\hat{k}.$$

Solution Let \vec{c} denote the sum of \vec{a} and \vec{b} . We have

$$\vec{c} = (2\hat{i} - \hat{j} + 2\hat{k}) + (-\hat{i} + \hat{j} + 3\hat{k}) = \hat{i} + 5\hat{k}$$

$$\text{Now } |\vec{c}| = \sqrt{1^2 + 5^2} = \sqrt{26}.$$

Thus, the required unit vector is $\hat{c} = \frac{\vec{c}}{|\vec{c}|} = \frac{1}{\sqrt{26}}(\hat{i} + 5\hat{k}) = \frac{1}{\sqrt{26}}\hat{i} + \frac{5}{\sqrt{26}}\hat{k}$.

Example 2 Find a vector of magnitude 11 in the direction opposite to that of \overline{PQ} , where P and Q are the points (1, 3, 2) and (-1, 0, 8), respectively.

Solution The vector with initial point P (1, 3, 2) and terminal point Q (-1, 0, 8) is given by

$$\overline{PQ} = (-1 - 1)\hat{i} + (0 - 3)\hat{j} + (8 - 2)\hat{k} = -2\hat{i} - 3\hat{j} + 6\hat{k}$$

Thus $\overline{QP} = -\overline{PQ} = 2\hat{i} + 3\hat{j} - 6\hat{k}$

$$\Rightarrow |\overline{QP}| = \sqrt{2^2 + 3^2 + (-6)^2} = \sqrt{4 + 9 + 36} = \sqrt{49} = 7$$

Therefore, unit vector in the direction of \overline{QP} is given by

$$\widehat{QP} = \frac{\overline{QP}}{|\overline{QP}|} = \frac{2\hat{i} + 3\hat{j} - 6\hat{k}}{7}$$

Hence, the required vector of magnitude 11 in direction of \overline{QP} is

$$11 \widehat{QP} = 11 \frac{2\hat{i} + 3\hat{j} - 6\hat{k}}{7} = \frac{22}{7}\hat{i} + \frac{33}{7}\hat{j} - \frac{66}{7}\hat{k}$$

Example 3 Find the position vector of a point R which divides the line joining the two points P and Q with position vectors $\overline{OP} = 2\vec{a} - \vec{b}$ and $\overline{OQ} = \vec{a} - 2\vec{b}$, respectively, in the ratio 1:2, (i) internally and (ii) externally.

Solution (i) The position vector of the point R dividing the join of P and Q internally in the ratio 1:2 is given by

$$\overline{OR} = \frac{2(2\vec{a} - \vec{b}) + 1(\vec{a} - 2\vec{b})}{1 + 2} = \frac{5\vec{a}}{3}$$

- (ii) The position vector of the point R' dividing the join of P and Q in the ratio 1 : 2 externally is given by

$$\overrightarrow{OR'} = \frac{2(2\bar{a} + \bar{b}) - 1(\bar{a} - 2\bar{b})}{2 - 1} = 3\bar{a} + 4\bar{b}.$$

Example 4 If the points $(-1, -1, 2)$, $(2, m, 5)$ and $(3, 11, 6)$ are collinear, find the value of m .

Solution Let the given points be A $(-1, -1, 2)$, B $(2, m, 5)$ and C $(3, 11, 6)$. Then

$$\overrightarrow{AB} = (2+1)\hat{i} + (m+1)\hat{j} + (5-2)\hat{k} = 3\hat{i} + (m+1)\hat{j} + 3\hat{k}$$

and
$$\overrightarrow{AC} = (3+1)\hat{i} + (11+1)\hat{j} + (6-2)\hat{k} = 4\hat{i} + 12\hat{j} + 4\hat{k}.$$

Since A, B, C, are collinear, we have $\overrightarrow{AB} = \lambda \overrightarrow{AC}$, i.e.,

$$(3\hat{i} + (m+1)\hat{j} + 3\hat{k}) = \lambda(4\hat{i} + 12\hat{j} + 4\hat{k})$$

$$\Rightarrow 3 = 4\lambda \text{ and } m+1 = 12\lambda$$

Therefore $m = 8$.

Example 5 Find a vector \vec{r} of magnitude $3\sqrt{2}$ units which makes an angle of $\frac{\pi}{4}$ and $\frac{\pi}{2}$ with y and z - axes, respectively.

Solution Here $m = \cos \frac{\pi}{4} = \frac{1}{\sqrt{2}}$ and $n = \cos \frac{\pi}{2} = 0$.

Therefore, $l^2 + m^2 + n^2 = 1$ gives

$$l^2 + \frac{1}{2} + 0 = 1$$

$$\Rightarrow l = \pm \frac{1}{\sqrt{2}}$$

Hence, the required vector $\vec{r} = 3\sqrt{2} (l\hat{i} + m\hat{j} + n\hat{k})$ is given by

$$\vec{r} = 3\sqrt{2} \left(\frac{1}{\sqrt{2}}\hat{i} - \frac{1}{\sqrt{2}}\hat{j} + 0\hat{k} \right) = \vec{r} = \pm 3\hat{i} + 3\hat{j}.$$

Example 6 If $\vec{a} = 2\hat{i} - \hat{j} + \hat{k}$, $\vec{b} = \hat{i} + \hat{j} - 2\hat{k}$ and $\vec{c} = \hat{i} + 3\hat{j} - \hat{k}$, find λ such that \vec{a} is perpendicular to $\vec{b} + \vec{c}$.

Solution We have

$$\begin{aligned} \lambda \vec{b} + \vec{c} &= \lambda (\hat{i} + \hat{j} - 2\hat{k}) + (\hat{i} + 3\hat{j} - \hat{k}) \\ &= (\lambda + 1)\hat{i} + (\lambda + 3)\hat{j} - (2\lambda + 1)\hat{k} \end{aligned}$$

Since $\vec{a} \perp (\lambda \vec{b} + \vec{c})$, $\vec{a} \cdot (\lambda \vec{b} + \vec{c}) = 0$

$$\begin{aligned} &\Rightarrow (2\hat{i} - \hat{j} + \hat{k}) \cdot [(\lambda + 1)\hat{i} + (\lambda + 3)\hat{j} - (2\lambda + 1)\hat{k}] = 0 \\ &\Rightarrow 2(\lambda + 1) - (\lambda + 3) - (2\lambda + 1) = 0 \\ &\Rightarrow \lambda = -2. \end{aligned}$$

Example 7 Find all vectors of magnitude $10\sqrt{3}$ that are perpendicular to the plane of $\hat{i} + 2\hat{j} + \hat{k}$ and $\hat{i} + 3\hat{j} + 4\hat{k}$.

Solution Let $\vec{a} = \hat{i} + 2\hat{j} + \hat{k}$ and $\vec{b} = \hat{i} + 3\hat{j} + 4\hat{k}$. Then

$$\vec{a} \times \vec{b} = \begin{vmatrix} \hat{i} & \hat{j} & \hat{k} \\ 1 & 2 & 1 \\ -1 & 3 & 4 \end{vmatrix} = \hat{i}(8 - 3) - \hat{j}(4 - 1) + \hat{k}(3 - 2) = 5\hat{i} - 5\hat{j} + 5\hat{k}$$

$$\Rightarrow |\vec{a} \times \vec{b}| = \sqrt{(5)^2 + (-5)^2 + (5)^2} = \sqrt{3(5)^2} = 5\sqrt{3}.$$

Therefore, unit vector perpendicular to the plane of \vec{a} and \vec{b} is given by

$$\frac{\vec{a} \times \vec{b}}{|\vec{a} \times \vec{b}|} = \frac{5\hat{i} - 5\hat{j} + 5\hat{k}}{5\sqrt{3}}$$

Hence, vectors of magnitude of $10\sqrt{3}$ that are perpendicular to plane of \vec{a} and \vec{b}

are $10\sqrt{3} \frac{5\hat{i} - 5\hat{j} + 5\hat{k}}{5\sqrt{3}}$, i.e., $10(\hat{i} - \hat{j} + \hat{k})$.

Long Answer (L.A.)

Example 8 Using vectors, prove that $\cos(A - B) = \cos A \cos B + \sin A \sin B$.

Solution Let \widehat{OP} and \widehat{OQ} be unit vectors making angles A and B , respectively, with positive direction of x -axis. Then $\angle QOP = A - B$ [Fig. 10.1]

We know $\widehat{OP} = \overline{OM} + \overline{MP} = \hat{i} \cos A + \hat{j} \sin A$ and $\widehat{OQ} = \overline{ON} + \overline{NQ} = \hat{i} \cos B + \hat{j} \sin B$.

By definition $\widehat{OP} \cdot \widehat{OQ} = |\widehat{OP}| |\widehat{OQ}| \cos(A - B)$

$$= \cos(A - B) \quad \dots (1) \quad \because |\widehat{OP}| = 1 = |\widehat{OQ}|$$

In terms of components, we have

$$\widehat{OP} \cdot \widehat{OQ} = (\hat{i} \cos A + \hat{j} \sin A) \cdot (\hat{i} \cos B + \hat{j} \sin B)$$

$$= \cos A \cos B + \sin A \sin B \quad \dots (2)$$

From (1) and (2), we get

$$\cos(A - B) = \cos A \cos B + \sin A \sin B.$$

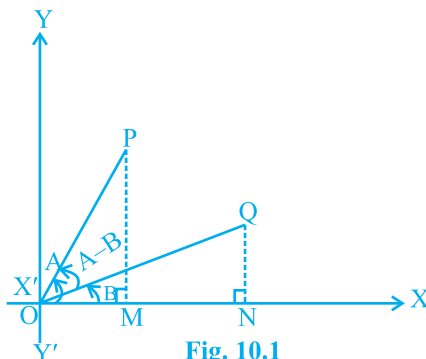

Fig. 10.1

Example 9 Prove that in a ΔABC , $\frac{\sin A}{a} = \frac{\sin B}{b} = \frac{\sin C}{c}$, where a, b, c represent the magnitudes of the sides opposite to vertices A, B, C, respectively.

Solution Let the three sides of the triangle BC, CA and AB be represented by \vec{a}, \vec{b} and \vec{c} , respectively [Fig. 10.2].

We have $\vec{a} + \vec{b} + \vec{c} = \vec{0}$. i.e., $\vec{a} + \vec{b} = -\vec{c}$

which pre cross multiplying by \vec{a} , and

post cross multiplying by \vec{b} , gives

$$\vec{a} \times \vec{b} = \vec{c} \times \vec{a}$$

and $\vec{a} + \vec{b} = -\vec{c}$

respectively. Therefore,

$$\vec{a} + \vec{b} = -\vec{c} \quad \vec{c} \times \vec{a}$$

$$\Rightarrow |\vec{a} + \vec{b}| |\vec{c}| \sin C = |\vec{c}| |\vec{a}| \sin A$$

$$\Rightarrow |\vec{a}| |\vec{b}| \sin(\pi - C) + |\vec{b}| |\vec{c}| \sin(\pi - A) = |\vec{c}| |\vec{a}| \sin(\pi - B)$$

$$\Rightarrow ab \sin C = bc \sin A = ca \sin B$$

Dividing by abc , we get

$$\frac{\sin C}{c} = \frac{\sin A}{a} = \frac{\sin B}{b} \text{ i.e. } \frac{\sin A}{a} = \frac{\sin B}{b} = \frac{\sin C}{c}$$

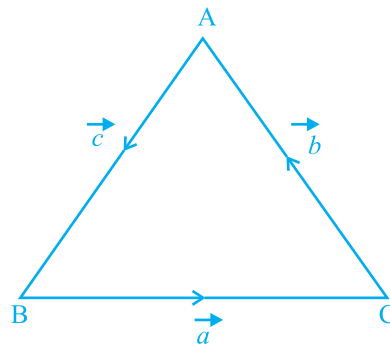

Fig. 10.2

Objective Type Questions

Choose the correct answer from the given four options in each of the Examples 10 to 21.

Example 10 The magnitude of the vector $6\hat{i} + 2\hat{j} + 3\hat{k}$ is

- (A) 5 (B) 7 (C) 12 (D) 1

Solution (B) is the correct answer.

Example 11 The position vector of the point which divides the join of points with position vectors \vec{a} \vec{b} and $2\vec{a}$ \vec{b} in the ratio 1 : 2 is

- (A) $\frac{3\vec{a} - 2\vec{b}}{3}$ (B) \vec{a} (C) $\frac{5\vec{a} - \vec{b}}{3}$ (D) $\frac{4\vec{a} - \vec{b}}{3}$

Solution (D) is the correct answer. Applying section formula the position vector of the required point is

$$\frac{2(\vec{a} - \vec{b}) + 1(2\vec{a} - \vec{b})}{2 + 1} = \frac{4\vec{a} - \vec{b}}{3}$$

Example 12 The vector with initial point P (2, -3, 5) and terminal point Q(3, -4, 7) is

- (A) $\hat{i} - \hat{j} + 2\hat{k}$ (B) $5\hat{i} - 7\hat{j} + 12\hat{k}$
 (C) $\hat{i} - \hat{j} + 2\hat{k}$ (D) None of these

Solution (A) is the correct answer.

Example 13 The angle between the vectors $\hat{i} - \hat{j}$ and $\hat{j} - \hat{k}$ is

- (A) $\frac{1}{3}$ (B) $\frac{2}{3}$ (C) $\frac{1}{3}$ (D) $\frac{5}{6}$

Solution (B) is the correct answer. Apply the formula $\cos\theta = \frac{\vec{a} \cdot \vec{b}}{|\vec{a}| |\vec{b}|}$.

Example 14 The value of λ for which the two vectors $2\hat{i} - \hat{j} + 2\hat{k}$ and $3\hat{i} - \hat{j} - \hat{k}$ are perpendicular is

- (A) 2 (B) 4 (C) 6 (D) 8

Solution (D) is the correct answer.

Example 15 The area of the parallelogram whose adjacent sides are $\hat{i} \hat{k}$ and $2\hat{i} \hat{j} \hat{k}$ is

- (A) $\sqrt{2}$ (B) $\sqrt{3}$ (C) 3 (D) 4

Solution (B) is the correct answer. Area of the parallelogram whose adjacent sides are \vec{a} and \vec{b} is $|\vec{a} \times \vec{b}|$.

Example 16 If $|\vec{a}| = 8$, $|\vec{b}| = 3$ and $|\vec{a} \cdot \vec{b}| = 12$, then value of $\vec{a} \cdot \vec{b}$ is

- (A) $6\sqrt{3}$ (B) $8\sqrt{3}$ (C) $12\sqrt{3}$ (D) None of these

Solution (C) is the correct answer. Using the formula $|\vec{a} \cdot \vec{b}| = |\vec{a}| |\vec{b}| |\cos\theta|$, we get

$$\theta = \pm \frac{\pi}{6}$$

Therefore, $\vec{a} \cdot \vec{b} = |\vec{a}| |\vec{b}| \cos\theta = 8 \times 3 \times \frac{\sqrt{3}}{2} = 12\sqrt{3}$.

Example 17 The 2 vectors $\hat{j} + \hat{k}$ and $3\hat{i} - \hat{j} + 4\hat{k}$ represents the two sides AB and AC, respectively of a ΔABC . The length of the median through A is

- (A) $\frac{\sqrt{34}}{2}$ (B) $\frac{\sqrt{48}}{2}$ (C) $\sqrt{18}$ (D) None of these

Solution (A) is the correct answer. Median \overline{AD} is given by

$$|\overline{AD}| = \frac{1}{2} |3\hat{i} + \hat{j} + 5\hat{k}| = \frac{\sqrt{34}}{2}$$

Example 18 The projection of vector $\vec{a} = 2\hat{i} \hat{j} \hat{k}$ along $\vec{b} = \hat{i} + 2\hat{j} + 2\hat{k}$ is

- (A) $\frac{2}{3}$ (B) $\frac{1}{3}$ (C) 2 (D) $\sqrt{6}$

Solution (A) is the correct answer. Projection of a vector \vec{a} on \vec{b} is

$$\frac{\vec{a} \cdot \vec{b}}{|\vec{b}|} = \frac{(2\hat{i} + \hat{j} + \hat{k}) \cdot (\hat{i} + 2\hat{j} + 2\hat{k})}{\sqrt{1 + 4 + 4}} = \frac{2}{3}$$

Example 19 If \vec{a} and \vec{b} are unit vectors, then what is the angle between \vec{a} and \vec{b} for $\sqrt{3}\vec{a} + \vec{b}$ to be a unit vector?

- (A) 30° (B) 45° (C) 60° (D) 90°

Solution (A) is the correct answer. We have

$$\begin{aligned} (\sqrt{3}\vec{a} + \vec{b})^2 &= 3\vec{a}^2 + \vec{b}^2 + 2\sqrt{3}\vec{a} \cdot \vec{b} \\ \Rightarrow \vec{a} \cdot \vec{b} &= \frac{\sqrt{3}}{2} \Rightarrow \cos\theta = \frac{\sqrt{3}}{2} \quad \theta = 30^\circ. \end{aligned}$$

Example 20 The unit vector perpendicular to the vectors $\hat{i} + \hat{j}$ and $\hat{i} - \hat{j}$ forming a right handed system is

- (A) \hat{k} (B) $-\hat{k}$ (C) $\frac{\hat{i} + \hat{j}}{\sqrt{2}}$ (D) $\frac{\hat{i} - \hat{j}}{\sqrt{2}}$

Solution (A) is the correct answer. Required unit vector is $\frac{\hat{i} + \hat{j} + \hat{i} - \hat{j}}{|\hat{i} + \hat{j} + \hat{i} - \hat{j}|} = \frac{2\hat{k}}{2} = \hat{k}$.

Example 21 If $|\vec{a}| = 3$ and $|\vec{b}| = 2$, then $|\vec{a} \times \vec{b}|$ lies in the interval

- (A) $[0, 6]$ (B) $[-3, 6]$ (C) $[3, 6]$ (D) $[1, 2]$

Solution (A) is the correct answer. The smallest value of $|k\vec{a}|$ will exist at numerically smallest value of k , i.e., at $k = 0$, which gives $|k\vec{a}| = |k||\vec{a}| = 0 \cdot 3 = 0$

The numerically greatest value of k is 2 at which $|k\vec{a}| = 6$.

10.3 EXERCISE

Short Answer (S.A.)

- Find the unit vector in the direction of sum of vectors $\vec{a} = 2\hat{i} + \hat{j} + \hat{k}$ and $\vec{b} = 2\hat{j} + \hat{k}$.
- If $\vec{a} = \hat{i} + \hat{j} + 2\hat{k}$ and $\vec{b} = 2\hat{i} + \hat{j} + 2\hat{k}$, find the unit vector in the direction of
 - $6\vec{b}$
 - $2\vec{a} - \vec{b}$
- Find a unit vector in the direction of \overline{PQ} , where P and Q have co-ordinates (5, 0, 8) and (3, 3, 2), respectively.
- If \vec{a} and \vec{b} are the position vectors of A and B, respectively, find the position vector of a point C in BA produced such that $BC = 1.5 BA$.
- Using vectors, find the value of k such that the points $(k, -10, 3)$, $(1, -1, 3)$ and $(3, 5, 3)$ are collinear.
- A vector \vec{r} is inclined at equal angles to the three axes. If the magnitude of \vec{r} is $2\sqrt{3}$ units, find \vec{r} .
- A vector \vec{r} has magnitude 14 and direction ratios 2, 3, -6. Find the direction cosines and components of \vec{r} , given that \vec{r} makes an acute angle with x -axis.
- Find a vector of magnitude 6, which is perpendicular to both the vectors $2\hat{i} + \hat{j} + 2\hat{k}$ and $4\hat{i} - \hat{j} + 3\hat{k}$.
- Find the angle between the vectors $2\hat{i} + \hat{j} + \hat{k}$ and $3\hat{i} + 4\hat{j} + \hat{k}$.
- If $\vec{a} \cdot \vec{b} = \vec{c} \cdot 0$, show that $\vec{a} \cdot \vec{b} = \vec{b} \cdot \vec{c} = \vec{c} \cdot \vec{a}$. Interpret the result geometrically?
- Find the sine of the angle between the vectors $\vec{a} = 3\hat{i} + \hat{j} + 2\hat{k}$ and $\vec{b} = 2\hat{i} + 2\hat{j} + 4\hat{k}$.

12. If A, B, C, D are the points with position vectors $\hat{i} \hat{j} \hat{k}$, $2\hat{i} \hat{j} 3\hat{k}$, $2\hat{i} 3\hat{k}$, $3\hat{i} 2\hat{j} \hat{k}$, respectively, find the projection of \overline{AB} along \overline{CD} .
13. Using vectors, find the area of the triangle ABC with vertices A(1, 2, 3), B(2, -1, 4) and C(4, 5, -1).
14. Using vectors, prove that the parallelogram on the same base and between the same parallels are equal in area.

Long Answer (L.A.)

15. Prove that in any triangle ABC, $\cos A = \frac{b^2 + c^2 - a^2}{2bc}$, where a, b, c are the magnitudes of the sides opposite to the vertices A, B, C, respectively.
16. If $\vec{a}, \vec{b}, \vec{c}$ determine the vertices of a triangle, show that $\frac{1}{2} \vec{b} \times \vec{c} + \vec{c} \times \vec{a} + \vec{a} \times \vec{b}$ gives the vector area of the triangle. Hence deduce the condition that the three points $\vec{a}, \vec{b}, \vec{c}$ are collinear. Also find the unit vector normal to the plane of the triangle.
17. Show that area of the parallelogram whose diagonals are given by \vec{a} and \vec{b} is $\frac{|\vec{a} \times \vec{b}|}{2}$. Also find the area of the parallelogram whose diagonals are $2\hat{i} \hat{j} \hat{k}$ and $\hat{i} 3\hat{j} \hat{k}$.
18. If $\vec{a} = \hat{i} \hat{j} \hat{k}$ and $\vec{b} = \hat{j} \hat{k}$, find a vector \vec{c} such that $\vec{a} \times \vec{c} = \vec{b}$ and $\vec{a} \cdot \vec{c} = 3$.

Objective Type Questions

Choose the correct answer from the given four options in each of the Exercises from 19 to 33 (M.C.Q)

19. The vector in the direction of the vector $\hat{i} 2\hat{j} 2\hat{k}$ that has magnitude 9 is
- (A) $\hat{i} 2\hat{j} 2\hat{k}$ (B) $\frac{\hat{i} 2\hat{j} 2\hat{k}}{3}$
- (C) $3(\hat{i} 2\hat{j} 2\hat{k})$ (D) $9(\hat{i} 2\hat{j} 2\hat{k})$

20. The position vector of the point which divides the join of points $2\vec{a} + 3\vec{b}$ and $\vec{a} + \vec{b}$ in the ratio 3 : 1 is
- (A) $\frac{3\vec{a} + 2\vec{b}}{2}$ (B) $\frac{7\vec{a} + 8\vec{b}}{4}$ (C) $\frac{3\vec{a}}{4}$ (D) $\frac{5\vec{a}}{4}$
21. The vector having initial and terminal points as (2, 5, 0) and (-3, 7, 4), respectively is
- (A) $\hat{i} + 12\hat{j} + 4\hat{k}$ (B) $5\hat{i} + 2\hat{j} + 4\hat{k}$
 (C) $5\hat{i} + 2\hat{j} + 4\hat{k}$ (D) $\hat{i} + \hat{j} + \hat{k}$
22. The angle between two vectors \vec{a} and \vec{b} with magnitudes $\sqrt{3}$ and 4, respectively, and $\vec{a} \cdot \vec{b} = 2\sqrt{3}$ is
- (A) $\frac{\pi}{6}$ (B) $\frac{\pi}{3}$ (C) $\frac{\pi}{2}$ (D) $\frac{5\pi}{2}$
23. Find the value of λ such that the vectors $\vec{a} = 2\hat{i} + \hat{j} + \hat{k}$ and $\vec{b} = \hat{i} + 2\hat{j} + 3\hat{k}$ are orthogonal
- (A) 0 (B) 1 (C) $\frac{3}{2}$ (D) $-\frac{5}{2}$
24. The value of λ for which the vectors $3\hat{i} + 6\hat{j} + \hat{k}$ and $2\hat{i} + 4\hat{j} + \hat{k}$ are parallel is
- (A) $\frac{2}{3}$ (B) $\frac{3}{2}$ (C) $\frac{5}{2}$ (D) $\frac{2}{5}$
25. The vectors from origin to the points A and B are $\vec{a} = 2\hat{i} + 3\hat{j} + 2\hat{k}$ and $\vec{b} = 2\hat{i} + 3\hat{j} + \hat{k}$, respectively, then the area of triangle OAB is
- (A) 340 (B) $\sqrt{25}$ (C) $\sqrt{229}$ (D) $\frac{1}{2}\sqrt{229}$

26. For any vector \vec{a} , the value of $(\vec{a} \cdot \hat{i})^2 + (\vec{a} \cdot \hat{j})^2 + (\vec{a} \cdot \hat{k})^2$ is equal to
 (A) \vec{a}^2 (B) $3\vec{a}^2$ (C) $4\vec{a}^2$ (D) $2\vec{a}^2$
27. If $|\vec{a}| = 10$, $|\vec{b}| = 2$ and $\vec{a} \cdot \vec{b} = 12$, then value of $|\vec{a} - \vec{b}|$ is
 (A) 5 (B) 10 (C) 14 (D) 16
28. The vectors $\hat{i} + \hat{j} + 2\hat{k}$, $\hat{i} + \hat{j} + \hat{k}$ and $2\hat{i} + \hat{j} + \hat{k}$ are coplanar if
 (A) $\lambda = -2$ (B) $\lambda = 0$ (C) $\lambda = 1$ (D) $\lambda = -1$
29. If $\vec{a}, \vec{b}, \vec{c}$ are unit vectors such that $\vec{a} + \vec{b} + \vec{c} = \vec{0}$, then the value of $\vec{a} \cdot \vec{b} + \vec{b} \cdot \vec{c} + \vec{c} \cdot \vec{a}$ is
 (A) 1 (B) 3 (C) $-\frac{3}{2}$ (D) None of these
30. Projection vector of \vec{a} on \vec{b} is
 (A) $\frac{\vec{a} \cdot \vec{b}}{|\vec{b}|^2} \vec{b}$ (B) $\frac{\vec{a} \cdot \vec{b}}{|\vec{b}|}$ (C) $\frac{\vec{a} \cdot \vec{b}}{|\vec{a}|}$ (D) $\frac{\vec{a} \cdot \vec{b}}{|\vec{a}|^2} \hat{b}$
31. If $\vec{a}, \vec{b}, \vec{c}$ are three vectors such that $\vec{a} + \vec{b} + \vec{c} = \vec{0}$ and $|\vec{a}| = 2$, $|\vec{b}| = 3$, $|\vec{c}| = 5$, then value of $\vec{a} \cdot \vec{b} + \vec{b} \cdot \vec{c} + \vec{c} \cdot \vec{a}$ is
 (A) 0 (B) 1 (C) -19 (D) 38
32. If $|\vec{a}| = 4$ and $|\vec{b}| = 3$, then the range of $|\vec{a} - \vec{b}|$ is
 (A) $[0, 8]$ (B) $[-12, 8]$ (C) $[0, 12]$ (D) $[8, 12]$
33. The number of vectors of unit length perpendicular to the vectors $\vec{a} = 2\hat{i} + \hat{j} + 2\hat{k}$ and $\vec{b} = \hat{j} + \hat{k}$ is
 (A) one (B) two (C) three (D) infinite

Fill in the blanks in each of the Exercises from 34 to 40.

34. The vector $\vec{a} + \vec{b}$ bisects the angle between the non-collinear vectors \vec{a} and \vec{b} if _____

35. If $\vec{r} \cdot \vec{a} = 0$, $\vec{r} \cdot \vec{b} = 0$, and $\vec{r} \cdot \vec{c} = 0$ for some non-zero vector \vec{r} , then the value of $\vec{a} \cdot (\vec{b} \times \vec{c})$ is _____.
36. The vectors $\vec{a} = 3\hat{i} + 2\hat{j} + 2\hat{k}$ and $\vec{b} = -\hat{i} + 2\hat{k}$ are the adjacent sides of a parallelogram. The acute angle between its diagonals is _____.
37. The values of k for which $|k\vec{a}| = |\vec{a}|$ and $k\vec{a} = \frac{1}{2}\vec{a}$ is parallel to \vec{a} holds true are _____.
38. The value of the expression $|\vec{a} \times \vec{b}|^2 + (\vec{a} \cdot \vec{b})^2$ is _____.
39. If $|\vec{a} + \vec{b}|^2 + |\vec{a} - \vec{b}|^2 = 144$ and $|\vec{a}| = 4$, then $|\vec{b}|$ is equal to _____.
40. If \vec{a} is any non-zero vector, then $(\vec{a} \cdot \hat{i})\hat{i} + (\vec{a} \cdot \hat{j})\hat{j} + (\vec{a} \cdot \hat{k})\hat{k}$ equals _____.

State **True** or **False** in each of the following Exercises.

41. If $|\vec{a}| = |\vec{b}|$, then necessarily it implies $\vec{a} = \vec{b}$.
42. Position vector of a point P is a vector whose initial point is origin.
43. If $|\vec{a} + \vec{b}| = |\vec{a} - \vec{b}|$, then the vectors \vec{a} and \vec{b} are orthogonal.
44. The formula $(\vec{a} + \vec{b})^2 = \vec{a}^2 + \vec{b}^2 + 2\vec{a} \cdot \vec{b}$ is valid for non-zero vectors \vec{a} and \vec{b} .
45. If \vec{a} and \vec{b} are adjacent sides of a rhombus, then $\vec{a} \cdot \vec{b} = 0$.



THREE DIMENSIONAL GEOMETRY**11.1 Overview**

11.1.1 Direction cosines of a line are the cosines of the angles made by the line with positive directions of the co-ordinate axes.

11.1.2 If l, m, n are the direction cosines of a line, then $l^2 + m^2 + n^2 = 1$

11.1.3 Direction cosines of a line joining two points $P(x_1, y_1, z_1)$ and $Q(x_2, y_2, z_2)$ are

$$\frac{x_2 - x_1}{PQ}, \frac{y_2 - y_1}{PQ}, \frac{z_2 - z_1}{PQ},$$

where $PQ = \sqrt{(x_2 - x_1)^2 + (y_2 - y_1)^2 + (z_2 - z_1)^2}$

11.1.4 Direction ratios of a line are the numbers which are proportional to the direction cosines of the line.

11.1.5 If l, m, n are the direction cosines and a, b, c are the direction ratios of a line,

$$\text{then } l = \frac{a}{\sqrt{a^2 + b^2 + c^2}}; m = \frac{b}{\sqrt{a^2 + b^2 + c^2}}; n = \frac{c}{\sqrt{a^2 + b^2 + c^2}}$$

11.1.6 Skew lines are lines in the space which are neither parallel nor intersecting. They lie in the different planes.

11.1.7 Angle between skew lines is the angle between two intersecting lines drawn from any point (preferably through the origin) parallel to each of the skew lines.

11.1.8 If l_1, m_1, n_1 and l_2, m_2, n_2 are the direction cosines of two lines and θ is the acute angle between the two lines, then

$$\cos\theta = |l_1l_2 + m_1m_2 + n_1n_2|$$

11.1.9 If a_1, b_1, c_1 and a_2, b_2, c_2 are the directions ratios of two lines and θ is the acute angle between the two lines, then

$$\cos \theta = \left| \frac{a_1 a_2 + b_1 b_2 + c_1 c_2}{\sqrt{a_1^2 + a_2^2 + a_3^2} \cdot \sqrt{b_1^2 + b_2^2 + b_3^2}} \right|$$

11.1.10 Vector equation of a line that passes through the given point whose position vector is \vec{a} and parallel to a given vector \vec{b} is $\vec{r} = \vec{a} + \lambda \vec{b}$.

11.1.11 Equation of a line through a point (x_1, y_1, z_1) and having directions cosines l, m, n (or, direction ratios a, b and c) is

$$\frac{x-x_1}{l} = \frac{y-y_1}{m} = \frac{z-z_1}{n} \quad \text{or} \quad \left(\frac{x-x_1}{a} = \frac{y-y_1}{b} = \frac{z-z_1}{c} \right).$$

11.1.12 The vector equation of a line that passes through two points whose position vectors are \vec{a} and \vec{b} is $\vec{r} = \vec{a} + \lambda(\vec{b} - \vec{a})$.

11.1.13 Cartesian equation of a line that passes through two points (x_1, y_1, z_1) and (x_2, y_2, z_2) is

$$\frac{x-x_1}{x_2-x_1} = \frac{y-y_1}{y_2-y_1} = \frac{z-z_1}{z_2-z_1}$$

11.1.14 If θ is the acute angle between the lines $\vec{r} = \vec{a}_1 + \lambda \vec{b}_1$ and $\vec{r} = \vec{a}_2 + \lambda \vec{b}_2$, then

$$\theta \text{ is given by } \cos \theta = \frac{|\vec{b}_1 \cdot \vec{b}_2|}{|\vec{b}_1| |\vec{b}_2|} \quad \text{or} \quad \theta = \cos^{-1} \frac{|\vec{b}_1 \cdot \vec{b}_2|}{|\vec{b}_1| |\vec{b}_2|}.$$

11.1.15 If $\frac{x-x_1}{l_1} = \frac{y-y_1}{m_1} = \frac{z-z_1}{n_1}$ and $\frac{x-x_2}{l_2} = \frac{y-y_2}{m_2} = \frac{z-z_2}{n_2}$ are equations of two lines, then the acute angle θ between the two lines is given by $\cos \theta = \frac{|l_1 l_2 + m_1 m_2 + n_1 n_2|}{\sqrt{l_1^2 + m_1^2 + n_1^2} \sqrt{l_2^2 + m_2^2 + n_2^2}}$.

11.1.16 The shortest distance between two skew lines is the length of the line segment perpendicular to both the lines.

11.1.17 The shortest distance between the lines $\vec{r} = \vec{a}_1 + \lambda \vec{b}_1$ and $\vec{r} = \vec{a}_2 + \lambda \vec{b}_2$ is

$$\left| \frac{\vec{b}_1 \cdot \vec{b}_2 \cdot \vec{a}_2 - \vec{a}_1}{|\vec{b}_1 \cdot \vec{b}_2|} \right|$$

11.1.18 Shortest distance between the lines: $\frac{x-x_1}{a_1} = \frac{y-y_1}{b_1} = \frac{z-z_1}{c_1}$ and

$$\frac{x-x_2}{a_2} = \frac{y-y_2}{b_2} = \frac{z-z_2}{c_2} \text{ is}$$

$$\frac{\begin{vmatrix} x_2-x_1 & y_2-y_1 & z_2-z_1 \\ a_1 & b_1 & c_1 \\ a_2 & b_2 & c_2 \end{vmatrix}}{\sqrt{(b_1c_2-b_2c_1)^2 + (c_1a_2-c_2a_1)^2 + (a_1b_2-a_2b_1)^2}}$$

11.1.19 Distance between parallel lines $\vec{r} = \vec{a}_1 + \lambda \vec{b}$ and $\vec{r} = \vec{a}_2 + \lambda \vec{b}$ is

$$\left| \frac{\vec{b} \cdot (\vec{a}_2 - \vec{a}_1)}{|\vec{b}|} \right|$$

11.1.20 The vector equation of a plane which is at a distance p from the origin, where \hat{n} is the unit vector normal to the plane, is $\vec{r} \cdot \hat{n} = p$.

11.1.21 Equation of a plane which is at a distance p from the origin with direction cosines of the normal to the plane as l, m, n is $lx + my + nz = p$.

11.1.22 The equation of a plane through a point whose position vector is \vec{a} and perpendicular to the vector \vec{n} is $(\vec{r} - \vec{a}) \cdot \vec{n} = 0$ or $\vec{r} \cdot \vec{n} = d$, where $d = \vec{a} \cdot \vec{n}$.

11.1.23 Equation of a plane perpendicular to a given line with direction ratios a, b, c and passing through a given point (x_1, y_1, z_1) is $a(x - x_1) + b(y - y_1) + c(z - z_1) = 0$.

11.1.24 Equation of a plane passing through three non-collinear points (x_1, y_1, z_1) , (x_2, y_2, z_2) and (x_3, y_3, z_3) is

$$\begin{vmatrix} x-x_1 & y-y_1 & z-z_1 \\ x_2-x_1 & y_2-y_1 & z_2-z_1 \\ x_3-x_1 & y_3-y_1 & z_3-z_1 \end{vmatrix} = 0$$

11.1.25 Vector equation of a plane that contains three non-collinear points having position vectors \vec{a} , \vec{b} , \vec{c} is $(\vec{r}-\vec{a}) \cdot [(\vec{b}-\vec{a}) \times (\vec{c}-\vec{a})] = 0$

11.1.26 Equation of a plane that cuts the co-ordinates axes at $(a, 0, 0)$, $(0, b, 0)$ and $(0, 0, c)$ is $\frac{x}{a} + \frac{y}{b} + \frac{z}{c} = 1$.

11.1.27 Vector equation of any plane that passes through the intersection of planes $\vec{r} \cdot \vec{n}_1 = d_1$ and $\vec{r} \cdot \vec{n}_2 = d_2$ is $(\vec{r} \cdot \vec{n}_1 - d_1) + \lambda(\vec{r} \cdot \vec{n}_2 - d_2) = 0$, where λ is any non-zero constant.

11.1.28 Cartesian equation of any plane that passes through the intersection of two given planes $A_1x + B_1y + C_1z + D_1 = 0$ and $A_2x + B_2y + C_2z + D_2 = 0$ is $(A_1x + B_1y + C_1z + D_1) + \lambda (A_2x + B_2y + C_2z + D_2) = 0$.

11.1.29 Two lines $\vec{r} = \vec{a}_1 + \lambda \vec{b}_1$ and $\vec{r} = \vec{a}_2 + \lambda \vec{b}_2$ are coplanar if $(\vec{a}_2 - \vec{a}_1) \cdot (\vec{b}_1 \times \vec{b}_2) = 0$

11.1.30 Two lines $\frac{x-x_1}{a_1} = \frac{y-y_1}{b_1} = \frac{z-z_1}{c_1}$ and $\frac{x-x_2}{a_2} = \frac{y-y_2}{b_2} = \frac{z-z_2}{c_2}$ are coplanar if

$$\begin{vmatrix} x_2-x_1 & y_2-y_1 & z_2-z_1 \\ a_1 & b_1 & c_1 \\ a_2 & b_2 & c_2 \end{vmatrix} = 0,$$

11.1.31 In vector form, if θ is the acute angle between the two planes, $\vec{r} \cdot \vec{n}_1 = d_1$ and

$\vec{r} \cdot \vec{n}_2 = d_2$, then $\theta = \cos^{-1} \frac{|\vec{n}_1 \cdot \vec{n}_2|}{|\vec{n}_1| \cdot |\vec{n}_2|}$

11.1.32 The acute angle θ between the line $\vec{r} = \vec{a} + \lambda \vec{b}$ and plane $\vec{r} \cdot \vec{n} = d$ is given by

$$\sin \theta = \frac{|\vec{b} \cdot \vec{n}|}{|\vec{b}| \cdot |\vec{n}|}$$

11.2 Solved Examples

Short Answer (S.A.)

Example 1 If the direction ratios of a line are 1, 1, 2, find the direction cosines of the line.

Solution The direction cosines are given by

$$l = \frac{a}{\sqrt{a^2 + b^2 + c^2}}, m = \frac{b}{\sqrt{a^2 + b^2 + c^2}}, n = \frac{c}{\sqrt{a^2 + b^2 + c^2}}$$

Here a, b, c are 1, 1, 2, respectively.

$$\text{Therefore, } l = \frac{1}{\sqrt{1^2 + 1^2 + 2^2}}, m = \frac{1}{\sqrt{1^2 + 1^2 + 2^2}}, n = \frac{2}{\sqrt{1^2 + 1^2 + 2^2}}$$

i.e., $l = \frac{1}{\sqrt{6}}, m = \frac{1}{\sqrt{6}}, n = \frac{2}{\sqrt{6}}$ i.e. $\pm \left(\frac{1}{\sqrt{6}}, \frac{1}{\sqrt{6}}, \frac{2}{\sqrt{6}} \right)$ are D.C.'s of the line.

Example 2 Find the direction cosines of the line passing through the points P (2, 3, 5) and Q (-1, 2, 4).

Solution The direction cosines of a line passing through the points P (x_1, y_1, z_1) and Q (x_2, y_2, z_2) are

$$\frac{x_2 - x_1}{PQ}, \frac{y_2 - y_1}{PQ}, \frac{z_2 - z_1}{PQ}$$

$$\text{Here } PQ = \sqrt{(x_2 - x_1)^2 + (y_2 - y_1)^2 + (z_2 - z_1)^2}$$

$$= \sqrt{(-1 - 2)^2 + (2 - 3)^2 + (4 - 5)^2} = \sqrt{9 + 1 + 1} = \sqrt{11}$$

Hence D.C.'s are

$$\pm \left(\frac{-3}{\sqrt{11}}, \frac{-1}{\sqrt{11}}, \frac{-1}{\sqrt{11}} \right) \text{ or } \pm \left(\frac{3}{\sqrt{11}}, \frac{1}{\sqrt{11}}, \frac{1}{\sqrt{11}} \right).$$

Example 3 If a line makes an angle of 30° , 60° , 90° with the positive direction of x , y , z -axes, respectively, then find its direction cosines.

Solution The direction cosines of a line which makes an angle of α , β , γ with the axes, are $\cos\alpha$, $\cos\beta$, $\cos\gamma$

Therefore, D.C.'s of the line are $\cos 30^\circ$, $\cos 60^\circ$, $\cos 90^\circ$ i.e., $\pm \left(\frac{\sqrt{3}}{2}, \frac{1}{2}, 0 \right)$

Example 4 The x -coordinate of a point on the line joining the points Q (2, 2, 1) and R (5, 1, -2) is 4. Find its z -coordinate.

Solution Let the point P divide QR in the ratio $\lambda : 1$, then the co-ordinate of P are

$$\left(\frac{5\lambda+2}{\lambda+1}, \frac{\lambda+2}{\lambda+1}, \frac{-2\lambda+1}{\lambda+1} \right)$$

But x - coordinate of P is 4. Therefore,

$$\frac{5\lambda+2}{\lambda+1} = 4 \Rightarrow \lambda = 2$$

Hence, the z -coordinate of P is $\frac{-2\lambda+1}{\lambda+1} = -1$.

Example 5 Find the distance of the point whose position vector is $(2\hat{i} + \hat{j} - \hat{k})$ from the plane $\vec{r} \cdot (\hat{i} - 2\hat{j} + 4\hat{k}) = 9$

Solution Here $\vec{a} = 2\hat{i} + \hat{j} - \hat{k}$, $\vec{n} = \hat{i} - 2\hat{j} + 4\hat{k}$ and $d = 9$

So, the required distance is $\frac{|(2\hat{i} + \hat{j} - \hat{k}) \cdot (\hat{i} - 2\hat{j} + 4\hat{k}) - 9|}{\sqrt{1+4+16}}$

$$= \frac{|2-2-4-9|}{\sqrt{21}} = \frac{13}{\sqrt{21}}$$

Example 6 Find the distance of the point $(-2, 4, -5)$ from the line $\frac{x+3}{3} = \frac{y-4}{5} = \frac{z+8}{6}$

Solution Here $P(-2, 4, -5)$ is the given point.

Any point Q on the line is given by $(3\lambda - 3, 5\lambda + 4, (6\lambda - 8))$,

$$\overrightarrow{PQ} = (3\lambda - 1)\hat{i} + 5\lambda\hat{j} + (6\lambda - 3)\hat{k}$$

Since $\overrightarrow{PQ} \perp (3\hat{i} + 5\hat{j} + 6\hat{k})$, we have

$$3(3\lambda - 1) + 5(5\lambda) + 6(6\lambda - 3) = 0$$

$$9\lambda + 25\lambda + 36\lambda = 21, \text{ i.e. } \lambda = \frac{3}{10}$$

Thus
$$\overrightarrow{PQ} = -\frac{1}{10}\hat{i} + \frac{15}{10}\hat{j} - \frac{12}{10}\hat{k}$$

Hence
$$|\overrightarrow{PQ}| = \frac{1}{10}\sqrt{1+225+144} = \sqrt{\frac{37}{10}}$$

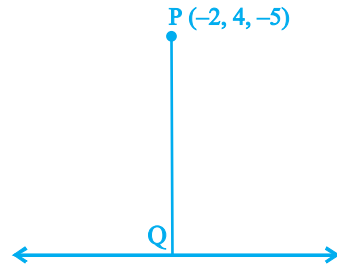

Fig. 11.1

Example 7 Find the coordinates of the point where the line through $(3, -4, -5)$ and $(2, -3, 1)$ crosses the plane passing through three points $(2, 2, 1)$, $(3, 0, 1)$ and $(4, -1, 0)$

Solution Equation of plane through three points $(2, 2, 1)$, $(3, 0, 1)$ and $(4, -1, 0)$ is

$$[(\vec{r} - (2\hat{i} + 2\hat{j} + \hat{k})) \cdot ((\hat{i} - 2\hat{j}) \times (\hat{i} - \hat{j} - \hat{k}))] = 0$$

i.e.
$$\vec{r} \cdot (2\hat{i} + \hat{j} + \hat{k}) = 7 \text{ or } 2x + y + z - 7 = 0 \dots (1)$$

Equation of line through $(3, -4, -5)$ and $(2, -3, 1)$ is

$$\frac{x-3}{-1} = \frac{y+4}{1} = \frac{z+5}{6} \dots (2)$$

Any point on line (2) is $(-\lambda + 3, \lambda - 4, 6\lambda - 5)$. This point lies on plane (1). Therefore, $2(-\lambda + 3) + (\lambda - 4) + (6\lambda - 5) - 7 = 0$, i.e., $\lambda = z$

Hence the required point is $(1, -2, 7)$.

Long Answer (L.A.)

Example 8 Find the distance of the point $(-1, -5, -10)$ from the point of intersection of the line $\vec{r} = 2\hat{i} - \hat{j} + 2\hat{k} + \lambda(3\hat{i} + 4\hat{j} + 2\hat{k})$ and the plane $\vec{r} \cdot (\hat{i} - \hat{j} + \hat{k}) = 5$.

Solution We have $\vec{r} = 2\hat{i} - \hat{j} + 2\hat{k} + \lambda(3\hat{i} + 4\hat{j} + 2\hat{k})$ and $\vec{r} \cdot (\hat{i} - \hat{j} + \hat{k}) = 5$

Solving these two equations, we get $[(2\hat{i} - \hat{j} + 2\hat{k}) + \lambda(3\hat{i} + 4\hat{j} + 2\hat{k})] \cdot (\hat{i} - \hat{j} + \hat{k}) = 5$

which gives $\lambda = 0$.

Therefore, the point of intersection of line and the plane is $(2, -1, 2)$ and the other given point is $(-1, -5, -10)$. Hence the distance between these two points is

$$\sqrt{2^2 + (-1)^2 + [2 - (-10)]^2}, \text{ i.e. } 13$$

Example 9 A plane meets the co-ordinates axis in A, B, C such that the centroid of the ΔABC is the point (α, β, γ) . Show that the equation of the plane is

$$\frac{x}{\alpha} + \frac{y}{\beta} + \frac{z}{\gamma} = 3$$

Solution Let the equation of the plane be

$$\frac{x}{a} + \frac{y}{b} + \frac{z}{c} = 1$$

Then the co-ordinate of A, B, C are $(a, 0, 0)$, $(0, b, 0)$ and $(0, 0, c)$ respectively. Centroid of the ΔABC is

$$\left(\frac{x_1 + x_2 + x_3}{3}, \frac{y_1 + y_2 + y_3}{3}, \frac{z_1 + z_2 + z_3}{3} \right) \text{ i.e. } \left(\frac{a}{3}, \frac{b}{3}, \frac{c}{3} \right)$$

But co-ordinates of the centroid of the ΔABC are (α, β, γ) (given).

Therefore, $\alpha = \frac{a}{3}, \beta = \frac{b}{3}, \gamma = \frac{c}{3}$, i.e. $a = 3\alpha, b = 3\beta, c = 3\gamma$

Thus, the equation of plane is

$$\frac{x}{\alpha} + \frac{y}{\beta} + \frac{z}{\gamma} = 3$$

Example 10 Find the angle between the lines whose direction cosines are given by the equations: $3l + m + 5n = 0$ and $6mn - 2nl + 5lm = 0$.

Solution Eliminating m from the given two equations, we get

$$\Rightarrow 2n^2 + 3ln + l^2 = 0$$

$$\Rightarrow (n + l)(2n + l) = 0$$

$$\Rightarrow \text{either } n = -l \text{ or } l = -2n$$

$$\text{Now if } l = -n, \text{ then } m = -2n$$

$$\text{and if } l = -2n, \text{ then } m = n.$$

Thus the direction ratios of two lines are proportional to $-n, -2n, n$ and $-2n, n, n$,
i.e. $1, 2, -1$ and $-2, 1, 1$.

So, vectors parallel to these lines are

$$\vec{a} = \hat{i} + 2\hat{j} - \hat{k} \quad \text{and} \quad \vec{b} = -2\hat{i} + \hat{j} + \hat{k}, \text{ respectively.}$$

If θ is the angle between the lines, then

$$\begin{aligned} \cos \theta &= \frac{\vec{a} \cdot \vec{b}}{|\vec{a}| |\vec{b}|} \\ &= \frac{(\hat{i} + 2\hat{j} - \hat{k}) \cdot (-2\hat{i} + \hat{j} + \hat{k})}{\sqrt{1^2 + 2^2 + (-1)^2} \sqrt{(-2)^2 + 1^2 + 1^2}} = -\frac{1}{6} \end{aligned}$$

$$\text{Hence } \theta = \cos^{-1} \left(-\frac{1}{6} \right)$$

Example 11 Find the co-ordinates of the foot of perpendicular drawn from the point A (1, 8, 4) to the line joining the points B (0, -1, 3) and C (2, -3, -1).

Solution Let L be the foot of perpendicular drawn from the points A (1, 8, 4) to the line passing through B and C as shown in the Fig. 11.2. The equation of line BC by using formula $\vec{r} = \vec{a} + \lambda (\vec{b} - \vec{a})$, the equation of the line BC is

$$\vec{r} = (-\hat{j} + 3\hat{k}) + \lambda(2\hat{i} - 2\hat{j} - 4\hat{k})$$

$$\Rightarrow \quad x\hat{i} \quad y\hat{j} \quad z\hat{k} = 2\hat{i} - 2\hat{j} - 4\hat{k} + \lambda(2\hat{i} - 2\hat{j} - 4\hat{k})$$

Comparing both sides, we get

$$x = 2\lambda, \quad y = -(2\lambda + 1), \quad z = 3 - 4\lambda \quad (1)$$

Thus, the co-ordinate of L are $(2\lambda, -(2\lambda + 1), 3 - 4\lambda)$,

so that the direction ratios of the line AL are $(1 - 2\lambda, 8 + (2\lambda + 1), 4 - (3 - 4\lambda))$, i.e.

$$1 - 2\lambda, \quad 2\lambda + 9, \quad 1 + 4\lambda$$

Since AL is perpendicular to BC, we have,

$$(1 - 2\lambda)(2 - 0) + (2\lambda + 9)(-3 + 1) + (4\lambda + 1)(-1 - 3) = 0$$

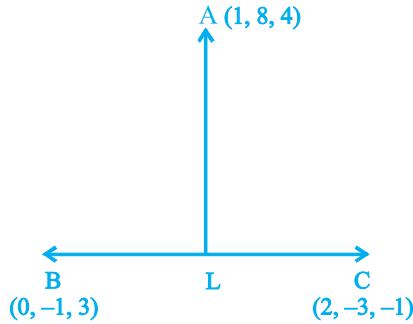

Fig.11.2

$$\Rightarrow \quad \lambda = \frac{-5}{6}$$

The required point is obtained by substituting the value of λ , in (1), which is

$$\left(\frac{-5}{3}, \frac{2}{3}, \frac{19}{3}\right).$$

Example 12 Find the image of the point $(1, 6, 3)$ in the line $\frac{x}{1} = \frac{y-1}{2} = \frac{z-2}{3}$.

Solution Let $P(1, 6, 3)$ be the given point and let L be the foot of perpendicular from P to the given line.

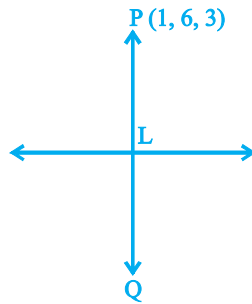

Fig.11.3

The coordinates of a general point on the given line are

$$\frac{x-0}{1} = \frac{y-1}{2} = \frac{z-2}{3}, \text{ i.e., } x = \lambda, y = 2\lambda + 1, z = 3\lambda + 2.$$

If the coordinates of L are $(\lambda, 2\lambda + 1, 3\lambda + 2)$, then the direction ratios of PL are $\lambda - 1, 2\lambda - 5, 3\lambda - 1$.

But the direction ratios of given line which is perpendicular to PL are $1, 2, 3$. Therefore, $(\lambda - 1)1 + (2\lambda - 5)2 + (3\lambda - 1)3 = 0$, which gives $\lambda = 1$. Hence coordinates of L are $(1, 3, 5)$.

Let $Q(x_1, y_1, z_1)$ be the image of $P(1, 6, 3)$ in the given line. Then L is the mid-point of PQ . Therefore,

$$\frac{x_1 + 1}{2} = 1, \frac{y_1 + 6}{2} = 3, \frac{z_1 + 3}{2} = 5$$

$$\Rightarrow x_1 = 1, y_1 = 0, z_1 = 7$$

Hence, the image of $(1, 6, 3)$ in the given line is $(1, 0, 7)$.

Example 13 Find the image of the point having position vector $\hat{i} + 3\hat{j} + 4\hat{k}$ in the plane $\hat{r} \cdot (2\hat{i} - \hat{j} + \hat{k}) = 3$.

Solution Let the given point be P $\hat{i} + 3\hat{j} + 4\hat{k}$ and Q be the image of P in the plane $\hat{r} \cdot (2\hat{i} - \hat{j} + \hat{k}) = 3$ as shown in the Fig. 11.4.

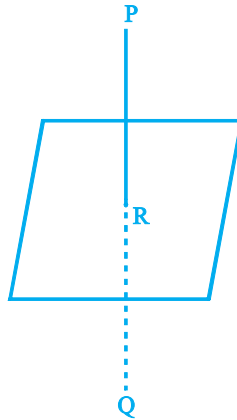

Fig.11.4

Then PQ is the normal to the plane. Since PQ passes through P and is normal to the given plane, so the equation of PQ is given by

$$\vec{r} = \hat{i} + 3\hat{j} + 4\hat{k} + \lambda(2\hat{i} - \hat{j} + \hat{k})$$

Since Q lies on the line PQ, the position vector of Q can be expressed as

$$\hat{i} + 3\hat{j} + 4\hat{k} + \lambda(2\hat{i} - \hat{j} + \hat{k}), \text{ i.e., } (1+2\lambda)\hat{i} + (3-\lambda)\hat{j} + (4+\lambda)\hat{k}$$

Since R is the mid point of PQ, the position vector of R is

$$\frac{[(1+2\lambda)\hat{i} + (3-\lambda)\hat{j} + (4+\lambda)\hat{k}] + [\hat{i} + 3\hat{j} + 4\hat{k}]}{2}$$

$$\text{i.e., } (\lambda+1)\hat{i} + \left(3 - \frac{\lambda}{2}\right)\hat{j} + \left(4 + \frac{\lambda}{2}\right)\hat{k}$$

Again, since R lies on the plane $\vec{r} \cdot (2\hat{i} - \hat{j} + \hat{k}) + 3 = 0$, we have

$$\left\{ (\lambda+1)\hat{i} + \left(3 - \frac{\lambda}{2}\right)\hat{j} + \left(4 + \frac{\lambda}{2}\right)\hat{k} \right\} \cdot (2\hat{i} - \hat{j} + \hat{k}) + 3 = 0$$

$$\Rightarrow \lambda = -2$$

Hence, the position vector of Q is $(\hat{i} + 3\hat{j} + 4\hat{k}) - 2(2\hat{i} - \hat{j} + \hat{k})$, i.e. $-\hat{i} + 5\hat{j} + 2\hat{k}$.

Objective Type Questions

Choose the correct answer from the given four options in each of the Examples 14 to 19.

Example 14 The coordinates of the foot of the perpendicular drawn from the point (2, 5, 7) on the x -axis are given by

- (A) (2, 0, 0) (B) (0, 5, 0) (C) (0, 0, 7) (D) (0, 5, 7)

Solution (A) is the correct answer.

Example 15 P is a point on the line segment joining the points (3, 2, -1) and (6, 2, -2). If x co-ordinate of P is 5, then its y co-ordinate is

- (A) 2 (B) 1 (C) -1 (D) -2

Solution (A) is the correct answer. Let P divides the line segment in the ratio of $\lambda : 1$,

x -coordinate of the point P may be expressed as $x = \frac{6\lambda + 3}{\lambda + 1}$ giving $\frac{6\lambda + 3}{\lambda + 1} = 5$ so that

$$\lambda = 2. \text{ Thus } y\text{-coordinate of P is } \frac{2\lambda + 2}{\lambda + 1} = 2.$$

Example 16 If α, β, γ are the angles that a line makes with the positive direction of x, y, z axis, respectively, then the direction cosines of the line are.

- (A) $\sin \alpha, \sin \beta, \sin \gamma$ (B) $\cos \alpha, \cos \beta, \cos \gamma$
 (C) $\tan \alpha, \tan \beta, \tan \gamma$ (D) $\cos^2 \alpha, \cos^2 \beta, \cos^2 \gamma$

Solution (B) is the correct answer.

Example 17 The distance of a point P (a, b, c) from x -axis is

(A) $\sqrt{a^2 + c^2}$ (B) $\sqrt{a^2 + b^2}$

(C) $\sqrt{b^2 + c^2}$ (D) $b^2 + c^2$

Solution (C) is the correct answer. The required distance is the distance of P (a, b, c) from Q ($a, 0, 0$), which is $\sqrt{b^2 + c^2}$.

Example 18 The equations of x -axis in space are

(A) $x = 0, y = 0$ (B) $x = 0, z = 0$ (C) $x = 0$ (D) $y = 0, z = 0$

Solution (D) is the correct answer. On x -axis the y - co-ordinate and z - co-ordinates are zero.

Example 19 A line makes equal angles with co-ordinate axis. Direction cosines of this line are

(A) $\pm (1, 1, 1)$ (B) $\pm \left(\frac{1}{\sqrt{3}}, \frac{1}{\sqrt{3}}, \frac{1}{\sqrt{3}} \right)$

(C) $\pm \left(\frac{1}{3}, \frac{1}{3}, \frac{1}{3} \right)$ (D) $\pm \left(\frac{1}{\sqrt{3}}, \frac{-1}{\sqrt{3}}, \frac{-1}{\sqrt{3}} \right)$

Solution (B) is the correct answer. Let the line makes angle α with each of the axis. Then, its direction cosines are $\cos \alpha, \cos \alpha, \cos \alpha$.

Since $\cos^2 \alpha + \cos^2 \alpha + \cos^2 \alpha = 1$. Therefore, $\cos \alpha = \frac{1}{\sqrt{3}}$

Fill in the blanks in each of the Examples from 20 to 22.

Example 20 If a line makes angles $\frac{3}{2}$, $\frac{3}{4}$ and $\frac{3}{4}$ with x, y, z axis, respectively, then its direction cosines are _____

Solution The direction cosines are $\cos \frac{3}{2}$, $\cos \frac{3}{4}$, $\cos \frac{3}{4}$, i.e., $\pm \left(0, -\frac{1}{\sqrt{2}}, \frac{1}{\sqrt{2}} \right)$.

Example 21 If a line makes angles α, β, γ with the positive directions of the coordinate axes, then the value of $\sin^2 \alpha + \sin^2 \beta + \sin^2 \gamma$ is _____

Solution Note that

$$\begin{aligned} \sin^2 \alpha + \sin^2 \beta + \sin^2 \gamma &= (1 - \cos^2 \alpha) + (1 - \cos^2 \beta) + (1 - \cos^2 \gamma) \\ &= 3 - (\cos^2 \alpha + \cos^2 \beta + \cos^2 \gamma) = 2. \end{aligned}$$

Example 22 If a line makes an angle of $\frac{\pi}{4}$ with each of y and z axis, then the angle which it makes with x -axis is _____

Solution Let it makes angle α with x -axis. Then $\cos^2 \alpha + \cos^2 \frac{\pi}{4} + \cos^2 \frac{\pi}{4} = 1$

which after simplification gives $\alpha = \frac{\pi}{2}$.

State whether the following statements are **True** or **False** in Examples 23 and 24.

Example 23 The points $(1, 2, 3)$, $(-2, 3, 4)$ and $(7, 0, 1)$ are collinear.

Solution Let A, B, C be the points $(1, 2, 3)$, $(-2, 3, 4)$ and $(7, 0, 1)$, respectively.

Then, the direction ratios of each of the lines AB and BC are proportional to $-3, 1, 1$.

Therefore, the statement is true.

Example 24 The vector equation of the line passing through the points $(3,5,4)$ and $(5,8,11)$ is

$$\vec{r} = 3\hat{i} + 5\hat{j} + 4\hat{k} + \lambda(2\hat{i} + 3\hat{j} + 7\hat{k})$$

Solution The position vector of the points $(3,5,4)$ and $(5,8,11)$ are

$$\vec{a} = 3\hat{i} + 5\hat{j} + 4\hat{k}, \vec{b} = 5\hat{i} + 8\hat{j} + 11\hat{k},$$

and therefore, the required equation of the line is given by

$$\vec{r} = 3\hat{i} + 5\hat{j} + 4\hat{k} + \lambda(2\hat{i} + 3\hat{j} + 7\hat{k})$$

Hence, the statement is true.

11.3 EXERCISE**Short Answer (S.A.)**

- Find the position vector of a point A in space such that \overline{OA} is inclined at 60° to OX and at 45° to OY and $|\overline{OA}| = 10$ units.
- Find the vector equation of the line which is parallel to the vector $3\hat{i} - 2\hat{j} + 6\hat{k}$ and which passes through the point $(1, -2, 3)$.
- Show that the lines

$$\frac{x-1}{2} = \frac{y-2}{3} = \frac{z-3}{4}$$

$$\text{and } \frac{x-4}{5} = \frac{y-1}{2} = z \text{ intersect.}$$

Also, find their point of intersection.

- Find the angle between the lines $\vec{r} = 3\hat{i} - 2\hat{j} + 6\hat{k} + \lambda(2\hat{i} + \hat{j} + 2\hat{k})$ and $\vec{r} = (2\hat{j} - 5\hat{k}) + \mu(6\hat{i} + 3\hat{j} + 2\hat{k})$
- Prove that the line through A $(0, -1, -1)$ and B $(4, 5, 1)$ intersects the line through C $(3, 9, 4)$ and D $(-4, 4, 4)$.
- Prove that the lines $x = py + q, z = ry + s$ and $x = p'y + q', z = r'y + s'$ are perpendicular if $pp' + rr' + 1 = 0$.
- Find the equation of a plane which bisects perpendicularly the line joining the points A $(2, 3, 4)$ and B $(4, 5, 8)$ at right angles.
- Find the equation of a plane which is at a distance $3\sqrt{3}$ units from origin and the normal to which is equally inclined to coordinate axis.
- If the line drawn from the point $(-2, -1, -3)$ meets a plane at right angle at the point $(1, -3, 3)$, find the equation of the plane.
- Find the equation of the plane through the points $(2, 1, 0)$, $(3, -2, -2)$ and $(3, 1, 7)$.

11. Find the equations of the two lines through the origin which intersect the line

$$\frac{x-3}{2} = \frac{y-3}{1} = \frac{z}{1} \text{ at angles of } \frac{\pi}{3} \text{ each.}$$

12. Find the angle between the lines whose direction cosines are given by the equations $l + m + n = 0$, $l^2 + m^2 - n^2 = 0$.

13. If a variable line in two adjacent positions has direction cosines l, m, n and $l + \delta l, m + \delta m, n + \delta n$, show that the small angle $\delta\theta$ between the two positions is given by

$$\delta\theta^2 = \delta l^2 + \delta m^2 + \delta n^2$$

14. O is the origin and A is (a, b, c) . Find the direction cosines of the line OA and the equation of plane through A at right angle to OA.

15. Two systems of rectangular axis have the same origin. If a plane cuts them at distances a, b, c and a', b', c' , respectively, from the origin, prove that

$$\frac{1}{a^2} + \frac{1}{b^2} + \frac{1}{c^2} = \frac{1}{a'^2} + \frac{1}{b'^2} + \frac{1}{c'^2}.$$

Long Answer (L.A.)

16. Find the foot of perpendicular from the point $(2, 3, -8)$ to the line

$$\frac{4-x}{2} = \frac{y}{6} = \frac{1-z}{3}. \text{ Also, find the perpendicular distance from the given point to the line.}$$

17. Find the distance of a point $(2, 4, -1)$ from the line

$$\frac{x-5}{1} = \frac{y-3}{4} = \frac{z-6}{-9}$$

18. Find the length and the foot of perpendicular from the point $\left(1, \frac{3}{2}, 2\right)$ to the plane $2x - 2y + 4z + 5 = 0$.

19. Find the equations of the line passing through the point $(3, 0, 1)$ and parallel to the planes $x + 2y = 0$ and $3y - z = 0$.

20. Find the equation of the plane through the points $(2,1,-1)$ and $(-1,3,4)$, and perpendicular to the plane $x - 2y + 4z = 10$.
21. Find the shortest distance between the lines given by $\vec{r} = (8 + 3\lambda)\hat{i} - (9 + 16\lambda)\hat{j} + (10 + 7\lambda)\hat{k}$ and $\vec{r} = 15\hat{i} + 29\hat{j} + 5\hat{k} + \mu(3\hat{i} + 8\hat{j} - 5\hat{k})$.
22. Find the equation of the plane which is perpendicular to the plane $5x + 3y + 6z + 8 = 0$ and which contains the line of intersection of the planes $x + 2y + 3z - 4 = 0$ and $2x + y - z + 5 = 0$.
23. The plane $ax + by = 0$ is rotated about its line of intersection with the plane $z = 0$ through an angle α . Prove that the equation of the plane in its new position is $ax + by \pm (\sqrt{a^2 + b^2} \tan \alpha)z = 0$.
24. Find the equation of the plane through the intersection of the planes $\vec{r} \cdot (\hat{i} + 3\hat{j}) - 6 = 0$ and $\vec{r} \cdot (3\hat{i} - \hat{j} - 4\hat{k}) = 0$, whose perpendicular distance from origin is unity.
25. Show that the points $(\hat{i} - \hat{j} + 3\hat{k})$ and $3(\hat{i} + \hat{j} + \hat{k})$ are equidistant from the plane $\vec{r} \cdot (5\hat{i} + 2\hat{j} - 7\hat{k}) + 9 = 0$ and lies on opposite side of it.
26. $\overline{AB} = 3\hat{i} - \hat{j} + \hat{k}$ and $\overline{CD} = -3\hat{i} + 2\hat{j} + 4\hat{k}$ are two vectors. The position vectors of the points A and C are $6\hat{i} + 7\hat{j} + 4\hat{k}$ and $-9\hat{j} + 2\hat{k}$, respectively. Find the position vector of a point P on the line AB and a point Q on the line CD such that \overline{PQ} is perpendicular to \overline{AB} and \overline{CD} both.
27. Show that the straight lines whose direction cosines are given by $2l + 2m - n = 0$ and $mn + nl + lm = 0$ are at right angles.
28. If $l_1, m_1, n_1; l_2, m_2, n_2; l_3, m_3, n_3$ are the direction cosines of three mutually perpendicular lines, prove that the line whose direction cosines are proportional to $l_1 + l_2 + l_3, m_1 + m_2 + m_3, n_1 + n_2 + n_3$ makes equal angles with them.

Objective Type Questions

Choose the correct answer from the given four options in each of the Exercises from 29 to 36.

29. Distance of the point (α, β, γ) from y-axis is

- (A) β (B) $|\beta|$ (C) $|\beta|+|\gamma|$ (D) $\sqrt{\alpha^2 + \gamma^2}$
- 30.** If the directions cosines of a line are k, k, k , then
- (A) $k > 0$ (B) $0 < k < 1$ (C) $k = 1$ (D) $k = \frac{1}{\sqrt{3}}$ or $-\frac{1}{\sqrt{3}}$
- 31.** The distance of the plane $\vec{r} \cdot \left(\frac{2}{7}\hat{i} + \frac{3}{7}\hat{j} - \frac{6}{7}\hat{k} \right) = 1$ from the origin is
- (A) 1 (B) 7 (C) $\frac{1}{7}$ (D) None of these
- 32.** The sine of the angle between the straight line $\frac{x}{3} = \frac{y}{4} = \frac{z}{5}$ and the plane $2x - 2y + z = 5$ is
- (A) $\frac{10}{6\sqrt{5}}$ (B) $\frac{4}{5\sqrt{2}}$ (C) $\frac{2\sqrt{3}}{5}$ (D) $\frac{\sqrt{2}}{10}$
- 33.** The reflection of the point (α, β, γ) in the xy -plane is
- (A) $(\alpha, \beta, 0)$ (B) $(0, 0, \gamma)$ (C) $(-\alpha, -\beta, \gamma)$ (D) $(\alpha, \beta, -\gamma)$
- 34.** The area of the quadrilateral ABCD, where A(0, 4, 1), B(2, 3, -1), C(4, 5, 0) and D(2, 6, 2), is equal to
- (A) 9 sq. units (B) 18 sq. units (C) 27 sq. units (D) 81 sq. units
- 35.** The locus represented by $xy + yz = 0$ is
- (A) A pair of perpendicular lines (B) A pair of parallel lines
(C) A pair of parallel planes (D) A pair of perpendicular planes
- 36.** The plane $2x - 3y + 6z - 11 = 0$ makes an angle $\sin^{-1}(\alpha)$ with x-axis. The value of α is equal to
- (A) $\frac{\sqrt{3}}{2}$ (B) $\frac{\sqrt{2}}{3}$ (C) $\frac{2}{7}$ (D) $\frac{3}{7}$

Fill in the blanks in each of the Exercises 37 to 41.

37. A plane passes through the points $(2,0,0)$, $(0,3,0)$ and $(0,0,4)$. The equation of plane is _____.
38. The direction cosines of the vector $(2\hat{i} - 2\hat{j} - \hat{k})$ are _____.
39. The vector equation of the line $\frac{x-5}{3} = \frac{y-4}{7} = \frac{z-6}{2}$ is _____.
40. The vector equation of the line through the points $(3,4,-7)$ and $(1,-1,6)$ is _____.
41. The cartesian equation of the plane $\vec{r} \cdot (\hat{i} - \hat{j} - \hat{k}) = 2$ is _____.

State **True** or **False** for the statements in each of the Exercises 42 to 49.

42. The unit vector normal to the plane $x + 2y + 3z - 6 = 0$ is $\frac{1}{\sqrt{14}}\hat{i} + \frac{2}{\sqrt{14}}\hat{j} + \frac{3}{\sqrt{14}}\hat{k}$.
43. The intercepts made by the plane $2x - 3y + 5z + 4 = 0$ on the co-ordinate axis are $-2, \frac{4}{3}, -\frac{4}{5}$.
44. The angle between the line $\vec{r} = (5\hat{i} - \hat{j} - 4\hat{k}) + \lambda(2\hat{i} - \hat{j} - \hat{k})$ and the plane $\vec{r} \cdot (3\hat{i} - 4\hat{j} - \hat{k}) = 5$ is $\sin^{-1} \frac{5}{2\sqrt{91}}$.
45. The angle between the planes $\vec{r} \cdot (2\hat{i} - 3\hat{j} - \hat{k}) = 1$ and $\vec{r} \cdot (\hat{i} - \hat{j}) = 4$ is $\cos^{-1} \frac{-5}{\sqrt{58}}$.
46. The line $\vec{r} = 2\hat{i} - 3\hat{j} - \hat{k} + \lambda(\hat{i} - \hat{j} - 2\hat{k})$ lies in the plane $\vec{r} \cdot (3\hat{i} - \hat{j} - \hat{k}) = 2 = 0$.
47. The vector equation of the line $\frac{x-5}{3} = \frac{y-4}{7} = \frac{z-6}{2}$ is _____.

$$\vec{r} = 5\hat{i} - 4\hat{j} + 6\hat{k} \quad (3\hat{i} - 7\hat{j} + 2\hat{k}).$$

- 48.** The equation of a line, which is parallel to $2\hat{i} - \hat{j} + 3\hat{k}$ and which passes through the point $(5, -2, 4)$, is $\frac{x-5}{2} = \frac{y+2}{-1} = \frac{z-4}{3}$.
- 49.** If the foot of perpendicular drawn from the origin to a plane is $(5, -3, -2)$, then the equation of plane is $\vec{r} \cdot (5\hat{i} - 3\hat{j} - 2\hat{k}) = 38$.



LINEAR PROGRAMMING

12.1 Overview

12.1.1 An Optimisation Problem A problem which seeks to maximise or minimise a function is called an optimisation problem. An optimisation problem may involve maximisation of profit, production etc or minimisation of cost, from available resources etc.

12.1.2 A Linear Programming Problem (LPP)

A linear programming problem deals with the optimisation (maximisation/minimisation) of a **linear function** of two variables (say x and y) known as **objective function** subject to the conditions that the variables are non-negative and satisfy a set of linear inequalities (called **linear constraints**). A linear programming problem is a special type of optimisation problem.

12.1.3 Objective Function Linear function $Z = ax + by$, where a and b are constants, which has to be maximised or minimised is called a linear objective function.

12.1.4 Decision Variables In the objective function $Z = ax + by$, x and y are called decision variables.

12.1.5 Constraints The linear inequalities or restrictions on the variables of an LPP are called **constraints**. The conditions $x \geq 0$, $y \geq 0$ are called non-negative constraints.

12.1.6 Feasible Region The common region determined by all the constraints including non-negative constraints $x \geq 0$, $y \geq 0$ of an LPP is called the feasible region for the problem.

12.1.7 Feasible Solutions Points within and on the boundary of the feasible region for an LPP represent feasible solutions.

12.1.8 Infeasible Solutions Any Point outside feasible region is called an infeasible solution.

12.1.9 Optimal (feasible) Solution Any point in the feasible region that gives the optimal value (maximum or minimum) of the objective function is called an optimal solution.

Following theorems are fundamental in solving LPPs.

12.1.10 Theorem 1 Let R be the feasible region (convex polygon) for an LPP and let $Z = ax + by$ be the objective function. When Z has an optimal value (maximum or minimum), where x and y are subject to constraints described by linear inequalities, this optimal value must occur at a corner point (vertex) of the feasible region.

Theorem 2 Let R be the feasible region for a LPP and let $Z = ax + by$ be the objective function. If R is **bounded**, then the objective function Z has both a maximum and a minimum value on R and each of these occur at a corner point of R .

If the feasible region R is **unbounded**, then a maximum or a minimum value of the objective function may or may not exist. However, if it exists, it must occur at a corner point of R .

12.1.11 Corner point method for solving a LPP

The method comprises of the following steps :

- (1) Find the feasible region of the LPP and determine its corner points (vertices) either by inspection or by solving the two equations of the lines intersecting at that point.
- (2) Evaluate the objective function $Z = ax + by$ at each corner point.
Let M and m , respectively denote the largest and the smallest values of Z .
- (3) (i) When the feasible region is *bounded*, M and m are, respectively, the maximum and minimum values of Z .
(ii) In case, the feasible region is *unbounded*.
(a) M is the maximum value of Z , if the open half plane determined by $ax + by > M$ has no point in common with the feasible region. Otherwise, Z has no maximum value.
(b) Similarly, m is the minimum of Z , if the open half plane determined by $ax + by < m$ has no point in common with the feasible region. Otherwise, Z has no minimum value.

12.1.12 Multiple optimal points If two corner points of the feasible region are optimal solutions of the same type, i.e., both produce the same maximum or minimum, then any point on the line segment joining these two points is also an optimal solution of the same type.

12.2 Solved Examples

Short Answer (S.A.)

Example 1 Determine the maximum value of $Z = 4x + 3y$ if the feasible region for an LPP is shown in Fig. 12.1.

Solution The feasible region is bounded. Therefore, maximum of Z must occur at the corner point of the feasible region (Fig. 12.1).

Corner Point	Value of Z
O, (0, 0)	$4(0) + 3(0) = 0$
A (25, 0)	$4(25) + 3(0) = 100$
B (16, 16)	$4(16) + 3(16) = \mathbf{112}$ ← (Maximum)
C (0, 24)	$4(0) + 3(24) = 72$

Hence, the maximum value of Z is 112.

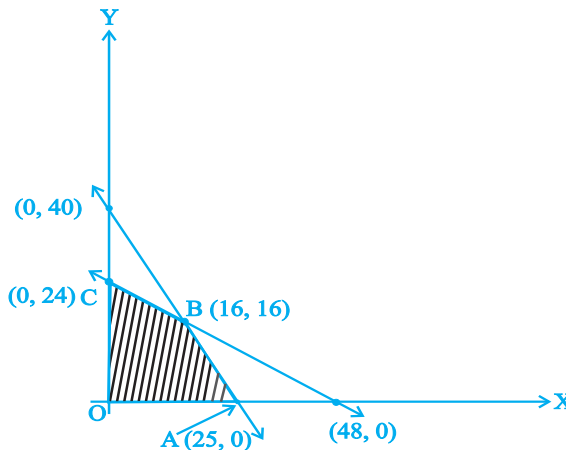

Fig.12.1 Fig. 12.1

Example 2 Determine the minimum value of $Z = 3x + 2y$ (if any), if the feasible region for an LPP is shown in Fig.12.2.

Solution The feasible region (R) is unbounded. Therefore minimum of Z may or may not exist. If it exists, it will be at the corner point (Fig.12.2).

Corner Point	Value of Z
A, (12, 0)	$3(12) + 2(0) = 36$
B (4, 2)	$3(4) + 2(2) = 16$
C (1, 5)	$3(1) + 2(5) = \mathbf{13}$ ← (smallest)
D (0, 10)	$3(0) + 2(10) = 20$

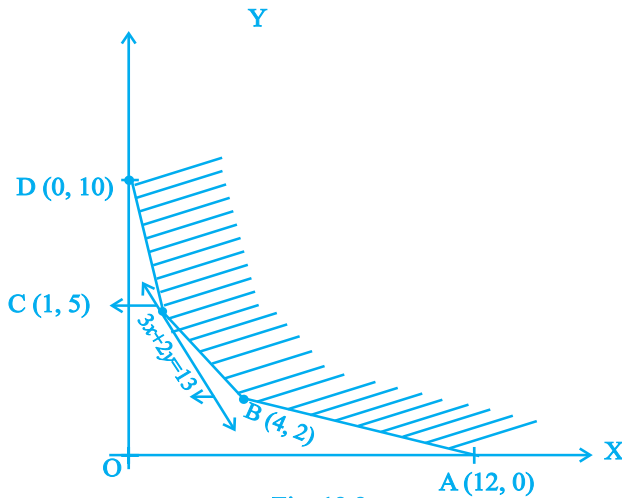

Fig. 12.2

Let us graph $3x + 2y < 13$. We see that the open half plane determined by $3x + 2y < 13$ and R do not have a common point. So, the smallest value 13 is the minimum value of Z.

Example 3 Solve the following LPP graphically:

Maximise $Z = 2x + 3y$,
 subject to $x + y \leq 4$, $x \geq 0$, $y \geq 0$

Solution The shaded region (OAB) in the Fig. 12.3 is the feasible region determined by the system of constraints $x \geq 0$, $y \geq 0$ and $x + y \leq 4$.

The feasible region OAB is **bounded**, so, maximum value will occur at a corner point of the feasible region.

Corner Points are O(0, 0), A (4, 0) and B (0, 4).

Evaluate Z at each of these corner point.

Corner Point	Value of Z
O, (0, 0)	$2(0) + 3(0) = 0$
A (4, 0)	$2(4) + 3(0) = 8$
B (0, 4)	$2(0) + 3(4) = \mathbf{12}$

← Maximum

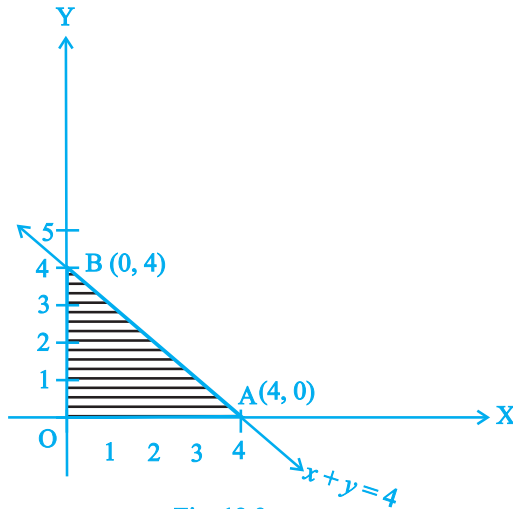

Fig. 12.3

Hence, the maximum value of Z is 12 at the point $(0, 4)$

Example 4 A manufacturing company makes two types of television sets; one is black and white and the other is colour. The company has resources to make at most 300 sets a week. It takes Rs 1800 to make a black and white set and Rs 2700 to make a coloured set. The company can spend not more than Rs 648000 a week to make television sets. If it makes a profit of Rs 510 per black and white set and Rs 675 per coloured set, how many sets of each type should be produced so that the company has maximum profit? Formulate this problem as a LPP given that the objective is to maximise the profit.

Solution Let x and y denote, respectively, the number of black and white sets and coloured sets made each week. Thus

$$x \geq 0, y \geq 0$$

Since the company can make at most 300 sets a week, therefore,

$$x + y \leq 300$$

Weekly cost (in Rs) of manufacturing the set is

$$1800x + 2700y$$

and the company can spend upto Rs. 648000. Therefore,

$$1800x + 2700y \leq 648000, \text{ i.e., or } 2x + 3y \leq 720$$

The total profit on x black and white sets and y colour sets is Rs $(510x + 675y)$. Let $Z = 510x + 675y$. This is the **objective function**.

Thus, the mathematical formulation of the problem is

$$\text{Maximise } Z = 510x + 675y$$

subject to the constraints :

$$\begin{aligned} x + y &= 300 \\ 2x + 3y &= 720 \\ x \geq 0, y &\geq 0 \end{aligned}$$

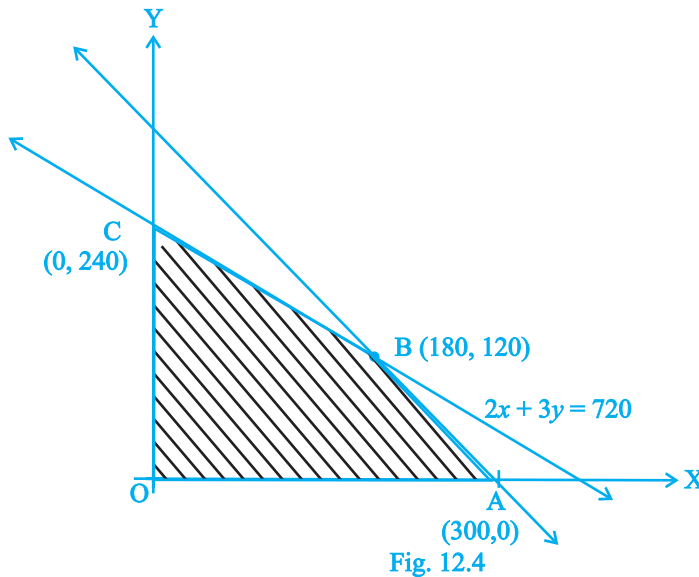

Fig. 12.4

Long Answer (L.A.)

Example 5 Refer to Example 4. Solve the LPP.

Solution The problem is :

$$\text{Maximise } Z = 510x + 675y$$

subject to the constraints :

$$\begin{aligned} x + y &= 300 \\ 2x + 3y &= 720 \\ x \geq 0, y &\geq 0 \end{aligned}$$

The feasible region OABC is shown in the Fig. 12.4.

Since the feasible region is bounded, therefore maximum of Z must occur at the corner point of OBC.

Corner Point	Value of Z
O (0, 0)	$510 (0) + 675 (0) = 0$
A (300, 0)	$510 (300) + 675 (0) = 153000$
B (180, 120)	$510 (180) + 675 (120) = \mathbf{172800}$
C (0, 240)	$510 (0) + 675 (240) = 162000$

← Maximum

Thus, maximum Z is 172800 at the point (180, 120), i.e., the company should produce 180 black and white television sets and 120 coloured television sets to get maximum profit.

Example 6 Minimise $Z = 3x + 5y$ subject to the constraints :

$$x + 2y \geq 10$$

$$x + y \geq 6$$

$$3x + y \geq 8$$

$$x, y \geq 0$$

Solution We first draw the graphs of $x + 2y = 10$, $x + y = 6$, $3x + y = 8$. The shaded region ABCD is the feasible region (R) determined by the above constraints. The feasible region is unbounded. Therefore, minimum of Z may or may not occur. If it occurs, it will be on the corner point.

Corner Point	Value of Z
A (0, 8)	40
B (1, 5)	28
C (2, 4)	26
D (10, 0)	30

← smallest

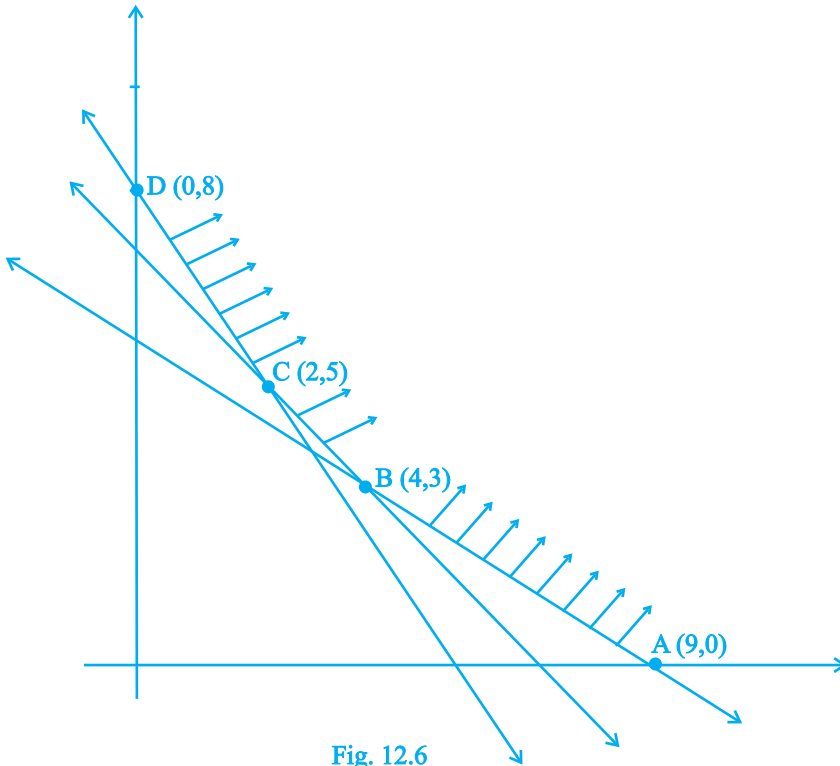

Fig. 12.6

Solution The correct answer is (B).

Fill in the blanks in each of the Examples 9 and 10:

Example 9 In a LPP, the linear function which has to be maximised or minimised is called a linear _____ function.

Solution Objective.

Example 10 The common region determined by all the linear constraints of a LPP is called the _____ region.

Solution Feasible.

State whether the statements in Examples 11 and 12 are **True** or **False**.

Example 11 If the feasible region for a linear programming problem is bounded, then the objective function $Z = ax + by$ has both a maximum and a minimum value on R.

Solution True

Example 12 The minimum value of the objective function $Z = ax + by$ in a linear programming problem always occurs at only one corner point of the feasible region.

Solution False

The minimum value can also occur at more than one corner points of the feasible region.

12.3 EXERCISE

Short Answer (S.A.)

1. Determine the maximum value of $Z = 11x + 7y$ subject to the constraints :
 $2x + y \leq 6, x \leq 2, x \geq 0, y \geq 0$.
2. Maximise $Z = 3x + 4y$, subject to the constraints: $x + y \leq 1, x \geq 0, y \geq 0$.
3. Maximise the function $Z = 11x + 7y$, subject to the constraints: $x \leq 3, y \leq 2, x \geq 0, y \geq 0$.
4. Minimise $Z = 13x - 15y$ subject to the constraints : $x + y \leq 7, 2x - 3y + 6 \geq 0, x \geq 0, y \geq 0$.
5. Determine the maximum value of $Z = 3x + 4y$ if the feasible region (shaded) for a LPP is shown in Fig.12.7.

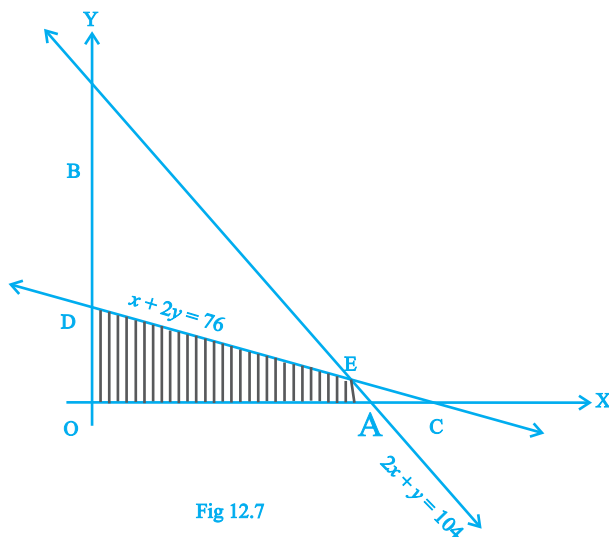

Fig 12.7

6. Feasible region (shaded) for a LPP is shown in Fig. 12.8.

Maximise $Z = 5x + 7y$.

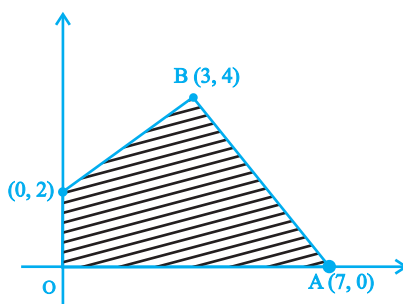
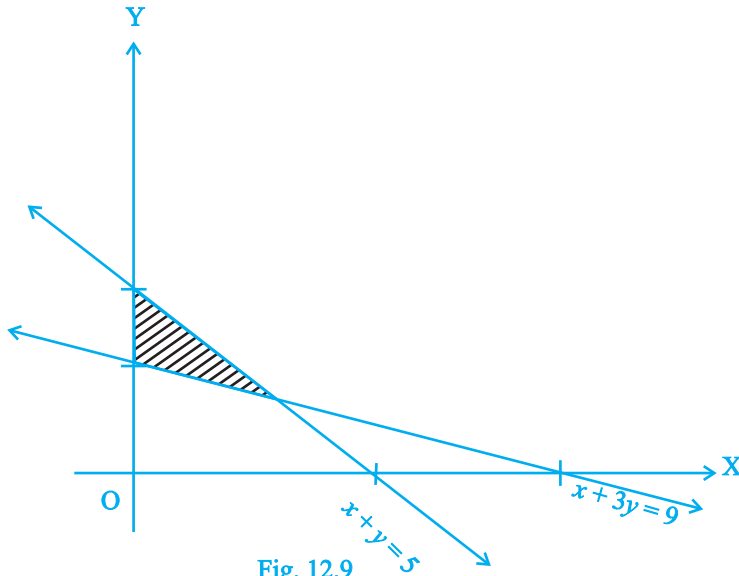
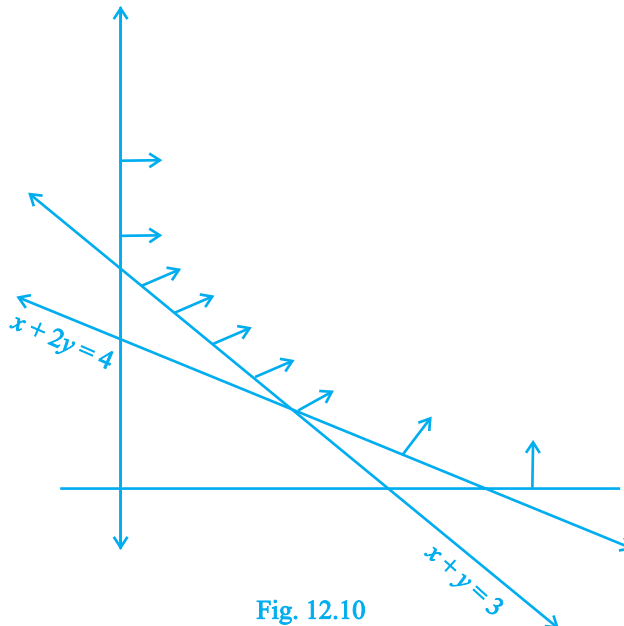

Fig. 12.8

7. The feasible region for a LPP is shown in Fig. 12.9. Find the minimum value of $Z = 11x + 7y$.



8. Refer to Exercise 7 above. Find the maximum value of Z .
9. The feasible region for a LPP is shown in Fig. 12.10. Evaluate $Z = 4x + y$ at each of the corner points of this region. Find the minimum value of Z , if it exists.



10. In Fig. 12.11, the feasible region (shaded) for a LPP is shown. Determine the maximum and minimum value of $Z = x + 2y$

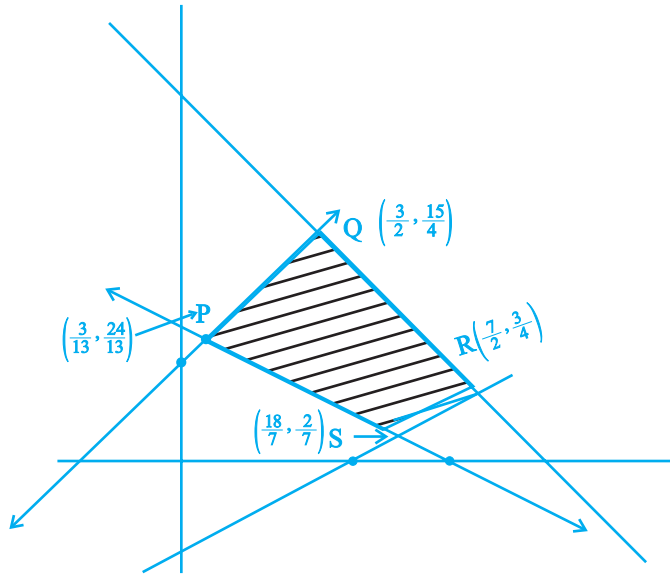

Fig. 12.11

11. A manufacturer of electronic circuits has a stock of 200 resistors, 120 transistors and 150 capacitors and is required to produce two types of circuits A and B. Type A requires 20 resistors, 10 transistors and 10 capacitors. Type B requires 10 resistors, 20 transistors and 30 capacitors. If the profit on type A circuit is Rs 50 and that on type B circuit is Rs 60, formulate this problem as a LPP so that the manufacturer can maximise his profit.
12. A firm has to transport 1200 packages using large vans which can carry 200 packages each and small vans which can take 80 packages each. The cost for engaging each large van is Rs 400 and each small van is Rs 200. Not more than Rs 3000 is to be spent on the job and the number of large vans can not exceed the number of small vans. Formulate this problem as a LPP given that the objective is to minimise cost.
13. A company manufactures two types of screws A and B. All the screws have to pass through a threading machine and a slotting machine. A box of Type A screws requires 2 minutes on the threading machine and 3 minutes on the slotting machine. A box of type B screws requires 8 minutes of threading on the threading machine and 2 minutes on the slotting machine. In a week, each machine is available for 60 hours.

On selling these screws, the company gets a profit of Rs 100 per box on type A screws and Rs 170 per box on type B screws.

Formulate this problem as a LPP given that the objective is to maximise profit.

- 14.** A company manufactures two types of sweaters : type A and type B. It costs Rs 360 to make a type A sweater and Rs 120 to make a type B sweater. The company can make at most 300 sweaters and spend at most Rs 72000 a day. The number of sweaters of type B cannot exceed the number of sweaters of type A by more than 100. The company makes a profit of Rs 200 for each sweater of type A and Rs 120 for every sweater of type B.

Formulate this problem as a LPP to maximise the profit to the company.

- 15.** A man rides his motorcycle at the speed of 50 km/hour. He has to spend Rs 2 per km on petrol. If he rides it at a faster speed of 80 km/hour, the petrol cost increases to Rs 3 per km. He has atmost Rs 120 to spend on petrol and one hour's time. He wishes to find the maximum distance that he can travel.

Express this problem as a linear programming problem.

Long Answer (L.A.)

- 16.** Refer to Exercise 11. How many of circuits of Type A and of Type B, should be produced by the manufacturer so as to maximise his profit? Determine the maximum profit.
- 17.** Refer to Exercise 12. What will be the minimum cost?
- 18.** Refer to Exercise 13. Solve the linear programming problem and determine the maximum profit to the manufacturer.
- 19.** Refer to Exercise 14. How many sweaters of each type should the company make in a day to get a maximum profit? What is the maximum profit.
- 20.** Refer to Exercise 15. Determine the maximum distance that the man can travel.
- 21.** Maximise $Z = x + y$ subject to $x + 4y \leq 8$, $2x + 3y \leq 12$, $3x + y \leq 9$, $x \geq 0$, $y \geq 0$.
- 22.** A manufacturer produces two Models of bikes - Model X and Model Y. Model X takes a 6 man-hours to make per unit, while Model Y takes 10 man-hours per unit. There is a total of 450 man-hour available per week. Handling and Marketing costs are Rs 2000 and Rs 1000 per unit for Models X and Y respectively. The total funds available for these purposes are Rs 80,000 per week. Profits per unit for Models X and Y are Rs 1000 and Rs 500, respectively. How many bikes of each model should the manufacturer produce so as to yield a maximum profit? Find the maximum profit.

23. In order to supplement daily diet, a person wishes to take some X and some Y tablets. The contents of iron, calcium and vitamins in X and Y (in milligrams per tablet) are given as below:

Tablets	Iron	Calcium	Vitamin
X	6	3	2
Y	2	3	4

The person needs at least 18 milligrams of iron, 21 milligrams of calcium and 16 milligram of vitamins. The price of each tablet of X and Y is Rs 2 and Re 1 respectively. How many tablets of each should the person take in order to satisfy the above requirement at the minimum cost?

24. A company makes 3 model of calculators: A, B and C at factory I and factory II. The company has orders for at least 6400 calculators of model A, 4000 calculator of model B and 4800 calculator of model C. At factory I, 50 calculators of model A, 50 of model B and 30 of model C are made every day; at factory II, 40 calculators of model A, 20 of model B and 40 of model C are made every day. It costs Rs 12000 and Rs 15000 each day to operate factory I and II, respectively. Find the number of days each factory should operate to minimise the operating costs and still meet the demand.

25. Maximise and Minimise $Z = 3x - 4y$
 subject to
- $$\begin{aligned} x - 2y &\leq 0 \\ -3x + y &\leq 4 \\ x - y &\leq 6 \\ x, y &\geq 0 \end{aligned}$$

Objective Type Questions

Choose the correct answer from the given four options in each of the Exercises 26 to 34.

26. The corner points of the feasible region determined by the system of linear constraints are $(0, 0)$, $(0, 40)$, $(20, 40)$, $(60, 20)$, $(60, 0)$. The objective function is $Z = 4x + 3y$.

Compare the quantity in Column A and Column B

Column A

Maximum of Z

Column B

325

- (A) The quantity in column A is greater
 (B) The quantity in column B is greater

- (C) The two quantities are equal
- (D) The relationship can not be determined on the basis of the information supplied

27. The feasible solution for a LPP is shown in Fig. 12.12. Let $Z = 3x - 4y$ be the

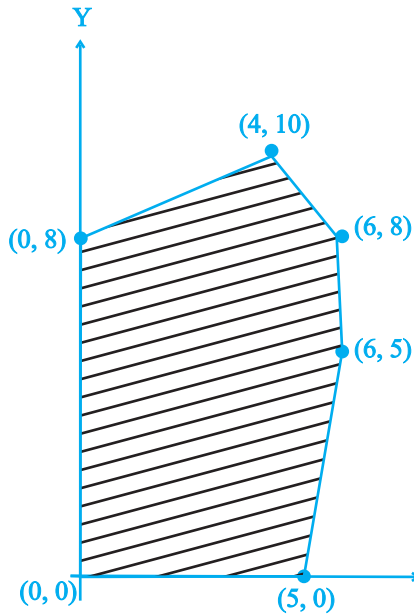

Fig. 12.12

objective function. Minimum of Z occurs at

- (A) (0, 0) (B) (0, 8) (C) (5, 0) (D) (4, 10)
28. Refer to Exercise 27. Maximum of Z occurs at
- (A) (5, 0) (B) (6, 5) (C) (6, 8) (D) (4, 10)
29. Refer to Exercise 27. (Maximum value of Z + Minimum value of Z) is equal to
- (A) 13 (B) 1 (C) -13 (D) -17
30. The feasible region for an LPP is shown in the Fig. 12.13. Let $F = 3x - 4y$ be the objective function. Maximum value of F is.

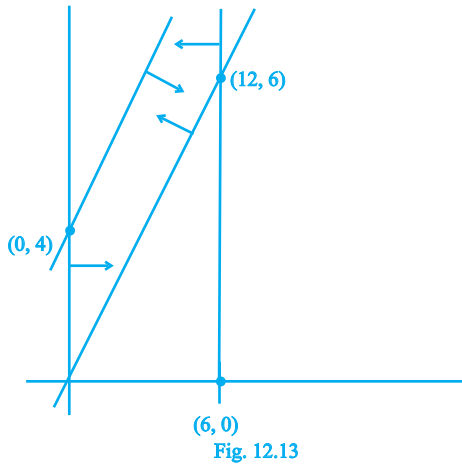

Fig. 12.13

- (A) 0 (B) 8 (C) 12 (D) - 18
- 31.** Refer to Exercise 30. Minimum value of F is
 (A) 0 (B) - 16 (C) 12 (D) does not exist
- 32.** Corner points of the feasible region for an LPP are (0, 2), (3, 0), (6, 0), (6, 8) and (0, 5).
 Let $F = 4x + 6y$ be the objective function.
 The Minimum value of F occurs at
 (A) (0, 2) only
 (B) (3, 0) only
 (C) the mid point of the line segment joining the points (0, 2) and (3, 0) only
 (D) any point on the line segment joining the points (0, 2) and (3, 0).
- 33.** Refer to Exercise 32, Maximum of F - Minimum of F =
 (A) 60 (B) 48 (C) 42 (D) 18
- 34.** Corner points of the feasible region determined by the system of linear constraints are (0, 3), (1, 1) and (3, 0). Let $Z = px + qy$, where $p, q > 0$. Condition on p and q so that the minimum of Z occurs at (3, 0) and (1, 1) is
 (A) $p = 2q$ (B) $p = \frac{q}{2}$ (C) $p = 3q$ (D) $p = q$

Fill in the blanks in each of the Exercises 35 to 41.

35. In a LPP, the linear inequalities or restrictions on the variables are called _____.
36. In a LPP, the objective function is always _____.
37. If the feasible region for a LPP is _____, then the optimal value of the objective function $Z = ax + by$ may or may not exist.
38. In a LPP if the objective function $Z = ax + by$ has the same maximum value on two corner points of the feasible region, then every point on the line segment joining these two points give the same _____ value.
39. A feasible region of a system of linear inequalities is said to be _____ if it can be enclosed within a circle.
40. A corner point of a feasible region is a point in the region which is the _____ of two boundary lines.
41. The feasible region for an LPP is always a _____ polygon.

State whether the statements in Exercises 42 to 45 are True or False.

42. If the feasible region for a LPP is unbounded, maximum or minimum of the objective function $Z = ax + by$ may or may not exist.
43. Maximum value of the objective function $Z = ax + by$ in a LPP always occurs at only one corner point of the feasible region.
44. In a LPP, the minimum value of the objective function $Z = ax + by$ is always 0 if origin is one of the corner point of the feasible region.
45. In a LPP, the maximum value of the objective function $Z = ax + by$ is always finite.



PROBABILITY

13.1 Overview

13.1.1 Conditional Probability

If E and F are two events associated with the same sample space of a random experiment, then the conditional probability of the event E under the condition that the event F has occurred, written as $P(E | F)$, is given by

$$P(E | F) = \frac{P(E \cap F)}{P(F)}, \quad P(F) \neq 0$$

13.1.2 Properties of Conditional Probability

Let E and F be events associated with the sample space S of an experiment. Then:

- (i) $P(S | F) = P(F | F) = 1$
- (ii) $P[(A \cup B) | F] = P(A | F) + P(B | F) - P[(A \cap B) | F]$,
where A and B are any two events associated with S .
- (iii) $P(E' | F) = 1 - P(E | F)$

13.1.3 Multiplication Theorem on Probability

Let E and F be two events associated with a sample space of an experiment. Then

$$\begin{aligned} P(E \cap F) &= P(E) P(F | E), \quad P(E) \neq 0 \\ &= P(F) P(E | F), \quad P(F) \neq 0 \end{aligned}$$

If E , F and G are three events associated with a sample space, then

$$P(E \cap F \cap G) = P(E) P(F | E) P(G | E \cap F)$$

13.1.4 Independent Events

Let E and F be two events associated with a sample space S . If the probability of occurrence of one of them is not affected by the occurrence of the other, then we say that the two events are independent. Thus, two events E and F will be independent, if

$$(a) \quad P(F | E) = P(F), \text{ provided } P(E) \neq 0$$

$$(b) \quad P(E | F) = P(E), \text{ provided } P(F) \neq 0$$

Using the multiplication theorem on probability, we have

$$(c) \quad P(E \cap F) = P(E) P(F)$$

Three events A , B and C are said to be mutually independent if all the following conditions hold:

$$P(A \cap B) = P(A) P(B)$$

$$P(A \cap C) = P(A) P(C)$$

$$P(B \cap C) = P(B) P(C)$$

and
$$P(A \cap B \cap C) = P(A) P(B) P(C)$$

13.1.5 Partition of a Sample Space

A set of events E_1, E_2, \dots, E_n is said to represent a partition of a sample space S if

$$(a) \quad E_i \cap E_j = \phi, \quad i \neq j; \quad i, j = 1, 2, 3, \dots, n$$

$$(b) \quad E_i \cup E_2 \cup \dots \cup E_n = S, \text{ and}$$

$$(c) \quad \text{Each } E_i \neq \phi, \text{ i. e. } P(E_i) > 0 \text{ for all } i = 1, 2, \dots, n$$

13.1.6 Theorem of Total Probability

Let $\{E_1, E_2, \dots, E_n\}$ be a partition of the sample space S . Let A be any event associated with S , then

$$P(A) = \sum_{j=1}^n P(E_j) P(A | E_j)$$

13.1.7 Bayes' Theorem

If E_1, E_2, \dots, E_n are mutually exclusive and exhaustive events associated with a sample space, and A is any event of non zero probability, then

$$P(E_i | A) = \frac{P(E_i)P(A | E_i)}{\sum_{i=1}^n P(E_i)P(A | E_i)}$$

13.1.8 Random Variable and its Probability Distribution

A random variable is a real valued function whose domain is the sample space of a random experiment.

The probability distribution of a random variable X is the system of numbers

X :	x_1		x_2	...	x_n
P(X) :	p_1		p_2	...	p_n

where $p_i > 0, i = 1, 2, \dots, n, \sum_{i=1}^n p_i = 1$.

13.1.9 Mean and Variance of a Random Variable

Let X be a random variable assuming values x_1, x_2, \dots, x_n with probabilities p_1, p_2, \dots, p_n , respectively such that $p_i \geq 0, \sum_{i=1}^n p_i = 1$. Mean of X, denoted by μ [or expected value of X denoted by E (X)] is defined as

$$\mu = E (X) = \sum_{i=1}^n x_i p_i$$

and variance, denoted by σ^2 , is defined as

$$\sigma^2 = \sum_{i=1}^n (x_i - \mu)^2 p_i = \sum_{i=1}^n x_i^2 p_i - \mu^2$$

or equivalently

$$\sigma^2 = E (X - \mu)^2$$

Standard deviation of the random variable X is defined as

$$= \sqrt{\text{variance (X)}} = \sqrt{\sum_{i=1}^n (x_i - \mu)^2 p_i}$$

13.1.10 Bernoulli Trials

Trials of a random experiment are called Bernoulli trials, if they satisfy the following conditions:

- (i) There should be a finite number of trials
- (ii) The trials should be independent
- (iii) Each trial has exactly two outcomes: success or failure
- (iv) The probability of success (or failure) remains the same in each trial.

13.1.11 Binomial Distribution

A random variable X taking values 0, 1, 2, ..., n is said to have a binomial distribution with parameters n and p, if its probability distribution is given by

$$P (X = r) = {}^n C_r p^r q^{n-r},$$

where $q = 1 - p$ and $r = 0, 1, 2, \dots, n$.

13.2 Solved Examples

Short Answer (S. A.)

Example 1 A and B are two candidates seeking admission in a college. The probability that A is selected is 0.7 and the probability that exactly one of them is selected is 0.6. Find the probability that B is selected.

Solution Let p be the probability that B gets selected.

$$P (\text{Exactly one of A, B is selected}) = 0.6 \text{ (given)}$$

$$P (A \text{ is selected, B is not selected; B is selected, A is not selected}) = 0.6$$

$$P (A \cap B') + P (A' \cap B) = 0.6$$

$$P(A)P(B') + P(A')P(B) = 0.6$$

$$(0.7)(1-p) + (0.3)p = 0.6$$

$$p = 0.25$$

Thus the probability that B gets selected is 0.25.

Example 2 The probability of simultaneous occurrence of at least one of two events A and B is p . If the probability that exactly one of A, B occurs is q , then prove that $P(A') + P(B') = 2 - 2p + q$.

Solution Since $P(\text{exactly one of A, B occurs}) = q$ (given), we get

$$P(A \cup B) - P(A \cap B) = q$$

$$\Rightarrow p - P(A \cap B) = q$$

$$\Rightarrow P(A \cap B) = p - q$$

$$\Rightarrow 1 - P(A' \cup B') = p - q$$

$$\Rightarrow P(A' \cup B') = 1 - p + q$$

$$\Rightarrow P(A') + P(B') - P(A' \cap B') = 1 - p + q$$

$$\Rightarrow P(A') + P(B') = (1 - p + q) + P(A' \cap B')$$

$$= (1 - p + q) + (1 - P(A \cup B))$$

$$= (1 - p + q) + (1 - p)$$

$$= 2 - 2p + q.$$

Example 3 10% of the bulbs produced in a factory are of red colour and 2% are red and defective. If one bulb is picked up at random, determine the probability of its being defective if it is red.

Solution Let A and B be the events that the bulb is red and defective, respectively.

$$P(A) = \frac{10}{100} = \frac{1}{10},$$

$$P(A \cap B) = \frac{2}{100} = \frac{1}{50}$$

$$P(B | A) = \frac{P(A \cap B)}{P(A)} = \frac{1}{50} \times \frac{10}{1} = \frac{1}{5}$$

Thus the probability of the picked up bulb of its being defective, if it is red, is $\frac{1}{5}$.

Example 4 Two dice are thrown together. Let A be the event ‘getting 6 on the first die’ and B be the event ‘getting 2 on the second die’. Are the events A and B independent?

Solution: $A = \{(6, 1), (6, 2), (6, 3), (6, 4), (6, 5), (6, 6)\}$

$B = \{(1, 2), (2, 2), (3, 2), (4, 2), (5, 2), (6, 2)\}$

$A \cap B = \{(6, 2)\}$

$$P(A) = \frac{6}{36} = \frac{1}{6}, \quad P(B) = \frac{1}{6}, \quad P(A \cap B) = \frac{1}{36}$$

Events A and B will be independent if

$$P(A \cap B) = P(A) P(B)$$

$$\text{i.e., LHS} = P(A \cap B) = \frac{1}{36}, \text{ RHS} = P(A) P(B) = \frac{1}{6} \times \frac{1}{6} = \frac{1}{36}$$

Hence, A and B are independent.

Example 5 A committee of 4 students is selected at random from a group consisting 8 boys and 4 girls. Given that there is at least one girl on the committee, calculate the probability that there are exactly 2 girls on the committee.

Solution Let A denote the event that at least one girl will be chosen, and B the event that exactly 2 girls will be chosen. We require $P(B | A)$.

Since A denotes the event that at least one girl will be chosen, A' denotes that no girl is chosen, i.e., 4 boys are chosen. Then

$$P(A') = \frac{{}^8C_4}{{}^{12}C_4} = \frac{70}{495} = \frac{14}{99}$$

$$P(A) = 1 - \frac{14}{99} = \frac{85}{99}$$

$$\begin{aligned} \text{Now } P(A \cap B) &= P(2 \text{ boys and } 2 \text{ girls}) = \frac{{}^8C_2 \cdot {}^4C_2}{{}^{12}C_4} \\ &= \frac{6 \times 28}{495} = \frac{56}{165} \end{aligned}$$

$$\text{Thus } P(B | A) = \frac{P(A \cap B)}{P(A)} = \frac{56}{165} \times \frac{99}{85} = \frac{168}{425}$$

Example 6 Three machines E_1, E_2, E_3 in a certain factory produce 50%, 25% and 25%, respectively, of the total daily output of electric tubes. It is known that 4% of the tubes produced on each of machines E_1 and E_2 are defective, and that 5% of those produced on E_3 are defective. If one tube is picked up at random from a day's production, calculate the probability that it is defective.

Solution: Let D be the event that the picked up tube is defective

Let A_1, A_2 and A_3 be the events that the tube is produced on machines E_1, E_2 and E_3 , respectively.

$$P(D) = P(A_1)P(D | A_1) + P(A_2)P(D | A_2) + P(A_3)P(D | A_3) \quad (1)$$

$$P(A_1) = \frac{50}{100} = \frac{1}{2}, P(A_2) = \frac{1}{4}, P(A_3) = \frac{1}{4}$$

$$\text{Also } P(D | A_1) = P(D | A_2) = \frac{4}{100} = \frac{1}{25}$$

$$P(D | A_3) = \frac{5}{100} = \frac{1}{20}$$

Putting these values in (1), we get

$$\begin{aligned} P(D) &= \frac{1}{2} \times \frac{1}{25} + \frac{1}{4} \times \frac{1}{25} + \frac{1}{4} \times \frac{1}{20} \\ &= \frac{1}{50} + \frac{1}{100} + \frac{1}{80} = \frac{17}{400} = .0425 \end{aligned}$$

Example 7 Find the probability that in 10 throws of a fair die a score which is a multiple of 3 will be obtained in at least 8 of the throws.

Solution Here success is a score which is a multiple of 3 i.e., 3 or 6.

$$\text{Therefore, } p(3 \text{ or } 6) = \frac{2}{6} = \frac{1}{3}$$

The probability of r successes in 10 throws is given by

$$P(r) = {}^{10}C_r \left(\frac{1}{3}\right)^r \left(\frac{2}{3}\right)^{10-r}$$

$$\text{Now } P(\text{at least 8 successes}) = P(8) + P(9) + P(10)$$

$$\begin{aligned} &= {}^{10}C_8 \left(\frac{1}{3}\right)^8 \left(\frac{2}{3}\right)^2 + {}^{10}C_9 \left(\frac{1}{3}\right)^9 \left(\frac{2}{3}\right)^1 + {}^{10}C_{10} \left(\frac{1}{3}\right)^{10} \\ &= \frac{1}{3^{10}} [45 \times 4 + 10 \times 2 + 1] = \frac{201}{3^{10}} \end{aligned}$$

Example 8 A discrete random variable X has the following probability distribution:

X	1	2	3	4	5	6	7
P(X)	C	2C	2C	3C	C ²	2C ²	7C ² + C

Find the value of C . Also find the mean of the distribution.

Solution Since $\sum p_i = 1$, we have

$$C + 2C + 2C + 3C + C^2 + 2C^2 + 7C^2 + C = 1$$

$$\text{i.e., } 10C^2 + 9C - 1 = 0$$

$$\text{i.e. } (10C - 1)(C + 1) = 0$$

$$\Rightarrow C = \frac{1}{10}, \quad C = -1$$

Therefore, the permissible value of $C = \frac{1}{10}$ (Why?)

$$\begin{aligned}
 \text{Mean} &= \sum_{i=1}^n x_i p_i = \sum_{i=1}^7 x_i p_i \\
 &= 1 \times \frac{1}{10} + 2 \times \frac{2}{10} + 3 \times \frac{2}{10} + 4 \times \frac{3}{10} + 5 \left(\frac{1}{10} \right)^2 + 6 \times 2 \left(\frac{1}{10} \right)^2 + 7 \left(7 \left(\frac{1}{10} \right)^2 + \frac{1}{10} \right) \\
 &= \frac{1}{10} + \frac{4}{10} + \frac{6}{10} + \frac{12}{10} + \frac{5}{100} + \frac{12}{100} + \frac{49}{100} + \frac{7}{10} \\
 &= 3.66.
 \end{aligned}$$

Long Answer (L.A.)

Example 9 Four balls are to be drawn without replacement from a box containing 8 red and 4 white balls. If X denotes the number of red ball drawn, find the probability distribution of X .

Solution Since 4 balls have to be drawn, therefore, X can take the values 0, 1, 2, 3, 4.

$$P(X = 0) = P(\text{no red ball}) = P(4 \text{ white balls})$$

$$\frac{{}^4C_4}{{}^{12}C_4} = \frac{1}{495}$$

$$P(X = 1) = P(1 \text{ red ball and } 3 \text{ white balls})$$

$$\frac{{}^8C_1 \cdot {}^4C_3}{{}^{12}C_4} = \frac{32}{495}$$

$$P(X = 2) = P(2 \text{ red balls and } 2 \text{ white balls})$$

$$\frac{{}^8C_2 \cdot {}^4C_2}{{}^{12}C_4} = \frac{168}{495}$$

$$P(X = 3) = P(3 \text{ red balls and } 1 \text{ white ball})$$

$$\frac{{}^8C_3 \cdot {}^4C_1}{{}^{12}C_4} = \frac{224}{495}$$

$$P(X = 4) = P(4 \text{ red balls}) = \frac{{}^8C_4}{{}^{12}C_4} = \frac{70}{495}$$

Thus the following is the required probability distribution of X

X	0	1	2	3	4
P(X)	$\frac{1}{495}$	$\frac{32}{495}$	$\frac{168}{495}$	$\frac{224}{495}$	$\frac{70}{495}$

Example 10 Determine variance and standard deviation of the number of heads in three tosses of a coin.

Solution Let X denote the number of heads tossed. So, X can take the values 0, 1, 2, 3. When a coin is tossed three times, we get

Sample space S = {HHH, HHT, HTH, HTT, THH, THT, TTH, TTT}

$$P(X = 0) = P(\text{no head}) = P(\text{TTT}) = \frac{1}{8}$$

$$P(X = 1) = P(\text{one head}) = P(\text{HTT, THT, TTH}) = \frac{3}{8}$$

$$P(X = 2) = P(\text{two heads}) = P(\text{HHT, HTH, THH}) = \frac{3}{8}$$

$$P(X = 3) = P(\text{three heads}) = P(\text{HHH}) = \frac{1}{8}$$

Thus the probability distribution of X is:

X	0	1	2	3
P(X)	$\frac{1}{8}$	$\frac{3}{8}$	$\frac{3}{8}$	$\frac{1}{8}$

Variance of X = $\sigma^2 = \sum x_i^2 p_i - \mu^2$, (1)
 where μ is the mean of X given by

$$\mu = \sum x_i p_i = 0 \cdot \frac{1}{8} + 1 \cdot \frac{3}{8} + 2 \cdot \frac{3}{8} + 3 \cdot \frac{1}{8}$$

$$= \frac{3}{2} \quad (2)$$

Now

$$\Sigma x_i^2 p_i = 0^2 \cdot \frac{1}{8} + 1^2 \cdot \frac{3}{8} + 2^2 \cdot \frac{3}{8} + 3^2 \cdot \frac{1}{8} = 3 \quad (3)$$

From (1), (2) and (3), we get

$$\sigma^2 = 3 - \frac{3}{2} = \frac{3}{2}$$

$$\text{Standard deviation} = \sqrt{\frac{3}{2}} = \frac{\sqrt{3}}{\sqrt{2}} = \frac{\sqrt{3}}{2}$$

Example 11 Refer to Example 6. Calculate the probability that the defective tube was produced on machine E_1 .

Solution Now, we have to find $P(A_1/D)$.

$$\begin{aligned} P(A_1/D) &= \frac{P(A_1 \cap D)}{P(D)} = \frac{P(A_1)P(D/A_1)}{P(D)} \\ &= \frac{\frac{1}{2} \times \frac{1}{25}}{\frac{17}{400}} = \frac{8}{17} \end{aligned}$$

Example 12 A car manufacturing factory has two plants, X and Y. Plant X manufactures 70% of cars and plant Y manufactures 30%. 80% of the cars at plant X and 90% of the cars at plant Y are rated of standard quality. A car is chosen at random and is found to be of standard quality. What is the probability that it has come from plant X?

Solution Let E be the event that the car is of standard quality. Let B_1 and B_2 be the events that the car is manufactured in plants X and Y, respectively. Now

$$P(B_1) = \frac{70}{100} = \frac{7}{10}, \quad P(B_2) = \frac{30}{100} = \frac{3}{10}$$

$P(E|B_1)$ = Probability that a standard quality car is manufactured in plant

$$\begin{aligned}
 &= \frac{80}{100} = \frac{8}{10} \\
 P(E | B_2) &= \frac{90}{100} = \frac{9}{10} \\
 P(B_1 | E) &= \text{Probability that a standard quality car has come from plant X} \\
 &= \frac{P(B_1) \times P(E | B_1)}{P(B_1) \cdot P(E | B_1) + P(B_2) \cdot P(E | B_2)} \\
 &= \frac{\frac{7}{10} \times \frac{8}{10}}{\frac{7}{10} \times \frac{8}{10} + \frac{3}{10} \times \frac{9}{10}} = \frac{56}{83}
 \end{aligned}$$

Hence the required probability is $\frac{56}{83}$.

Objective Type Questions

Choose the correct answer from the given four options in each of the Examples 13 to 17.

Example 13 Let A and B be two events. If $P(A) = 0.2$, $P(B) = 0.4$, $P(A \cup B) = 0.6$, then $P(A | B)$ is equal to

- (A) 0.8 (B) 0.5 (C) 0.3 (D) 0

Solution The correct answer is (D). From the given data $P(A) + P(B) = P(A \cup B)$.

This shows that $P(A \cap B) = 0$. Thus $P(A | B) = \frac{P(A \cap B)}{P(B)} = 0$.

Example 14 Let A and B be two events such that $P(A) = 0.6$, $P(B) = 0.2$, and $P(A | B) = 0.5$.

Then $P(A' | B')$ equals

- (A) $\frac{1}{10}$ (B) $\frac{3}{10}$ (C) $\frac{3}{8}$ (D) $\frac{6}{7}$

Solution The correct answer is (C). $P(A \cap B) = P(A | B) P(B)$
 $= 0.5 \times 0.2 = 0.1$

$$\begin{aligned}
 P(A' | B') &= \frac{P(A' \cap B')}{P(B')} = \frac{P[(A \cup B)']}{P(B')} = \frac{1 - P(A \cup B)}{1 - P(B)} \\
 &= \frac{1 - P(A) - P(B) + P(A \cap B)}{1 - 0.2} = \frac{3}{8}.
 \end{aligned}$$

Example 15 If A and B are independent events such that $0 < P(A) < 1$ and $0 < P(B) < 1$, then which of the following is not correct?

- (A) A and B are mutually exclusive (B) A and B' are independent
 (C) A' and B are independent (D) A' and B' are independent

Solution The correct answer is (A).

Example 16 Let X be a discrete random variable. The probability distribution of X is given below:

X	30	10	-10
P(X)	$\frac{1}{5}$	$\frac{3}{10}$	$\frac{1}{2}$

Then E(X) is equal to

- (A) 6 (B) 4 (C) 3 (D) -5

Solution The correct answer is (B).

$$E(X) = 30 \times \frac{1}{5} + 10 \times \frac{3}{10} - 10 \times \frac{1}{2} = 4.$$

Example 17 Let X be a discrete random variable assuming values x_1, x_2, \dots, x_n with probabilities p_1, p_2, \dots, p_n , respectively. Then variance of X is given by

- (A) $E(X^2)$ (B) $E(X^2) + E(X)$ (C) $E(X^2) - [E(X)]^2$
 (D) $\sqrt{E(X^2) - [E(X)]^2}$

Solution The correct answer is (C).

Fill in the blanks in Examples 18 and 19

Example 18 If A and B are independent events such that $P(A) = p$, $P(B) = 2p$ and

$$P(\text{Exactly one of } A, B) = \frac{5}{9}, \text{ then } p = \underline{\hspace{2cm}}$$

Solution $p = \frac{1}{3}, \frac{5}{12} \quad \left[(1-p)(2p) + p(1-2p) = 3p - 4p^2 = \frac{5}{9} \right]$

Example 19 If A and B' are independent events then $P(A' \cup B) = 1 - \underline{\hspace{2cm}}$

Solution $P(A' \cup B) = 1 - P(A \cap B') = 1 - P(A) P(B')$
(since A and B' are independent).

State whether each of the statement in Examples 20 to 22 is **True** or **False**

Example 20 Let A and B be two independent events. Then $P(A \cap B) = P(A) + P(B)$

Solution False, because $P(A \cap B) = P(A) \cdot P(B)$ when events A and B are independent.

Example 21 Three events A, B and C are said to be independent if $P(A \cap B \cap C) = P(A) P(B) P(C)$.

Solution False. Reason is that A, B, C will be independent if they are pairwise independent and $P(A \cap B \cap C) = P(A) P(B) P(C)$.

Example 22 One of the condition of Bernoulli trials is that the trials are independent of each other.

Solution: True.

13.3 EXERCISE

Short Answer (S.A.)

- For a loaded die, the probabilities of outcomes are given as under:
 $P(1) = P(2) = 0.2, P(3) = P(5) = P(6) = 0.1$ and $P(4) = 0.3$.
The die is thrown two times. Let A and B be the events, 'same number each time', and 'a total score is 10 or more', respectively. Determine whether or not A and B are independent.
- Refer to Exercise 1 above. If the die were fair, determine whether or not the events A and B are independent.
- The probability that at least one of the two events A and B occurs is 0.6. If A and B occur simultaneously with probability 0.3, evaluate $P(\overline{A}) + P(\overline{B})$.
- A bag contains 5 red marbles and 3 black marbles. Three marbles are drawn one by one without replacement. What is the probability that at least one of the three marbles drawn be black, if the first marble is red?

5. Two dice are thrown together and the total score is noted. The events E, F and G are 'a total of 4', 'a total of 9 or more', and 'a total divisible by 5', respectively. Calculate $P(E)$, $P(F)$ and $P(G)$ and decide which pairs of events, if any, are independent.
6. Explain why the experiment of tossing a coin three times is said to have binomial distribution.
7. A and B are two events such that $P(A) = \frac{1}{2}$, $P(B) = \frac{1}{3}$ and $P(A \cap B) = \frac{1}{4}$.
Find :
(i) $P(A|B)$ (ii) $P(B|A)$ (iii) $P(A'|B)$ (iv) $P(A'|B')$
8. Three events A, B and C have probabilities $\frac{2}{5}$, $\frac{1}{3}$ and $\frac{1}{2}$, respectively. Given that $P(A \cap C) = \frac{1}{5}$ and $P(B \cap C) = \frac{1}{4}$, find the values of $P(C|B)$ and $P(A' \cap C')$.
9. Let E_1 and E_2 be two independent events such that $p(E_1) = p_1$ and $P(E_2) = p_2$. Describe in words of the events whose probabilities are:
(i) $p_1 p_2$ (ii) $(1-p_1) p_2$ (iii) $1-(1-p_1)(1-p_2)$ (iv) $p_1 + p_2 - 2p_1 p_2$
10. A discrete random variable X has the probability distribution given as below:
- | | | | | |
|------|-----|-------|--------|-----|
| X | 0.5 | 1 | 1.5 | 2 |
| P(X) | k | k^2 | $2k^2$ | k |
- (i) Find the value of k
(ii) Determine the mean of the distribution.
11. Prove that
(i) $P(A) = P(A \cap B) + P(A \cap \bar{B})$
(ii) $P(A \cup B) = P(A \cap B) + P(A \cap \bar{B}) + P(\bar{A} \cap B)$
12. If X is the number of tails in three tosses of a coin, determine the standard deviation of X.
13. In a dice game, a player pays a stake of Re1 for each throw of a die. She receives Rs 5 if the die shows a 3, Rs 2 if the die shows a 1 or 6, and nothing

otherwise. What is the player's expected profit per throw over a long series of throws?

14. Three dice are thrown at the sametime. Find the probability of getting three two's, if it is known that the sum of the numbers on the dice was six.
15. Suppose 10,000 tickets are sold in a lottery each for Re 1. First prize is of Rs 3000 and the second prize is of Rs. 2000. There are three third prizes of Rs. 500 each. If you buy one ticket, what is your expectation.
16. A bag contains 4 white and 5 black balls. Another bag contains 9 white and 7 black balls. A ball is transferred from the first bag to the second and then a ball is drawn at random from the second bag. Find the probability that the ball drawn is white.
17. Bag I contains 3 black and 2 white balls, Bag II contains 2 black and 4 white balls. A bag and a ball is selected at random. Determine the probability of selecting a black ball.
18. A box has 5 blue and 4 red balls. One ball is drawn at random and not replaced. Its colour is also not noted. Then another ball is drawn at random. What is the probability of second ball being blue?
19. Four cards are successively drawn without replacement from a deck of 52 playing cards. What is the probability that all the four cards are kings?
20. A die is thrown 5 times. Find the probability that an odd number will come up exactly three times.
21. Ten coins are tossed. What is the probability of getting at least 8 heads?
22. The probability of a man hitting a target is 0.25. He shoots 7 times. What is the probability of his hitting at least twice?
23. A lot of 100 watches is known to have 10 defective watches. If 8 watches are selected (one by one with replacement) at random, what is the probability that there will be at least one defective watch?

24. Consider the probability distribution of a random variable X:

X	0	1	2	3	4
P(X)	0.1	0.25	0.3	0.2	0.15

Calculate (i) $V\left(\frac{X}{2}\right)$ (ii) Variance of X.

25. The probability distribution of a random variable X is given below:

X	0	1	2	3
P(X)	k	$\frac{k}{2}$	$\frac{k}{4}$	$\frac{k}{8}$

- (i) Determine the value of k .
 (ii) Determine $P(X \leq 2)$ and $P(X > 2)$
 (iii) Find $P(X \leq 2) + P(X > 2)$.
26. For the following probability distribution determine standard deviation of the random variable X.

X	2	3	4
P(X)	0.2	0.5	0.3

27. A biased die is such that $P(4) = \frac{1}{10}$ and other scores being equally likely. The die is tossed twice. If X is the 'number of fours seen', find the variance of the random variable X.
28. A die is thrown three times. Let X be 'the number of twos seen'. Find the expectation of X.
29. Two biased dice are thrown together. For the first die $P(6) = \frac{1}{2}$, the other scores being equally likely while for the second die, $P(1) = \frac{2}{5}$ and the other scores are

equally likely. Find the probability distribution of ‘the number of ones seen’.

30. Two probability distributions of the discrete random variable X and Y are given below.

X	0	1	2	3
P(X)	$\frac{1}{5}$	$\frac{2}{5}$	$\frac{1}{5}$	$\frac{1}{5}$

Y	0	1	2	3
P(Y)	$\frac{1}{5}$	$\frac{3}{10}$	$\frac{2}{5}$	$\frac{1}{10}$

Prove that $E(Y^2) = 2 E(X)$.

31. A factory produces bulbs. The probability that any one bulb is defective is $\frac{1}{50}$ and they are packed in boxes of 10. From a single box, find the probability that
- none of the bulbs is defective
 - exactly two bulbs are defective
 - more than 8 bulbs work properly
32. Suppose you have two coins which appear identical in your pocket. You know that one is fair and one is 2-headed. If you take one out, toss it and get a head, what is the probability that it was a fair coin?
33. Suppose that 6% of the people with blood group O are left handed and 10% of those with other blood groups are left handed 30% of the people have blood group O. If a left handed person is selected at random, what is the probability that he/she will have blood group O?
34. Two natural numbers r, s are drawn one at a time, without replacement from the set $S = \{1, 2, 3, \dots, n\}$. Find $P[r \leq p | s \leq p]$, where $p \in S$.
35. Find the probability distribution of the maximum of the two scores obtained when a die is thrown twice. Determine also the mean of the distribution.
36. The random variable X can take only the values 0, 1, 2. Given that $P(X = 0) = P(X = 1) = p$ and that $E(X^2) = E[X]$, find the value of p .

37. Find the variance of the distribution:

x	0	1	2	3	4	5
$P(x)$	$\frac{1}{6}$	$\frac{5}{18}$	$\frac{2}{9}$	$\frac{1}{6}$	$\frac{1}{9}$	$\frac{1}{18}$

38. A and B throw a pair of dice alternately. A wins the game if he gets a total of 6 and B wins if she gets a total of 7. It A starts the game, find the probability of winning the game by A in third throw of the pair of dice.
39. Two dice are tossed. Find whether the following two events A and B are independent:

$$A = (x, y) : x+y=11 \quad B = (x, y) : x = 5$$

where (x, y) denotes a typical sample point.

40. An urn contains m white and n black balls. A ball is drawn at random and is put back into the urn along with k additional balls of the same colour as that of the ball drawn. A ball is again drawn at random. Show that the probability of drawing a white ball now does not depend on k .

Long Answer (L.A.)

41. Three bags contain a number of red and white balls as follows:
 Bag 1 : 3 red balls, Bag 2 : 2 red balls and 1 white ball
 Bag 3 : 3 white balls.

The probability that bag i will be chosen and a ball is selected from it is $\frac{i}{6}$,

$i = 1, 2, 3$. What is the probability that

(i) a red ball will be selected? (ii) a white ball is selected?

42. Refer to Question 41 above. If a white ball is selected, what is the probability that it came from

(i) Bag 2 (ii) Bag 3

43. A shopkeeper sells three types of flower seeds A_1 , A_2 and A_3 . They are sold as a mixture where the proportions are 4:4:2 respectively. The germination rates of the three types of seeds are 45%, 60% and 35%. Calculate the probability

(i) of a randomly chosen seed to germinate

- (ii) that it will not germinate given that the seed is of type A_3 ,
- (iii) that it is of the type A_2 given that a randomly chosen seed does not germinate.
44. A letter is known to have come either from TATA NAGAR or from CALCUTTA. On the envelope, just two consecutive letter TA are visible. What is the probability that the letter came from TATA NAGAR.
45. There are two bags, one of which contains 3 black and 4 white balls while the other contains 4 black and 3 white balls. A die is thrown. If it shows up 1 or 3, a ball is taken from the 1st bag; but it shows up any other number, a ball is chosen from the second bag. Find the probability of choosing a black ball.
46. There are three urns containing 2 white and 3 black balls, 3 white and 2 black balls, and 4 white and 1 black balls, respectively. There is an equal probability of each urn being chosen. A ball is drawn at random from the chosen urn and it is found to be white. Find the probability that the ball drawn was from the second urn.
47. By examining the chest X ray, the probability that TB is detected when a person is actually suffering is 0.99. The probability of an healthy person diagnosed to have TB is 0.001. In a certain city, 1 in 1000 people suffers from TB. A person is selected at random and is diagnosed to have TB. What is the probability that he actually has TB?
48. An item is manufactured by three machines A, B and C. Out of the total number of items manufactured during a specified period, 50% are manufactured on A, 30% on B and 20% on C. 2% of the items produced on A and 2% of items produced on B are defective, and 3% of these produced on C are defective. All the items are stored at one godown. One item is drawn at random and is found to be defective. What is the probability that it was manufactured on machine A?
49. Let X be a discrete random variable whose probability distribution is defined as follows:

$$P(X = x) = \begin{cases} k(x+1) & \text{for } x = 1, 2, 3, 4 \\ 2kx & \text{for } x = 5, 6, 7 \\ 0 & \text{otherwise} \end{cases}$$

where k is a constant. Calculate

- (i) the value of k (ii) $E(X)$ (iii) Standard deviation of X .

- 50.** The probability distribution of a discrete random variable X is given as under:

X	1	2	4	$2A$	$3A$	$5A$
$P(X)$	$\frac{1}{2}$	$\frac{1}{5}$	$\frac{3}{25}$	$\frac{1}{10}$	$\frac{1}{25}$	$\frac{1}{25}$

Calculate :

- (i) The value of A if $E(X) = 2.94$
 (ii) Variance of X .
- 51.** The probability distribution of a random variable x is given as under:

$$P(X = x) = \begin{cases} kx^2 & \text{for } x = 1, 2, 3 \\ 2kx & \text{for } x = 4, 5, 6 \\ 0 & \text{otherwise} \end{cases}$$

where k is a constant. Calculate

- (i) $E(X)$ (ii) $E(3X^2)$ (iii) $P(X \geq 4)$
- 52.** A bag contains $(2n + 1)$ coins. It is known that n of these coins have a head on both sides where as the rest of the coins are fair. A coin is picked up at random from the bag and is tossed. If the probability that the toss results in a head is $\frac{31}{42}$, determine the value of n .
- 53.** Two cards are drawn successively without replacement from a well shuffled deck of cards. Find the mean and standard variation of the random variable X where X is the number of aces.
- 54.** A die is tossed twice. A 'success' is getting an even number on a toss. Find the variance of the number of successes.
- 55.** There are 5 cards numbered 1 to 5, one number on one card. Two cards are drawn at random without replacement. Let X denote the sum of the numbers on two cards drawn. Find the mean and variance of X .

Objective Type Questions

Choose the correct answer from the given four options in each of the exercises from 56 to 82.

56. If $P(A) = \frac{4}{5}$, and $P(A \cap B) = \frac{7}{10}$, then $P(B | A)$ is equal to
 (A) $\frac{1}{10}$ (B) $\frac{1}{8}$ (C) $\frac{7}{8}$ (D) $\frac{17}{20}$
57. If $P(A \cap B) = \frac{7}{10}$ and $P(B) = \frac{17}{20}$, then $P(A | B)$ equals
 (A) $\frac{14}{17}$ (B) $\frac{17}{20}$ (C) $\frac{7}{8}$ (D) $\frac{1}{8}$
58. If $P(A) = \frac{3}{10}$, $P(B) = \frac{2}{5}$ and $P(A \cup B) = \frac{3}{5}$, then $P(B | A) + P(A | B)$ equals
 (A) $\frac{1}{4}$ (B) $\frac{1}{3}$ (C) $\frac{5}{12}$ (D) $\frac{7}{2}$
59. If $P(A) = \frac{2}{5}$, $P(B) = \frac{3}{10}$ and $P(A \cap B) = \frac{1}{5}$, then $P(A | B) \cdot P(B' | A')$ is equal to
 (A) $\frac{5}{6}$ (B) $\frac{5}{7}$ (C) $\frac{25}{42}$ (D) 1
60. If A and B are two events such that $P(A) = \frac{1}{2}$, $P(B) = \frac{1}{3}$, $P(A/B) = \frac{1}{4}$, then $P(A' \cap B')$ equals
 (A) $\frac{1}{12}$ (B) $\frac{3}{4}$ (C) $\frac{1}{4}$ (D) $\frac{3}{16}$

61. If $P(A) = 0.4$, $P(B) = 0.8$ and $P(B | A) = 0.6$, then $P(A \cup B)$ is equal to
 (A) 0.24 (B) 0.3 (C) 0.48 (D) 0.96
62. If A and B are two events and $A \cap B = \phi$, then
 (A) $P(A | B) = P(A) \cdot P(B)$ (B) $P(A | B) = \frac{P(A \cap B)}{P(B)}$
 (C) $P(A | B) \cdot P(B | A) = 1$ (D) $P(A | B) = P(A) \cdot P(B)$
63. A and B are events such that $P(A) = 0.4$, $P(B) = 0.3$ and $P(A \cup B) = 0.5$.
 Then $P(B | A)$ equals
 (A) $\frac{2}{3}$ (B) $\frac{1}{2}$ (C) $\frac{3}{10}$ (D) $\frac{1}{5}$
64. You are given that A and B are two events such that $P(B) = \frac{3}{5}$, $P(A | B) = \frac{1}{2}$ and
 $P(A \cup B) = \frac{4}{5}$, then $P(A)$ equals
 (A) $\frac{3}{10}$ (B) $\frac{1}{5}$ (C) $\frac{1}{2}$ (D) $\frac{3}{5}$
65. In Exercise 64 above, $P(B | A)$ is equal to
 (A) $\frac{1}{5}$ (B) $\frac{3}{10}$ (C) $\frac{1}{2}$ (D) $\frac{3}{5}$
66. If $P(B) = \frac{3}{5}$, $P(A | B) = \frac{1}{2}$ and $P(A \cup B) = \frac{4}{5}$, then $P(A \cup B) + P(A \cap B) =$
 (A) $\frac{1}{5}$ (B) $\frac{4}{5}$ (C) $\frac{1}{2}$ (D) 1

67. Let $P(A) = \frac{7}{13}$, $P(B) = \frac{9}{13}$ and $P(A \cap B) = \frac{4}{13}$. Then $P(A | B)$ is equal to
- (A) $\frac{6}{13}$ (B) $\frac{4}{13}$ (C) $\frac{4}{9}$ (D) $\frac{5}{9}$
68. If A and B are such events that $P(A) > 0$ and $P(B) \neq 1$, then $P(A | B)$ equals.
- (A) $1 - P(A | B)$ (B) $1 - P(A \cap B)$
- (C) $\frac{1 - P(A \cup B)}{P(B)}$ (D) $P(A) | P(B)$
69. If A and B are two independent events with $P(A) = \frac{3}{5}$ and $P(B) = \frac{4}{9}$, then $P(A \cap B)$ equals
- (A) $\frac{4}{15}$ (B) $\frac{8}{45}$ (C) $\frac{1}{3}$ (D) $\frac{2}{9}$
70. If two events are independent, then
- (A) they must be mutually exclusive
- (B) the sum of their probabilities must be equal to 1
- (C) (A) and (B) both are correct
- (D) None of the above is correct
71. Let A and B be two events such that $P(A) = \frac{3}{8}$, $P(B) = \frac{5}{8}$ and $P(A \cup B) = \frac{3}{4}$. Then $P(A | B) \cdot P(A | B)$ is equal to
- (A) $\frac{2}{5}$ (B) $\frac{3}{8}$ (C) $\frac{3}{20}$ (D) $\frac{6}{25}$
72. If the events A and B are independent, then $P(A \cap B)$ is equal to

- (A) $P(A) + P(B)$ (B) $P(A) - P(B)$
 (C) $P(A) \cdot P(B)$ (D) $P(A) | P(B)$
- 73.** Two events E and F are independent. If $P(E) = 0.3$, $P(E \cup F) = 0.5$, then $P(E | F) - P(F | E)$ equals
- (A) $\frac{2}{7}$ (B) $\frac{3}{35}$ (C) $\frac{1}{70}$ (D) $\frac{1}{7}$
- 74.** A bag contains 5 red and 3 blue balls. If 3 balls are drawn at random without replacement the probability of getting exactly one red ball is
- (A) $\frac{45}{196}$ (B) $\frac{135}{392}$ (C) $\frac{15}{56}$ (D) $\frac{15}{29}$
- 75.** Refer to Question 74 above. The probability that exactly two of the three balls were red, the first ball being red, is
- (A) $\frac{1}{3}$ (B) $\frac{4}{7}$ (C) $\frac{15}{28}$ (D) $\frac{5}{28}$
- 76.** Three persons, A, B and C, fire at a target in turn, starting with A. Their probability of hitting the target are 0.4, 0.3 and 0.2 respectively. The probability of two hits is
- (A) 0.024 (B) 0.188 (C) 0.336 (D) 0.452
- 77.** Assume that in a family, each child is equally likely to be a boy or a girl. A family with three children is chosen at random. The probability that the eldest child is a girl given that the family has at least one girl is
- (A) $\frac{1}{2}$ (B) $\frac{1}{3}$ (C) $\frac{2}{3}$ (D) $\frac{4}{7}$
- 78.** A die is thrown and a card is selected at random from a deck of 52 playing cards. The probability of getting an even number on the die and a spade card is
- (A) $\frac{1}{2}$ (B) $\frac{1}{4}$ (C) $\frac{1}{8}$ (D) $\frac{3}{4}$

79. A box contains 3 orange balls, 3 green balls and 2 blue balls. Three balls are drawn at random from the box without replacement. The probability of drawing 2 green balls and one blue ball is
- (A) $\frac{3}{28}$ (B) $\frac{2}{21}$ (C) $\frac{1}{28}$ (D) $\frac{167}{168}$
80. A flashlight has 8 batteries out of which 3 are dead. If two batteries are selected without replacement and tested, the probability that both are dead is
- (A) $\frac{33}{56}$ (B) $\frac{9}{64}$ (C) $\frac{1}{14}$ (D) $\frac{3}{28}$
81. Eight coins are tossed together. The probability of getting exactly 3 heads is
- (A) $\frac{1}{256}$ (B) $\frac{7}{32}$ (C) $\frac{5}{32}$ (D) $\frac{3}{32}$
82. Two dice are thrown. If it is known that the sum of numbers on the dice was less than 6, the probability of getting a sum 3, is
- (A) $\frac{1}{18}$ (B) $\frac{5}{18}$ (C) $\frac{1}{5}$ (D) $\frac{2}{5}$
83. Which one is not a requirement of a binomial distribution?
- (A) There are 2 outcomes for each trial
(B) There is a fixed number of trials
(C) The outcomes must be dependent on each other
(D) The probability of success must be the same for all the trials
84. Two cards are drawn from a well shuffled deck of 52 playing cards with replacement. The probability, that both cards are queens, is
- (A) $\frac{1}{13} \times \frac{1}{13}$ (B) $\frac{1}{13} + \frac{1}{13}$ (C) $\frac{1}{13} \times \frac{1}{17}$ (D) $\frac{1}{13} \times \frac{4}{51}$
85. The probability of guessing correctly at least 8 out of 10 answers on a true-false type examination is

(A) $\frac{7}{64}$ (B) $\frac{7}{128}$ (C) $\frac{45}{1024}$ (D) $\frac{7}{41}$

86. The probability that a person is not a swimmer is 0.3. The probability that out of 5 persons 4 are swimmers is

(A) ${}^5C_4 (0.7)^4 (0.3)$ (B) ${}^5C_1 (0.7) (0.3)^4$
 (C) ${}^5C_4 (0.7) (0.3)^4$ (D) $(0.7)^4 (0.3)$

87. The probability distribution of a discrete random variable X is given below:

X	2	3	4	5
P(X)	$\frac{5}{k}$	$\frac{7}{k}$	$\frac{9}{k}$	$\frac{11}{k}$

The value of k is

(A) 8 (B) 16 (C) 32 (D) 48

88. For the following probability distribution:

X	-4	-3	-2	-1	0
P(X)	0.1	0.2	0.3	0.2	0.2

E(X) is equal to :

(A) 0 (B) -1 (C) -2 (D) -1.8

89. For the following probability distribution

X	1	2	3	4
P(X)	$\frac{1}{10}$	$\frac{1}{5}$	$\frac{3}{10}$	$\frac{2}{5}$

E(X²) is equal to

(A) 3 (B) 5 (C) 7 (D) 10

90. Suppose a random variable X follows the binomial distribution with parameters n and p , where $0 < p < 1$. If $P(x = r) / P(x = n - r)$ is independent of n and r , then p equals

(A) $\frac{1}{2}$ (B) $\frac{1}{3}$ (C) $\frac{1}{5}$ (D) $\frac{1}{7}$

91. In a college, 30% students fail in physics, 25% fail in mathematics and 10% fail in both. One student is chosen at random. The probability that she fails in physics if she has failed in mathematics is

(A) $\frac{1}{10}$ (B) $\frac{2}{5}$ (C) $\frac{9}{20}$ (D) $\frac{1}{3}$

92. A and B are two students. Their chances of solving a problem correctly are $\frac{1}{3}$ and $\frac{1}{4}$, respectively. If the probability of their making a common error is, $\frac{1}{20}$ and they obtain the same answer, then the probability of their answer to be correct is

(A) $\frac{1}{12}$ (B) $\frac{1}{40}$ (C) $\frac{13}{120}$ (D) $\frac{10}{13}$

93. A box has 100 pens of which 10 are defective. What is the probability that out of a sample of 5 pens drawn one by one with replacement at most one is defective?

(A) $\left(\frac{9}{10}\right)^5$ (B) $\frac{1}{2}\left(\frac{9}{10}\right)^4$ (C) $\frac{1}{2}\left(\frac{9}{10}\right)^5$ (D) $\left(\frac{9}{10}\right)^5 + \frac{1}{2}\left(\frac{9}{10}\right)^4$

State True or False for the statements in each of the Exercises 94 to 103.

94. Let $P(A) > 0$ and $P(B) > 0$. Then A and B can be both mutually exclusive and independent.
95. If A and B are independent events, then \bar{A} and \bar{B} are also independent.
96. If A and B are mutually exclusive events, then they will be independent also.
97. Two independent events are always mutually exclusive.
98. If A and B are two independent events then $P(A \text{ and } B) = P(A).P(B)$.

99. Another name for the mean of a probability distribution is expected value.

100. If A and B' are independent events, then $P(A' \cup B) = 1 - P(A)P(B')$

101. If A and B are independent, then

$$P(\text{exactly one of A, B occurs}) = P(A)P(B) + P(B)P(A)$$

102. If A and B are two events such that $P(A) > 0$ and $P(A) + P(B) > 1$, then

$$P(B | A) \geq 1 - \frac{P(B')}{P(A)}$$

103. If A, B and C are three independent events such that $P(A) = P(B) = P(C) = p$, then

$$P(\text{At least two of A, B, C occur}) = 3p^2 - 2p^3$$

Fill in the blanks in each of the following questions:

104. If A and B are two events such that

$$P(A | B) = p, P(A) = p, P(B) = \frac{1}{3}$$

and $P(A \cup B) = \frac{5}{9}$, then $p =$ _____

105. If A and B are such that

$$P(A' \cup B') = \frac{2}{3} \text{ and } P(A \cup B) = \frac{5}{9},$$

then $P(A') + P(B') =$

106. If X follows binomial distribution with parameters $n = 5$, p and $P(X = 2) = 9$, $P(X = 3)$, then $p =$ _____

107. Let X be a random variable taking values x_1, x_2, \dots, x_n with probabilities p_1, p_2, \dots, p_n , respectively. Then $\text{var}(X) =$ _____

108. Let A and B be two events. If $P(A | B) = P(A)$, then A is _____ of B.



DESIGN OF THE QUESTION PAPER

MATHEMATICS – CLASS XII

Time : 3 Hours

Max. Marks : 100

The weightage of marks over different dimensions of the question paper shall be as follows:

(A) Weightage to different topics/content units

S.No.	Topic	Marks
1.	Relations and functions	10
2.	Algebra	13
3.	Calculus	44
4.	Vectors and three-dimensional geometry	17
5.	Linear programming	06
6.	Probability	10
	Total	100

(B) Weightage to different forms of questions:

S.No.	Form of Questions	Marks for each Question	Total No. of Questions	Total Marks
1.	MCQ/Objective type/VSA	01	10	10
2.	Short Answer Questions	04	12	48
3.	Long Answer Questions	06	07	42
	Total		29	100

(C) Scheme of Option

There is no overall choice. However, an internal choice in four questions of four marks each and two questions of six marks each has been provided.

Blue Print

Units/Type of Question	MCQ/VSA	S.A.	L.A.	Total
Relations and functions	2(2)	8 (2)	–	10 (4)
Algebra	3 (3)	4 (1)	6 (1)	13 (5)
Calculus	2 (2)	24(6)	18(3)	44 (11)
Vectors and 3-dimensional geometry	3 (3)	8 (2)	6 (1)	17 (6)
Linear programming	–	–	6 (1)	6 (1)
Probability	–	4 (1)	6 (1)	10 (2)
Total	10 (10)	48 (12)	42 (7)	100 (29)

Section–A

Choose the correct answer from the given four options in each of the Questions 1 to 3.

1. If $*$ is a binary operation given by $*$: $\mathbf{R} \times \mathbf{R} \rightarrow \mathbf{R}$, $a * b = a + b^2$, then $-2*5$ is
 (A) -52 (B) 23 (C) 64 (D) 13

2. If $\sin^{-1} : [-1, 1] \rightarrow \left[\frac{\pi}{2}, \frac{3\pi}{2} \right]$ is a function, then value of $\sin^{-1} \left(-\frac{1}{2} \right)$ is

- (A) $\frac{-\pi}{6}$ (B) $\frac{-\pi}{6}$ (C) $\frac{5\pi}{6}$ (D) $\frac{7\pi}{6}$

3. Given that $\begin{pmatrix} 9 & 6 \\ 3 & 0 \end{pmatrix} = \begin{pmatrix} 2 & 3 \\ 1 & 0 \end{pmatrix} \begin{pmatrix} 3 & 0 \\ 1 & 2 \end{pmatrix}$. Applying elementary row transformation $R_1 \rightarrow R_1 - 2R_2$ on both sides, we get

- (A) $\begin{pmatrix} 3 & 6 \\ 3 & 0 \end{pmatrix} = \begin{pmatrix} 2 & 3 \\ 1 & 0 \end{pmatrix} \begin{pmatrix} 1 & -4 \\ 1 & 2 \end{pmatrix}$ (B) $\begin{pmatrix} 3 & 6 \\ 3 & 0 \end{pmatrix} = \begin{pmatrix} 0 & 3 \\ 1 & 0 \end{pmatrix} \begin{pmatrix} 3 & 0 \\ 1 & 2 \end{pmatrix}$
 (C) $\begin{pmatrix} -3 & 6 \\ 3 & 0 \end{pmatrix} = \begin{pmatrix} 2 & 3 \\ 1 & 0 \end{pmatrix} \begin{pmatrix} 3 & 0 \\ -3 & 2 \end{pmatrix}$ (D) $\begin{pmatrix} -3 & 6 \\ 3 & 0 \end{pmatrix} = \begin{pmatrix} -4 & 3 \\ 1 & 0 \end{pmatrix} \begin{pmatrix} 3 & 0 \\ 1 & 2 \end{pmatrix}$

4. If A is a square matrix of order 3 and $|A| = 5$, then what is the value of $|\text{Adj. A}|$?
 5. If A and B are square matrices of order 3 such that $|A| = -1$ and $|B| = 4$, then what is the value of $|3(AB)|$?

6. The degree of the differential equation $\left[1 + \left(\frac{dy}{dx} \right)^3 \right] = \left(\frac{d^2y}{dx^2} \right)^2$ is _____.

Fill in the blanks in each of the Questions 7 and 8:

7. The integrating factor for solving the linear differential equation $x \frac{dy}{dx} - y = x^2$ is _____.

8. The value of $|\hat{i} - \hat{j}|^2$ is _____.
9. What is the distance between the planes $3x + 4y - 7 = 0$ and $6x + 8y + 6 = 0$?
10. If \vec{a} is a unit vector and $(\vec{x} - \vec{a}) \cdot (\vec{x} + \vec{a}) = 99$, then what is the value of $|\vec{x}|$?

Section-B

11. Let n be a fixed positive integer and R be the relation in \mathbf{Z} defined as $a R b$ if and only if $a - b$ is divisible by n , $\forall a, b \in \mathbf{Z}$. Show that R is an equivalence relation.
12. Prove that $\cot^{-1}7 + \cot^{-1}8 + \cot^{-1}18 = \cot^{-1}3$.

OR

Solve the equation $\tan^{-1}(2+x) + \tan^{-1}(2-x) = \tan^{-1}\frac{2}{3}$, $-\sqrt{3} > x > \sqrt{3}$.

13. Solve for x , $\begin{vmatrix} x+2 & x+6 & x-1 \\ x+6 & x-1 & x+2 \\ x-1 & x+2 & x+6 \end{vmatrix} = 0$

OR

If $A = \begin{pmatrix} 1 & 2 \\ 3 & 4 \end{pmatrix}$ and $B = \begin{pmatrix} 1 & -1 & 2 \\ 3 & 2 & -3 \end{pmatrix}$, verify that $(AB)' = B' A'$.

14. Determine the value of k so that the function:

$$f(x) = \begin{cases} \frac{k \cdot \cos 2x}{\pi - 4x}, & \text{if } x \neq \frac{\pi}{4} \\ 5, & \text{if } x = \frac{\pi}{4} \end{cases}$$

is continuous at $x = \frac{\pi}{4}$.

15. If $y = e^{a \cos^{-1} x}$, show that $(1 - x^2) \frac{d^2 y}{dx^2} - x \frac{dy}{dx} - a^2 y = 0$.

16. Find the equation of the tangent to the curve $x = \sin 3t$, $y = \cos 2t$ at $t = \frac{\pi}{4}$.

Find the intervals in which the function $f(x) = \sin^4 x + \cos^4 x$, $0 < x < \frac{\pi}{2}$, is strictly increasing or strictly decreasing.

17. Evaluate $\int_0^{\frac{\pi}{6}} \sin^4 x \cos^3 x dx$

18. Evaluate $\int \frac{3x+1}{2x^2-2x+3} dx$

OR

Evaluate $\int x(\log x)^2 dx$

19. Find a particular solution of the differential equation

$$2y e^{\frac{x}{y}} dx + (y - 2x e^{\frac{x}{y}}) dy = 0, \text{ given that } x = 0 \text{ when } y = 1.$$

20. If $\vec{a} = 2\hat{i} - 2\hat{j} + \hat{k}$, $\vec{b} = \hat{i} + 2\hat{j} - 3\hat{k}$ and $\vec{c} = 2\hat{i} - \hat{j} + 4\hat{k}$, then find the projection of $\vec{b} + \vec{c}$ along \vec{a} .

21. Determine the vector equation of a line passing through $(1, 2, -4)$ and perpendicular to the two lines $\vec{r} = (8\hat{i} - 16\hat{j} + 10\hat{k}) + \lambda(3\hat{i} - 16\hat{j} + 7\hat{k})$ and $(15\hat{i} + 29\hat{j} + 5\hat{k}) + \mu(3\hat{i} + 8\hat{j} - 5\hat{k})$.

22. There are three coins. One is a biased coin that comes up with tail 60% of the times, the second is also a biased coin that comes up heads 75% of the times and the third is an unbiased coin. One of the three coins is chosen at random and tossed, it showed heads. What is the probability that it was the unbiased coin?

SECTION-C

23. Find A^{-1} , where $A = \begin{pmatrix} 4 & 1 & 3 \\ 2 & 1 & 1 \\ 3 & 1 & -2 \end{pmatrix}$. Hence solve the following system of equations $4x + 2y + 3z = 2$, $x + y + z = 1$, $3x + y - 2z = 5$,

OR

Using elementary transformations, find A^{-1} , where

$$A = \begin{pmatrix} 1 & 2 & -2 \\ -1 & 3 & 0 \\ 0 & -2 & 1 \end{pmatrix}$$

24. Show that the semi-vertical angle of the cone of maximum volume and of given slant height is $\tan^{-1}\sqrt{2}$.
25. Evaluate $\int_1^3 (3x^2 + 2x + 5) dx$ by the method of limit of sum.
26. Find the area of the triangle formed by positive x -axis, and the normal and tangent to the circle $x^2 + y^2 = 4$ at $(1, \sqrt{3})$, using integration.
27. Find the equation of the plane through the intersection of the planes $x + 3y + 6 = 0$ and $3x - y - 4z = 0$ and whose perpendicular distance from origin is unity.

OR

Find the distance of the point $(3, 4, 5)$ from the plane $x + y + z = 2$ measured parallel to the line $2x = y = z$.

28. Four defective bulbs are accidentally mixed with six good ones. If it is not possible to just look at a bulb and tell whether or not it is defective, find the probability distribution of the number of defective bulbs, if four bulbs are drawn at random from this lot.

29. A furniture firm manufactures chairs and tables, each requiring the use of three machines A, B and C. Production of one chair requires 2 hours on machine A, 1 hour on machine B and 1 hour on machine C. Each table requires 1 hour each on machine A and B and 3 hours on machine C. The profit obtained by selling one chair is Rs 30 while by selling one table the profit is Rs 60. The total time available per week on machine A is 70 hours, on machine B is 40 hours and on machine C is 90 hours. How many chairs and tables should be made per week so as to maximise profit? Formulate the problems as a L.P.P. and solve it graphically.

Marking Scheme

Section-A

1. (B)	2. (D)	3. (B)		
4. 25	5. -108	6. 2	7. $\frac{1}{x}$	Marks
8. 2	9. 2 Units	10. 10		$1 \times 10 = 10$

Sections-B

- 11.** (i) Since $a R a, \forall a \in \mathbf{Z}$, and because 0 is divisible by n , therefore R is reflexive. 1
- (ii) $a R b \Rightarrow a - b$ is divisible by n , then $b - a$, is divisible by n , so $b R a$.
Hence R is symmetric. 1
- (iii) Let $a R b$ and $b R c$, for $a, b, c, \in \mathbf{Z}$. Then $a - b = n p, b - c = n q$,
for some $p, q \in \mathbf{Z}$
- Therefore, $a - c = n (p + q)$ and so $a R c$. 1
- Hence R is reflexive and so equivalence relation. 1
- 12.** LHS = $\tan^{-1} \frac{1}{7} + \tan^{-1} \frac{1}{8} + \tan^{-1} \frac{1}{18}$ 1
- $$= \tan^{-1} \frac{\frac{1}{7} + \frac{1}{8}}{1 - \frac{1}{7} \cdot \frac{1}{8}} + \tan^{-1} \frac{1}{18} = \tan^{-1} \left(\frac{15}{55} \right) + \tan^{-1} \frac{1}{18}$$
- 1
- $$= \tan^{-1} \frac{3}{11} + \tan^{-1} \frac{1}{18} = \tan^{-1} \frac{\frac{3}{11} + \frac{1}{18}}{1 - \frac{3}{11} \cdot \frac{1}{18}} = \tan^{-1} \frac{65}{195}$$
- 1
- $$= \tan^{-1} \frac{1}{3} = \cot^{-1} 3 = \text{RHS}$$
- 1

OR

Since $\tan^{-1}(2+x) + \tan^{-1}(2-x) = \tan^{-1} \frac{2}{3}$

Therefore, $\tan^{-1} \frac{(2+x) + (2-x)}{1-(2+x)(2-x)} = \tan^{-1} \frac{2}{3}$ 1½

Thus $\frac{4}{x^2-3} = \frac{2}{3}$ 1½

$\Rightarrow x^2 = 9 \Rightarrow x = \pm 3$ 1

13. Given, $\begin{vmatrix} x+2 & x+6 & x-1 \\ x+6 & x-1 & x+2 \\ x-1 & x+2 & x+6 \end{vmatrix} = 0$

Using $\begin{matrix} R_2 \rightarrow R_2 - R_1 \\ R_3 \rightarrow R_3 - R_1 \end{matrix}$, we get $\begin{vmatrix} x+2 & x+6 & x-1 \\ 4 & -7 & 3 \\ -3 & -4 & 7 \end{vmatrix} = 0$ 1½

Using $\begin{matrix} C_2 \rightarrow C_2 - C_1 \\ C_3 \rightarrow C_3 - C_1 \end{matrix}$, we get $\begin{vmatrix} x+2 & 4 & -3 \\ 4 & -11 & -1 \\ -3 & -1 & 10 \end{vmatrix} = 0$ 1½

Therefore, $(x+2)(-111) - 4(37) - 3(-37) = 0$

which on solving gives $x = -\frac{7}{3}$ 1

OR

$AB = \begin{pmatrix} 1 & 2 \\ 3 & 4 \end{pmatrix} \begin{pmatrix} 1 & -1 & 2 \\ 3 & 2 & -3 \end{pmatrix} = \begin{pmatrix} 7 & 3 & -4 \\ 15 & 5 & -6 \end{pmatrix}$ 1

Therefore,
$$\text{LHS} = (AB)' = \begin{pmatrix} 7 & 15 \\ 3 & 5 \\ -4 & -6 \end{pmatrix} \quad 1$$

$$\text{RHS} = B' A' = \begin{pmatrix} 1 & 3 \\ -1 & 2 \\ 2 & -3 \end{pmatrix} \begin{pmatrix} 1 & 3 \\ 2 & 4 \end{pmatrix} = \begin{pmatrix} 7 & 15 \\ 3 & 5 \\ -4 & -6 \end{pmatrix} \text{ and hence LHS} = \text{RHS}$$

1+1

14. Since f is continuous at $x = \frac{\pi}{4}$, we have $\lim_{x \rightarrow \frac{\pi}{4}} f(x) = 5$.

Now
$$\lim_{x \rightarrow \frac{\pi}{4}} f(x) = \lim_{x \rightarrow \frac{\pi}{4}} \frac{k \cos 2x}{\pi - 4x} = \lim_{y \rightarrow 0} \frac{k \cos 2\left(\frac{\pi}{4} - y\right)}{\pi - 4\left(\frac{\pi}{4} - y\right)}, \text{ where } \frac{\pi}{4} - x = y, \quad 1$$

$$= \lim_{y \rightarrow 0} \frac{k \cos\left(\frac{\pi}{2} - 2y\right)}{\pi - \pi + 4y} = \lim_{y \rightarrow 0} \frac{(k \sin 2y)}{2 \cdot 2y} = \frac{k}{2} \quad 1$$

Therefore, $\frac{k}{2} = 5 \Rightarrow k = 10$. 1

15. $y = e^{a \cos^{-1} x} \Rightarrow \frac{dy}{dx} = e^{a \cos^{-1} x} \frac{(-a)}{\sqrt{1-x^2}}$ $\frac{1}{2}$

Therefore,
$$\sqrt{1-x^2} \frac{dy}{dx} = -a y \dots (1) \quad \frac{1}{2}$$

Differentiating again w.r.t. x , we get

$$\sqrt{1-x^2} \frac{d^2y}{dx^2} - \frac{x}{\sqrt{1-x^2}} \frac{dy}{dx} = -\frac{ady}{dx} \quad 1\frac{1}{2}$$

$$\Rightarrow (1-x^2) \frac{d^2y}{dx^2} - x \frac{dy}{dx} = -a \sqrt{1-x^2} \frac{dy}{dx} \quad \frac{1}{2}$$

$$= -a (-ay) \quad [\text{from 1}] \quad \frac{1}{2}$$

$$\text{Hence } (1-x^2) \frac{d^2y}{dx^2} - x \frac{dy}{dx} - a^2y = 0. \quad \frac{1}{2}$$

16. $\frac{dx}{dt} = +3\cos 3t, \frac{dy}{dt} = -2\sin 2t$ 1

Therefore, $\frac{dy}{dx} = -\frac{2\sin 2t}{3\cos 3t}$, and $\left(\frac{dy}{dx}\right)_{t=\frac{\pi}{4}} = \frac{-2\sin \frac{\pi}{2}}{3\cos 3\frac{\pi}{4}} = \frac{-2}{3 \cdot (-\frac{1}{\sqrt{2}})} = \frac{2\sqrt{2}}{3}$ 1

Also $x = \sin 3t = \sin 3 \frac{\pi}{4} = \frac{1}{\sqrt{2}}$ and $y = \cos 2t = \cos \frac{\pi}{2} = 0$.

Therefore, Point is $\left(\frac{1}{\sqrt{2}}, 0\right)$ 1

Hence, equation of tangent is $y - 0 = \frac{2\sqrt{2}}{3} \left(x - \frac{1}{\sqrt{2}}\right)$

$$2\sqrt{2} x - 3y - 2 = 0 \quad 1$$

OR

$$\begin{aligned}
 f'(x) &= 4 \sin^3 x \cos x - 4 \cos^3 x \sin x \\
 &= -4 \sin x \cos x (\cos^2 x - \sin^2 x) \\
 &= -\sin 4x. \text{ Therefore,}
 \end{aligned}
 \tag{1}$$

$$f'(x) = 0 \Rightarrow 4x = n\pi \Rightarrow x = n \frac{\pi}{4}$$

Now, for $0 < x < \frac{\pi}{4}$,

$$f'(x) < 0$$

Therefore, f is strictly decreasing in $(0, \frac{\pi}{4})$ 1½

Similarly, we can show that f is strictly increasing in $(\frac{\pi}{4}, \frac{\pi}{2})$ ½

17. $I = \int_0^{\frac{\pi}{6}} \sin^4 x \cos^3 x \, dx$

$$= \int_0^{\frac{\pi}{6}} \sin^4 x (1 - \sin^2 x) \cos x \, dx \tag{1}$$

$$= \int_0^{\frac{1}{2}} t^4 (1 - t^2) \, dt, \text{ where } \sin x = t \tag{1}$$

$$= \int_0^{\frac{1}{2}} (t^4 - t^6) \, dt = \left[\frac{t^5}{5} - \frac{t^7}{7} \right]_0^{\frac{1}{2}} \tag{1}$$

$$= \frac{1}{5} \left(\frac{1}{2} \right)^5 - \frac{1}{7} \left(\frac{1}{2} \right)^7 = \frac{1}{32} \left(\frac{1}{5} - \frac{1}{28} \right) = \frac{23}{4480} \tag{1}$$

$$18. \quad I = \int \frac{3x+1}{2x^2-2x+3} dx = \int \frac{\frac{3}{4}(4x-2) + \frac{5}{2}}{2x^2-2x+3} dx \quad 1$$

$$= \frac{3}{4} \int \frac{4x-2}{2x^2-2x+3} dx + \frac{5}{4} \int \frac{1}{x^2-x+\frac{3}{2}} dx$$

$$= \frac{3}{4} \log |2x^2-2x+3| + \frac{5}{4} \int \frac{dx}{\left(x-\frac{1}{2}\right)^2 + \left(\frac{\sqrt{5}}{2}\right)^2} \quad 1\frac{1}{2}$$

$$= \frac{3}{4} \log |2x^2-2x+3| + \frac{5}{4} \frac{2}{\sqrt{5}} \tan^{-1} \frac{2x-1}{\sqrt{5}} + c \quad 1\frac{1}{2}$$

$$= \frac{3}{4} \log |2x^2-2x+3| + \frac{\sqrt{5}}{2} \tan^{-1} \frac{2x-1}{\sqrt{5}} + c$$

OR

$$I = \int x(\log x)^2 \cdot dx = \int (\log x)^2 x dx$$

$$= (\log x)^2 \frac{x^2}{2} - \int 2 \log x \frac{1}{x} \frac{x^2}{2} dx \quad 1$$

$$= \frac{x^2}{2} (\log x)^2 - \int \log x \cdot x dx \quad \frac{1}{2}$$

$$= \frac{x^2}{2} (\log x)^2 - \left[\log x \cdot \frac{x^2}{2} - \int \frac{1}{x} \cdot \frac{x^2}{2} dx \right] \quad 1\frac{1}{2}$$

$$= \frac{x^2}{2}(\log x)^2 - \frac{x^2}{2} \log x + \frac{x^2}{4} + c \quad 1$$

19. Given differential equation can be written as

$$\frac{dx}{dy} = \frac{2xe^{\frac{x}{y}} - y}{2y \cdot e^{\frac{x}{y}}} \quad \frac{1}{2}$$

$$\text{Putting } \frac{x}{y} = v \Rightarrow x = vy \Rightarrow \frac{dx}{dy} = v + y \frac{dv}{dy} \quad \frac{1}{2}$$

$$\text{Therefore, } v + y \frac{dv}{dy} = \frac{2vye^v - y}{2ye^v} = \frac{2ve^v - 1}{2e^v} \quad \frac{1}{2}$$

$$y \frac{dv}{dy} = \frac{2ve^v - 1}{2e^v} - v \quad 1$$

$$\text{Hence } 2e^v dv = -\frac{dy}{y}$$

$$\Rightarrow 2e^v = -\log|y| + c \quad 1$$

$$\text{or } 2e^{\frac{x}{y}} = -\log|y| + c$$

$$\text{when } x = 0, \quad y = 1$$

$$\Rightarrow C = 2$$

$$\text{Therefore, the particular solution is } 2e^{\frac{x}{y}} = -\log|y| + 2 \quad \frac{1}{2}$$

20. $\vec{b} + \vec{c} = (\hat{i} + 2\hat{j} - 3\hat{k}) + (2\hat{i} - \hat{j} + 4\hat{k}) = 3\hat{i} + \hat{j} + \hat{k}$ 1

$\vec{a} = 2\hat{i} - 2\hat{j} + \hat{k}$

Projection of $(\vec{b} + \vec{c})$ along $\vec{a} = \frac{(\vec{b} + \vec{c}) \cdot \vec{a}}{|\vec{a}|}$ is 1

$\frac{6 - 2 + 1}{\sqrt{4 + 4 + 1}} = \frac{5}{3}$ units 1+1

21. A vector perpendicular to the two lines is given as

$(3\hat{i} - 16\hat{j} + 7\hat{k}) \times (3\hat{i} + 8\hat{j} - 5\hat{k}) = \begin{vmatrix} \hat{i} & \hat{j} & \hat{k} \\ 3 & -16 & 7 \\ 3 & 8 & -5 \end{vmatrix}$ 1/2

$= 24\hat{i} + 36\hat{j} + 72\hat{k}$ or $12(2\hat{i} + 3\hat{j} + 6\hat{k})$ 1

Therefore, Equation of required line is

$\vec{r} = (\hat{i} + 2\hat{j} - 4\hat{k}) + \lambda(2\hat{i} + 3\hat{j} + 6\hat{k})$ 1/2

22. Let E_1 : selection of first (biased) coin

E_2 : selection of second (biased) coin

E_3 : selection of third (unbiased) coin

$P(E_1) = P(E_2) = P(E_3) = \frac{1}{3}$ 1/2

Let A denote the event of getting a head

$$\text{Therefore, } P\left(\frac{A}{E_1}\right) = \frac{40}{100}, \quad P\left(\frac{A}{E_2}\right) = \frac{75}{100}, \quad P\left(\frac{A}{E_3}\right) = \frac{1}{2} \quad 1 \frac{1}{2}$$

$$P\left(\frac{E_3}{A}\right) = \frac{P(E_3)P\left(\frac{A}{E_3}\right)}{P(E_1)P\left(\frac{A}{E_1}\right) + P(E_2)P\left(\frac{A}{E_2}\right) + P(E_3)P\left(\frac{A}{E_3}\right)} \quad \frac{1}{2}$$

$$= \frac{\frac{1}{3} \cdot \frac{1}{2}}{\frac{1}{3} \cdot \frac{40}{100} + \frac{1}{3} \cdot \frac{75}{100} + \frac{1}{3} \cdot \frac{1}{2}} = \frac{10}{33} \quad 1 \frac{1}{2}$$

SECTION-C

$$23. |A| = 4(-3) - 1(-7) + 3(-1) = -12 + 7 - 3 = -8 \quad 1$$

$$A_{11} = -3 \quad A_{12} = 7 \quad A_{13} = -1 \quad 1 \frac{1}{2}$$

$$A_{21} = 5 \quad A_{22} = -17 \quad A_{23} = -1$$

$$A_{31} = -2 \quad A_{32} = 2 \quad A_{33} = 2$$

$$\text{Therefore, } A^{-1} = -\frac{1}{8} \begin{pmatrix} -3 & 5 & -2 \\ 7 & -17 & 2 \\ -1 & -1 & 2 \end{pmatrix} \quad \frac{1}{2}$$

Given equations can be written as

$$\begin{pmatrix} 4 & 2 & 3 \\ 1 & 1 & 1 \\ 3 & 1 & -2 \end{pmatrix} \begin{pmatrix} x \\ y \\ z \end{pmatrix} = \begin{pmatrix} 2 \\ 1 \\ 5 \end{pmatrix}$$

$$\Rightarrow A' \cdot X = B \Rightarrow X = (A'^{-1})B \quad 1$$

$$= (A^{-1})'B$$

$$\Rightarrow \begin{pmatrix} x \\ y \\ z \end{pmatrix} = \frac{-1}{8} \begin{pmatrix} -3 & 7 & -1 \\ 5 & -17 & -1 \\ -2 & 2 & 2 \end{pmatrix} \begin{pmatrix} 2 \\ 1 \\ 5 \end{pmatrix}$$

$$= -\frac{1}{8} \begin{pmatrix} -6 & +7 & -5 & = & -4 \\ 10 & -17 & -5 & = & -12 \\ -4 & +2 & +10 & = & 8 \end{pmatrix} = \begin{pmatrix} \frac{1}{2} \\ \frac{3}{2} \\ -1 \end{pmatrix} \quad 1\frac{1}{2}$$

Therefore, $x = \frac{1}{2}$, $y = \frac{3}{2}$, $z = -1$ 1/2

OR

Writing $A = \begin{pmatrix} 1 & 2 & -2 \\ -1 & 3 & 0 \\ 0 & -2 & 1 \end{pmatrix} = \begin{pmatrix} 1 & 0 & 0 \\ 0 & 1 & 0 \\ 0 & 0 & 1 \end{pmatrix} A$ 1/2

$R_2 \rightarrow R_2 + R_1 \Rightarrow \begin{pmatrix} 1 & 2 & -2 \\ 0 & 5 & -2 \\ 0 & -2 & 1 \end{pmatrix} = \begin{pmatrix} 1 & 0 & 0 \\ 1 & 1 & 0 \\ 0 & 0 & 1 \end{pmatrix} A$ 1

$R_2 \rightarrow R_2 + 2R_3 \Rightarrow \begin{pmatrix} 1 & 2 & -2 \\ 0 & 1 & 0 \\ 0 & -2 & 1 \end{pmatrix} = \begin{pmatrix} 1 & 0 & 0 \\ 1 & 1 & 2 \\ 0 & 0 & 1 \end{pmatrix} A$ 1

$$R_3 \rightarrow R_3 + 2R_2 \Rightarrow \begin{pmatrix} 1 & 2 & -2 \\ 0 & 1 & 0 \\ 0 & 0 & 1 \end{pmatrix} = \begin{pmatrix} 1 & 0 & 0 \\ 1 & 1 & 2 \\ 2 & 2 & 5 \end{pmatrix} \quad 1$$

$$R_1 \rightarrow R_1 + 2R_3 \Rightarrow \begin{pmatrix} 1 & 2 & 0 \\ 0 & 1 & 0 \\ 0 & 0 & 1 \end{pmatrix} = \begin{pmatrix} 5 & 4 & 10 \\ 1 & 1 & 2 \\ 2 & 2 & 5 \end{pmatrix} \quad A \quad 1$$

$$R_1 \rightarrow R_1 - 2R_2 \Rightarrow \begin{pmatrix} 1 & 0 & 0 \\ 0 & 1 & 0 \\ 0 & 0 & 1 \end{pmatrix} = \begin{pmatrix} 3 & 2 & 6 \\ 1 & 1 & 2 \\ 2 & 2 & 5 \end{pmatrix} \quad A \quad 1$$

$$\Rightarrow A^{-1} = \begin{pmatrix} 3 & 2 & 6 \\ 1 & 1 & 2 \\ 2 & 2 & 5 \end{pmatrix} \quad \frac{1}{2}$$

24. Volume $v = v = \frac{1}{3} \pi r^2 h$

$$l^2 = h^2 + r^2$$

$$v = \frac{1}{3} \pi (l^2 - h^2) h = \frac{1}{3} \pi (l^2 h - h^3)$$

$$\frac{dv}{dh} = \frac{\pi}{3} (l^2 - 3h^2) = 0$$

$$l = \sqrt{3}h, \quad r = \sqrt{2}h$$

$$\tan \alpha = \frac{r}{h} = \sqrt{2}$$

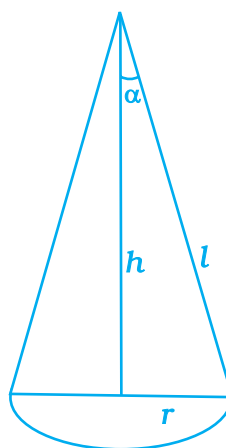

Fig. 2.1

$\frac{1}{2}$
 $\frac{1}{2}$
 $\frac{1}{2}$

$\frac{1}{2}$
 $\frac{1}{2}$

$$\alpha = \tan^{-1} \sqrt{2}$$

$$\frac{d^2v}{dh^2} = -2\pi h < 0 \quad 1$$

Therefore, v is maximum

25. $I = \int_1^3 (3x^2 + 2x + 5) dx = \int_1^3 f(x) dx$

$$= \lim_{h \rightarrow 0} h [f(1) + f(1+h) + f(1+2h) + \dots + f(1+(n-1)h)] \dots (i) \quad 1$$

where $h = \frac{3-1}{n} = \frac{2}{n}$

Now

$$f(1) = 3 + 2 + 5 = 10$$

$$f(1+h) = 3 + 3h^2 + 6h + 2 + 2h + 5 = 10 + 8h + 3h^2$$

$$f(1+2h) = 3 + 12h^2 + 12h + 2 + 4h + 5 = 10 + 8 \cdot 2h + 3 \cdot 2^2 \cdot h^2 \quad 1 \frac{1}{2}$$

$$f(1+(n-1)h) = 10 + 8(n-1)h + 3(n-1)^2 \cdot h^2$$

$$I = \lim_{n \rightarrow \infty} h \left[10n + 8h \frac{n(n-1)}{2} + 3h^2 \frac{n(n-1)(2n-1)}{6} \right] \quad 1 \frac{1}{2}$$

$$= \lim_{n \rightarrow \infty} \frac{2}{n} \left[10n + \frac{16}{n} \frac{n(n-1)}{2} + \frac{12}{n^2} \frac{n(n-1)(2n-1)}{6} \right]$$

$$\begin{aligned}
 &= \lim_{n \rightarrow \infty} \frac{2}{n} \left[10n + 8(n-1) \frac{2}{n} (n-1) (2n-1) \right] && \frac{1}{2} \\
 &= \lim_{n \rightarrow \infty} 2 \left[10 + 8 \left(1 - \frac{1}{n}\right) + 2 \left(1 - \frac{1}{n}\right) \left(2 - \frac{1}{n}\right) \right] && 1 \\
 &= 2 [10 + 8 + 4] = 44 && \frac{1}{2}
 \end{aligned}$$

26. Equation of tangent to $x^2 + y^2 = 4$ at $(1, \sqrt{3})$ is

$$x + \sqrt{3}y = 4. \text{ Therefore, } y = \frac{4-x}{\sqrt{3}}$$

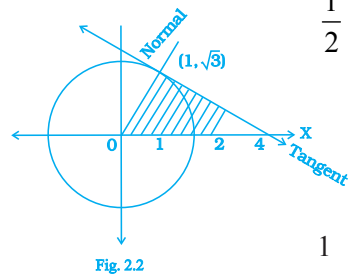

Equation of normal $y = \sqrt{3}x$ 1

Therefore, required area = $\int_0^1 \sqrt{3} x dx + \int_1^4 \frac{4-x}{\sqrt{3}} dx$ 1

$$= \left(\sqrt{3} \frac{x^2}{2} \right)_0^1 + \frac{1}{\sqrt{3}} \left(4x - \frac{x^2}{2} \right)_1^4$$
 1

$$= \frac{\sqrt{3}}{2} + \frac{1}{\sqrt{3}} \left[8 - \frac{7}{2} \right] = \frac{\sqrt{3}}{2} + \frac{3\sqrt{3}}{2} = 2\sqrt{3} \text{ sq. units}$$
 2

27. Equation of required plane is

$$(x + 3y + 6) + \lambda (3x - y - 4z) = 0$$
 1 $\frac{1}{2}$

$$\Rightarrow (1 + 3\lambda)x + (3 - \lambda)y - 4\lambda z + 6 = 0$$
 1 $\frac{1}{2}$

Perpendicular distance to the plane from origin is

Therefore, $\frac{6}{\sqrt{(1+3\lambda)^2 + (3-\lambda)^2 + (-4\lambda)^2}} = 1$ 1 $\frac{1}{2}$

or $36 = 1 + 9\lambda^2 + 6\lambda + 9 + \lambda^2 - 6\lambda + 16\lambda^2$

or $26\lambda^2 = 26 \Rightarrow \lambda = \pm 1$

Equations of required planes are

$4x + 2y - 4z + 6 = 0$ and $-2x + 4y + 4z + 6 = 0$ 1 $\frac{1}{2}$

or $2x + y - 2z + 3 = 0$ and $x - 2y - 2z - 3 = 0$ 1

OR

Equation of line is $2x = y = z$ i.e. $\frac{x}{\frac{1}{2}} = \frac{y}{1} = \frac{z}{1}$

or $\frac{x}{1} = \frac{y}{2} = \frac{z}{2}$ 1

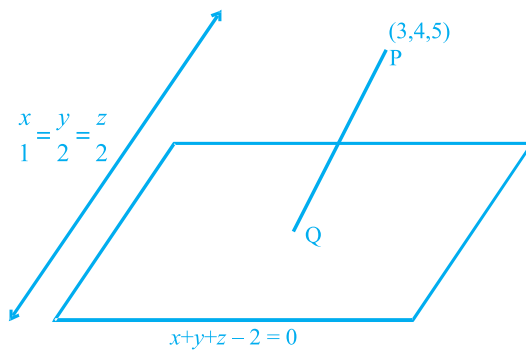

Fig. 2.3

1

Equation of line P Q is

$$\frac{x-3}{1} = \frac{y-4}{2} = \frac{z-5}{2} = \lambda \quad 1$$

$\Rightarrow Q(\lambda+3, 2\lambda+4, 2\lambda+5)$ lies on plane. Therefore,

$$\lambda+3+2\lambda+4+2\lambda+5-2=0 \quad 1 \frac{1}{2}$$

or $5\lambda = -10$ gives $\lambda = -2$ which gives the coordinates of $Q(1, 0, 1)$

$$\text{Therefore, } PQ = \sqrt{4+16+16} = 6 \text{ units} \quad 1 \frac{1}{2}$$

28. Let x denotes the number of defective bulbs

$$P(X=0) = \frac{{}^6C_4}{{}^{10}C_4} = \frac{6.5.4.3}{10.9.8.7} = \frac{1}{14} \quad 1$$

$$P(X=1) = \frac{{}^6C_3 {}^4C_1}{{}^{10}C_4} = \frac{6.5.4.4}{10.9.8.7} \cdot 4 = \frac{8}{21} \quad 1$$

$$P(X=2) = \frac{{}^6C_2 {}^6C_2}{{}^{10}C_4} = \frac{6.5.4.3}{10.9.8.7} \cdot 6 = \frac{3}{7} \quad 1$$

$$P(X=3) = \frac{{}^6C_1 {}^6C_3}{{}^{10}C_4} = \frac{6.4.3.2}{10.9.8.7} \cdot 4 = \frac{4}{35} \quad 1$$

$$P(X=4) = \frac{{}^4C_4}{{}^{10}C_4} = \frac{4.3.2.1}{10.9.8.7} = \frac{1}{210} \quad 1$$

Therefore, distribution is

X :	0	1	2	3	4
P (X) :	$\frac{1}{14}$	$\frac{8}{21}$	$\frac{3}{7}$	$\frac{4}{35}$	$\frac{1}{210}$

1

29. Let number of chairs to be made per week be x and tables be y

Thus we have to maximise $P = 30x + 60y$

Subject to

$$\begin{cases} 2x + y \leq 70 \\ x + y \leq 40 \\ x + 3y \leq 90 \\ x \geq 0, y \geq 0 \end{cases}$$

2

Vertices of feasible region are

2

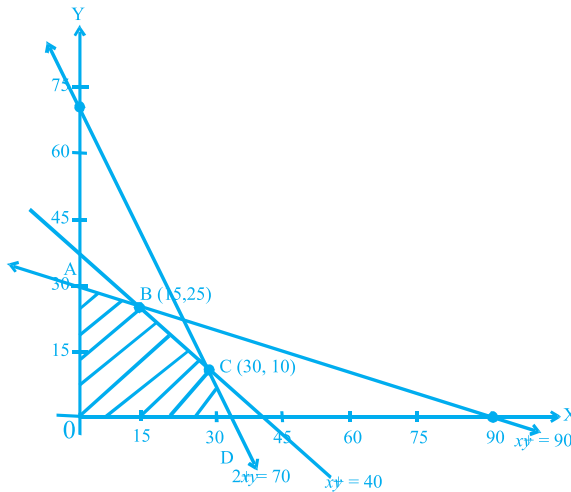

Fig. 2.4

A (0,30), B (15, 25), C (30,10), D (35, 0)

$\frac{1}{2}$

P (at A) = $30(0) + 60(30) = 1800$

P (at B) = $30(15) + 60(25) = 1950$

$$P(\text{at C}) = 30(30 + 20) = 1500$$

$$1\frac{1}{2}$$

$$P(\text{at D}) = 30(35) = 1050$$

P is Maximum for 15 chairs and 25 tables.

DESIGN OF THE QUESTION PAPER

MATHEMATICS - CLASS XII

Time : 3 Hours
Max. Marks : 100

The weightage of marks over different dimensions of the question paper shall be as follows:

(A) Weightage to different topics/content units

S.No.	Topic	Marks
1.	Relations and functions	10
2.	Algebra	13
3.	Calculus	44
4.	Vectors and three-dimensional geometry	17
5.	Linear programming	06
6.	Probability	10
Total:		100

(B) Weightage to different forms of questions:

S.No.	Form of Questions	Marks for each Question	Total Number of Questions	Marks
1.	MCQ/Objective type/VSA	01	10	10
2.	Short Answer Questions	04	12	48
3.	Long Answer Questions	06	07	42
			29	100

(C) Scheme of Option:

There is no overall choice. However, an internal choice in four questions of four marks each and two questions of six marks each has been provided.

Blue Print

Units/Type of Question	MCQ/VSA	S.A.	L.A.	Total
Relations and functions	-	4 (1)	6 (1)	10 (2)
Algebra	3 (3)	4 (1)	6 (1)	13 (5)
Calculus	4 (4)	28 (7)	12 (2)	44 (13)
Vectors and three dimensional geometry	3 (3)	8 (2)	6 (1)	17 (6)
Linear programming	-	-	6 (1)	6 (1)
Probability	-	4 (1)	6 (1)	10 (2)
Total	10 (10)	48 (12)	42 (7)	100 (29)

Section—A

Choose the correct answer from the given four options in each of the Questions 1 to 3.

1. If $\begin{vmatrix} x & y & 2 & 1 & 1 \\ x & y & 4 & 3 & 2 \end{vmatrix}$, then (x, y) is

- (A) $(1, 1)$ (B) $(1, -1)$
 (C) $(-1, 1)$ (D) $(-1, -1)$

2. The area of the triangle with vertices $(-2, 4)$, $(2, k)$ and $(5, 4)$ is 35 sq. units. The value of k is

- (A) 4 (B) -2
 (C) 6 (D) -6

3. The line $y = x + 1$ is a tangent to the curve $y^2 = 4x$ at the point

- (A) $(1, 2)$ (B) $(2, 1)$
 (C) $(1, -2)$ (D) $(-1, 2)$

4. Construct a 2×2 matrix whose elements a_{ij} are given by

$$a_{ij} = \begin{cases} \frac{|-3i + j|}{2}, & \text{if } i \neq j \\ (i + j)^2, & \text{if } i = j. \end{cases}$$

5. Find the value of derivative of $\tan^{-1}(e^x)$ w.r.t. x at the point $x = 0$.

6. The Cartesian equations of a line are $\frac{x-3}{2} = \frac{y-2}{5} = \frac{z-6}{3}$. Find the vector equation of the line.

7. Evaluate $\int (\sin^{83}x + x^{123})dx$

Fill in the blanks in Questions 8 to 10.

8. $\int \frac{\sin x + \cos x}{\sqrt{1 + \sin 2x}} dx = \underline{\hspace{2cm}}$

9. If $\vec{a} = 2\hat{i} + 4\hat{j} - \hat{k}$ and $\vec{b} = 3\hat{i} - 2\hat{j} + \hat{k}$ are perpendicular to each other, then $\lambda = \underline{\hspace{2cm}}$

10. The projection of $\vec{a} = \hat{i} + 3\hat{j} + \hat{k}$ along $\vec{b} = 2\hat{i} - 3\hat{j} + 6\hat{k}$ is $\underline{\hspace{2cm}}$

Section—B

11. Prove that $\cot^{-1} \frac{\sqrt{1 - \sin x}}{\sqrt{1 + \sin x}} = \frac{x}{2}$, $0 < x < \frac{\pi}{2}$

OR

Solve the equation for x if $\sin^{-1}x + \sin^{-1}2x = \frac{\pi}{3}$, $x > 0$

12. Using properties of determinants, prove that

$$\begin{vmatrix} b & c & c & a & a & b \\ q & r & r & p & p & q \\ y & z & z & x & x & y \end{vmatrix} = 2 \begin{vmatrix} a & b & c \\ p & q & r \\ x & y & z \end{vmatrix}$$

13. Discuss the continuity of the function f given by $f(x) = |x+1| + |x+2|$ at $x = -1$ and $x = -2$.

14. If $x = 2\cos\theta - \cos 2\theta$ and $y = 2\sin\theta - \sin 2\theta$, find $\frac{d^2y}{dx^2}$ at $\frac{\pi}{2}$.

OR

If $x\sqrt{1+y} + y\sqrt{1+x} = 0$, prove that $\frac{dy}{dx} = \frac{-1}{(1+x)^2}$, where $-1 < x < 1$

15. A cone is 10cm in diameter and 10cm deep. Water is poured into it at the rate of 4 cubic cm per minute. At what rate is the water level rising at the instant when the depth is 6cm?

OR

Find the intervals in which the function f given by $f(x) = x^3 + \frac{1}{x^3}$, $x \neq 0$ is

(i) increasing (ii) decreasing

16. Evaluate $\int \frac{3x-2}{(x-3)(x-1)^2} dx$

OR

Evaluate $\int \log(\log x) \frac{1}{(\log x)^2} dx$

17. Evaluate $\int_0^1 \frac{x \sin x}{\cos^2 x} dx$

18. Find the differential equation of all the circles which pass through the origin and whose centres lie on x -axis.

19. Solve the differential equation

$$x^2y dx - (x^3 + y^3) dy = 0$$

20. If $\vec{a} \cdot \vec{b} = \vec{a} \cdot \vec{c}$, $\vec{a} \cdot \vec{0}$ and $\vec{b} \cdot \vec{c}$, show that $\vec{b} = \vec{c} + \vec{a}$ for some scalar λ .

21. Find the shortest distance between the lines

$$\vec{r} = (\lambda - 1)\hat{i} + (\lambda + 1)\hat{j} - (1 + \lambda)\hat{k} \text{ and } \vec{r} = (1 - \lambda)\hat{i} + (2 - \lambda)\hat{j} + (\lambda - 2)\hat{k}$$

22. A card from a pack of 52 cards is lost. From the remaining cards of the pack, two cards are drawn and found to be hearts. Find the probability of the missing card to be a heart.

Section—C

23. Let the two matrices A and B be given by

$$A = \begin{pmatrix} 1 & 1 & 0 \\ 2 & 3 & 4 \\ 0 & 1 & 2 \end{pmatrix} \text{ and } B = \begin{pmatrix} 2 & 2 & 4 \\ 4 & 2 & 4 \\ 2 & 1 & 5 \end{pmatrix}$$

Verify that $AB = BA = 6I$, where I is the unit matrix of order 3 and hence solve the system of equations

$$x + y = 3, 2x + 3y + 4z = 17 \text{ and } y + 2z = 7$$

24. On the set $\mathbf{R} - \{-1\}$, a binary operation is defined by

$$a * b = a + b + ab \text{ for all } a, b \in \mathbf{R} - \{-1\}.$$

Prove that * is commutative on $\mathbf{R} - \{-1\}$. Find the identity element and prove that every element of $\mathbf{R} - \{-1\}$ is invertible.

25. Prove that the perimeter of a right angled triangle of given hypotenuse is maximum when the triangle is isosceles.

26. Using the method of integration, find the area of the region bounded by the lines

$$2x + y = 4, 3x - 2y = 6 \text{ and } x - 3y + 5 = 0.$$

OR

Evaluate $\int_1^4 (2x^2 - x)dx$ as limit of a sum.

27. Find the co-ordinates of the foot of perpendicular from the point (2, 3, 7) to the plane $3x - y - z = 7$. Also, find the length of the perpendicular.

OR

Find the equation of the plane containing the lines

$$\vec{r} = \hat{i} + \hat{j} + (\hat{i} + 2\hat{j} + \hat{k}) \text{ and } \vec{r} = \hat{i} + \hat{j} + (\hat{i} + \hat{j} + 2\hat{k}).$$

Also, find the distance of this plane from the point (1,1,1)

28. Two cards are drawn successively without replacement from well shuffled pack of 52 cards. Find the probability distribution of the number of kings. Also, calculate the mean and variance of the distribution.
29. A dietician wishes to mix two types of foods in such a way that vitamin contents of the mixture contains atleast 8 units of Vitamin A and 10 units of Vitamin C. Food 'I' contains 2 units/kg of Vitamin A and 1 unit/kg of Vitamin C. Food 'II' contains 1 unit/kg of Vitamin A and 2 units/kg of Vitamin C. It costs Rs 50 per kg to purchase Food 'I' and Rs 70 per kg to purchase Food 'II'. Formulate this problem as a linear programming problem to minimise the cost of such a mixture and solve it graphically.

Marking Scheme

Section—A

1. (C)
2. (D)
3. (A)

Marks

4. $4 \frac{1}{2}$
5. $\frac{5}{2}$ 16

5. $\frac{1}{2}$

6. $\vec{r} = (3\hat{i} - 2\hat{j} + 6\hat{k}) + \lambda(2\hat{i} - 5\hat{j} + 3\hat{k})$, where λ is a scalar.

7. 0
 8. $x + c$
 9. $\lambda = -2$
 10. $\frac{1}{7}$

$$1 \times 10 = 10$$

Sections —B

$$11. \text{ L.H.S.} = \cot^{-1} \frac{\sqrt{1 - \sin x} \sqrt{1 + \sin x}}{\sqrt{1 - \sin x} \sqrt{1 + \sin x}}$$

$$= \cot^{-1} \left\{ \frac{\sqrt{\left(\cos \frac{x}{2} + \sin \frac{x}{2}\right)^2} + \sqrt{\left(\cos \frac{x}{2} - \sin \frac{x}{2}\right)^2}}{\sqrt{\left(\cos \frac{x}{2} + \sin \frac{x}{2}\right)^2} - \sqrt{\left(\cos \frac{x}{2} - \sin \frac{x}{2}\right)^2}} \right\} \quad 1\frac{1}{2}$$

$$= \cot^{-1} \frac{\left| \cos \frac{x}{2} \right| \left| \sin \frac{x}{2} \right| \left| \cos \frac{x}{2} - \sin \frac{x}{2} \right|}{\left| \cos \frac{x}{2} \right| \left| \sin \frac{x}{2} \right| - \left| \cos \frac{x}{2} - \sin \frac{x}{2} \right|} \quad \left[\text{since } 0 < \frac{x}{2} < \frac{\pi}{4} \Rightarrow \cos \frac{x}{2} > \sin \frac{x}{2} \right]$$

$$= \cot^{-1} \frac{\cos \frac{x}{2} \sin \frac{x}{2} \cos \frac{x}{2} - \sin \frac{x}{2}}{\cos \frac{x}{2} \sin \frac{x}{2} - \cos \frac{x}{2} \sin \frac{x}{2}}$$

$$= \cot^{-1} \frac{2 \cos \frac{x}{2}}{2 \sin \frac{x}{2}} = \cot^{-1} \cot \frac{x}{2} = \frac{x}{2} \quad 1\frac{1}{2}$$

$$\left[\text{since } 0 < \frac{x}{2} < \frac{\pi}{4} \right] \quad 1$$

OR

$$\sin^{-1}x + \sin^{-1}2x = \frac{\pi}{3}$$

$$\Rightarrow \sin^{-1}2x = \frac{\pi}{3} - \sin^{-1}x$$

$$\Rightarrow 2x = \sin\left(\frac{\pi}{3} - \sin^{-1}x\right) \quad 1$$

$$= \sin \frac{\pi}{3} \cos(\sin^{-1}x) - \cos \frac{\pi}{3} \sin(\sin^{-1}x) = \frac{\sqrt{3}}{2} \sqrt{1 - \sin^2(\sin^{-1}x)} - \frac{1}{2}x$$

$$= \frac{\sqrt{3}}{2} \sqrt{1 - x^2} - \frac{1}{2}x$$

$$4x = \sqrt{3}\sqrt{1-x^2} - x, \quad 5x = \sqrt{3}\sqrt{1-x^2} \quad 1\frac{1}{2}$$

$$\Rightarrow 25x^2 = 3(1-x^2)$$

$$\Rightarrow 28x^2 = 3$$

$$\Rightarrow x^2 = \frac{3}{28}$$

$$\Rightarrow x = \frac{1}{2}\sqrt{\frac{3}{7}} \quad 1$$

$$\text{Hence } x = \frac{1}{2}\sqrt{\frac{3}{7}} \quad (\text{as } x > 0 \text{ given}) \quad \frac{1}{2}$$

Thus $x = \frac{1}{2}\sqrt{\frac{3}{7}}$ is the solution of given equation.

12. Let
$$\begin{vmatrix} b & c & c & a & a & b \\ q & r & r & p & p & q \\ y & z & z & x & x & y \end{vmatrix}$$

Using $C_1 = C_1 + C_2 + C_3$, we get

$$\begin{vmatrix} 2(a & b & c) & c & a & a & b \\ 2(p & q & r) & r & p & p & q \\ 2(x & y & z) & z & x & x & y \end{vmatrix} \quad 1$$

$$2 \begin{vmatrix} a & b & c & c & a & a & b \\ p & q & r & r & p & p & q \\ x & y & z & z & x & x & y \end{vmatrix}$$

Using $C_2 = C_2 - C_1$ and $C_3 = C_3 - C_1$, we get

$$\Delta = 2 \begin{vmatrix} a+b+c & -b & -c \\ p+q+r & -q & -r \\ x+y+z & -y & -z \end{vmatrix} \quad 1\frac{1}{2}$$

Using $C_1 = C_1 + C_2 + C_3$ and taking (-1) common from both C_2 and C_3

$$2 \begin{vmatrix} a & b & c \\ p & q & r \\ x & y & z \end{vmatrix} \qquad 1\frac{1}{2}$$

13. Case 1 when $x < -2$

$$f(x) = |x + 1| + |x + 2| = -(x + 1) - (x + 2) = -2x - 3$$

Case 2 When $-2 \leq x < -1$

$$f(x) = -x - 1 + x + 2 = 1 \qquad 1$$

Case 3 When $x \geq -1$

$$f(x) = x + 1 + x + 2 = 2x + 3$$

Thus

$$f(x) \begin{cases} -2x-3 & \text{when } x < -2 \\ 1 & \text{when } -2 \leq x < -1 \\ 2x+3 & \text{when } x \geq -1 \end{cases}$$

Now, L.H.S at $x = -2$, $\lim_{x \rightarrow -2^-} f(x) = \lim_{x \rightarrow -2^-} -2x - 3 = 4 - 3 = 1$

R.H.S at $x = -2$, $\lim_{x \rightarrow -2^+} f(x) = \lim_{x \rightarrow -2^+} 1 = 1$

Also $f(-2) = |-2 + 1| + |-2 + 2| = |-1| + |0| = 1$

Thus, $\lim_{x \rightarrow -2^-} f(x) = f(-2) = \lim_{x \rightarrow -2^+} f(x)$ 1\frac{1}{2}

\Rightarrow The function f is continuous at $x = -2$

Now, L.H.S at $x = -1$, $\lim_{x \rightarrow -1^-} f(x) = \lim_{x \rightarrow -1^-} 1 = 1$

$$\begin{aligned} \text{R.H.S at } x = -1, \lim_{x \rightarrow -1} f(x) \\ = \lim_{x \rightarrow -1} 2x + 3 = 1 \end{aligned}$$

 $1\frac{1}{2}$

Also $f(-1) = |-1 + 1| + |-1 + 2| = 1$

Thus, $\lim_{x \rightarrow -1} f(x) = \lim_{x \rightarrow -1} f(-1)$

\Rightarrow The function is continuous at $x = -1$

Hence, the given function is continuous at both the points $x = -1$ and $x = -2$

14. $x = 2\cos\theta - \cos 2\theta$ and $y = 2\sin\theta - \sin 2\theta$

$$\text{So } \frac{dy}{dx} = \frac{\frac{dy}{d\theta}}{\frac{dx}{d\theta}} = \frac{\cos\theta - \cos 2\theta}{\sin 2\theta - \sin\theta} = \frac{-2\sin\frac{3\theta}{2} \sin\left(\frac{-\theta}{2}\right)}{2\cos\frac{3\theta}{2} \sin\frac{\theta}{2}} = \tan\frac{3\theta}{2}$$

 $1\frac{1}{2}$

Differentiating both sides w.r.t. x , we get

$$\frac{d^2y}{dx^2} = \frac{3}{2} \sec^2 \frac{3}{2} \frac{d}{dx}$$

$$\frac{3}{2} \sec^2 \frac{3}{2} \frac{1}{2 \sin 2 - \sin} = \frac{3}{4} \sec^2 \frac{3}{2} \frac{1}{2 \cos \frac{3}{2} \sin \frac{\theta}{2}}$$

$$= \frac{3}{8} \sec^3 \frac{3\theta}{2} \operatorname{cosec} \frac{\theta}{2}$$

 $1\frac{1}{2}$

Thus $\frac{d^2y}{dx^2}$ at $\theta = \frac{\pi}{2}$ is $\frac{3}{8} \sec^3 \frac{3\pi}{4} \operatorname{cosec} \frac{\pi}{4} = \frac{-3}{2}$ 1

OR

We have

$$x\sqrt{1-y} - y\sqrt{1-x} = 0$$

$$\Rightarrow x\sqrt{1-y} = y\sqrt{1-x}$$

Squaring both sides, we get

$$x^2(1-y) = y^2(1-x)$$
 1

$$\Rightarrow (x+y)(x-y) = -yx(x-y)$$

$$\Rightarrow x+y = -xy, \text{ i.e., } y = \frac{-x}{1+x}$$
 2

$$\Rightarrow \frac{dy}{dx} = \frac{1-x}{1+x^2} = \frac{-1}{1+x^2}$$
 1

- 15.** Let OAB be a cone and let LM be the level of water at any time t .

Let $ON = h$ and $MN = r$

Given $AB = 10$ cm, $OC = 10$ cm and $\frac{dV}{dt} = 4$ cm³ minute, where V denotes the volume of cone OLM.

Note that $\triangle ONM \sim \triangle OCB$

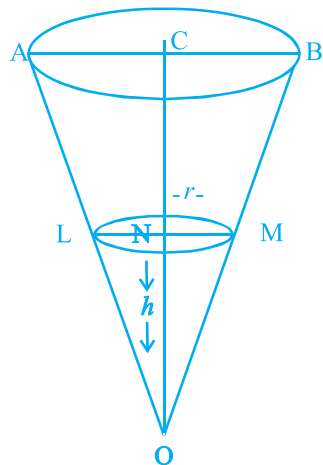

$$\Rightarrow \frac{MN}{CB} = \frac{ON}{OC} \text{ or } \frac{r}{5} = \frac{h}{10} \Rightarrow r = \frac{h}{2} \quad 1$$

$$\text{Now, } V = \frac{1}{3} r^2 h \quad \dots \text{ (i)}$$

Substituting $r = \frac{h}{2}$ in (i), we get

$$V = \frac{1}{12} \pi h^3 \quad 1 \frac{1}{2}$$

Differentiating w.r.t. t

$$\frac{dV}{dt} = \frac{3}{12} h^2 \frac{dh}{dt}$$

$$\Rightarrow \frac{dh}{dt} = \frac{4}{\pi h^2} \frac{dv}{dt}$$

$$\text{Therefore, when } h = 6 \text{ cm, } \frac{dh}{dt} = \frac{4}{9\pi} \text{ cm/minute} \quad 1 \frac{1}{2}$$

OR

$$f(x) = x^3 + \frac{1}{x^3}$$

$$\Rightarrow f'(x) = 3x^2 - \frac{3}{x^4}$$

$$= \frac{3(x^6 - 1)}{x^4} = \frac{3(x^2 - 1)(x^4 + x^2 + 1)}{x^4} \quad 1$$

As $x^4 + x^2 + 1 > 0$ and $x^4 > 0$, therefore, for f to be increasing, we have

$$x^2 - 1 > 0$$

$$\Rightarrow x < -1, -1 < x < 1,$$

$$\frac{1}{2}$$

Thus f is increasing in $(-\infty, -1) \cup (1, \infty)$

(ii) For f to be decreasing $f'(x) < 0$

$$\Rightarrow x^2 - 1 < 0$$

$$\Rightarrow (x - 1)(x + 1) < 0 \Rightarrow x \in (-1, 0) \cup (0, 1) \quad [x \neq 0 \text{ as } f \text{ is not defined at } x = 0]$$

$$\frac{1}{2}$$

Thus $f(x)$ is decreasing in $(-1, 0) \cup (0, 1)$

16. Let $\frac{3x-2}{x^3 - x - 1^2} = \frac{A}{x-3} + \frac{B}{x-1} + \frac{C}{x-1^2}$

1

Then $3x - 2 = A(x + 1)^2 + B(x + 1)(x + 3) + C(x + 3)$

comparing the coefficient of x^2 , x and constant, we get

$$A + B = 0, 2A + 4B + C = 3 \text{ and } A + 3B + 3C = -2$$

Solving these equations, we get

$$A = \frac{-11}{4}, B = \frac{11}{4} \text{ and } C = \frac{-5}{2}$$

$$\frac{1}{2}$$

$$\Rightarrow \frac{3x-2}{x^3 - x - 1^2} = \frac{-11}{4x-3} + \frac{11}{4x-1} - \frac{5}{2x-1^2}$$

$$\text{Hence } \int \frac{3x-2}{(x+3)(x+1)^2} dx = \frac{-11}{4} \int \frac{1}{x+3} dx + \frac{11}{4} \int \frac{1}{x+1} dx - \frac{5}{2} \int \frac{1}{(x+1)^2} dx$$

$$\frac{-11}{4} \log|x-3| + \frac{11}{4} \log|x+1| - \frac{5}{2x+1} + C_1 \quad \frac{1}{2}$$

OR

$$\log \log x - \frac{1}{\log x^2} dx$$

$$= \int \log(\log x) dx + \int \frac{1}{(\log x)^2} dx$$

Integrating $\log(\log x)$ by parts, we get

$$\log \log x dx = x \log \log x - \frac{x}{\log x} - \frac{1}{x} dx$$

$$x \log \log x - \frac{1}{\log x} dx \quad \frac{1}{2}$$

$$x \log \log x - \frac{x}{\log x} - x \frac{-1}{\log x^2} - \frac{1}{x} dx \quad 1$$

$$x \log \log x - \frac{x}{\log x} - \frac{1}{\log x^2} dx$$

Therefore, $\int \left(\log(\log x) + \frac{1}{(\log x)^2} \right) dx = x \log(\log x) - \frac{x}{\log x} + C$ $1 \frac{1}{2}$

17. Let $I = \int_0^1 \frac{x \sin x}{\cos^2 x} dx$

$$= \int_0^\pi \frac{(\pi-x) \sin(\pi-x)}{1+\cos^2(\pi-x)} dx \quad \left[\text{since } \int_0^a (x) dx = \int_0^a f(a-x) dx \right]$$

$$\int_0^1 \frac{\sin x}{\cos^2 x} dx - I \tag{1}$$

$$2I = \int_0^1 \frac{\sin x}{\cos^2 x} dx$$

Put $\cos x = t$ for $x = 0, t = 1, x = \pi/2, t = 0$ and $-\sin x dx = dt$.

Therefore $2I = \int_1^0 \frac{-dt}{1-t^2} = \int_{-1}^1 \frac{dt}{1-t^2}$ $1 \frac{1}{2}$

$$= \pi \left[\tan^{-1} t \right]_{-1}^1 = \pi \left[\tan^{-1}(+1) - \tan^{-1}(-1) \right]$$

$$= +\pi \left[\frac{\pi}{2} \right] = \frac{\pi^2}{2}$$
 $1 \frac{1}{2}$

$$I = \frac{\pi^2}{4}$$

18. The equation of circles which pass through the origin and whose centre lies on $x - axis$ is

$$(x-a)^2 + y^2 = a^2 \quad \dots (i) \quad 1\frac{1}{2}$$

Differentiating *w.r.t.x*, we get

$$2(x-a) + 2y \frac{dy}{dx} = 0$$

$$x - y \frac{dy}{dx} = a \quad 1\frac{1}{2}$$

Substituting the value of a in (i), we get

$$y \frac{dy}{dx} = y^2 - x \left(y \frac{dy}{dx} \right)^2$$

$$x^2 - y^2 - 2xy \frac{dy}{dx} = 0 \quad 1$$

19. The given differential equation is

$$x^2 y dx - x^3 - y^3 dy = 0$$

$$\Rightarrow \frac{dy}{dx} = \frac{x^2 y}{x^3 + y^3} \quad \dots(1)$$

Put $y = vx$ so that $\frac{dy}{dx} = v + x \frac{dv}{dx}$ 1

$$v + x \frac{dv}{dx} = \frac{vx^3}{x^3 + v^3 x^3}$$

$$v = x \frac{dv}{dx} \frac{v}{1 - v^3}$$

$$x \frac{dv}{dx} = \frac{-v^4}{1 - v^3}$$

$$\frac{1 - v^3}{v^4} dv = - \frac{dx}{x} \quad 1$$

$$\frac{1}{v^4} dv = \frac{1}{v} dv - \frac{dx}{x} \quad 1$$

$$\frac{-1}{3v^3} \log|v| - \log|x| = c$$

$$\Rightarrow \frac{-x^3}{3y^3} + \log|y| = c, \text{ which is the reqd. solution.} \quad 1$$

20. We have

$$\vec{a} \cdot \vec{b} = \vec{a} \cdot \vec{c}$$

$$\vec{a} \cdot \vec{b} - \vec{a} \cdot \vec{c} = \vec{0}$$

$$\vec{a} \cdot (\vec{b} - \vec{c}) = \vec{0} \quad 1$$

$$\vec{a} \cdot \vec{0} \text{ or } \vec{b} - \vec{c} = \vec{0} \text{ or } \vec{a} \parallel \vec{b} - \vec{c} \quad 1$$

$$\Rightarrow \vec{a} \parallel (\vec{b} - \vec{c}) \quad [\text{since } \vec{a} \neq \vec{0} \text{ \& } \vec{b} \neq \vec{c}] \quad 1$$

$$\vec{b} - \vec{c} = \lambda \vec{a}, \text{ for some scalar}$$

$$\Rightarrow \vec{b} = \vec{c} + \lambda \vec{a} \quad 1$$

21. We know that the shorest distance between the lines $\vec{r} = \vec{a} + \vec{b}t$ and $\vec{r} = \vec{c} + \vec{d}s$ is given by

$$D = \frac{|(\vec{c} - \vec{a}) \cdot \vec{b} \times \vec{d}|}{|\vec{b} \times \vec{d}|}$$

Now given equations can be written as

$$\vec{r} = -\hat{i} + \hat{j} - \hat{k} + t(\hat{i} + \hat{j} - \hat{k}) \quad \text{and} \quad \vec{r} = \hat{i} - \hat{j} + 2\hat{k} + s(-\hat{i} + 2\hat{j} + \hat{k})$$

Therefore $\vec{c} - \vec{a} = 2\hat{i} + 2\hat{j} + 3\hat{k}$ $\frac{1}{2}$

and $\vec{b} \times \vec{d} = \begin{vmatrix} \hat{i} & \hat{j} & \hat{k} \\ 1 & 1 & -1 \\ -1 & 2 & 1 \end{vmatrix} = 3\hat{i} - 0\hat{j} + 3\hat{k}$

$|\vec{b} \times \vec{d}| = \sqrt{9 + 9 + 18} = 3\sqrt{2}$ $\frac{1}{2}$

Hence $D = \frac{|(\vec{c} - \vec{a}) \cdot \vec{b} \times \vec{d}|}{|\vec{b} \times \vec{d}|} = \frac{|6 - 0 + 9|}{3\sqrt{2}} = \frac{15}{3\sqrt{2}} = \frac{5}{\sqrt{2}} = \frac{5\sqrt{2}}{2}$ 2

22. Let E_1, E_2, E_3, E_4 and A be the events defined as follows :

E_1 = the missing card is a heart card,

E_2 = the missing card is a spade card,

E_3 = the missing card is a club card,

E_4 = the missing card is a diamond card $\frac{1}{2}$

A = Drawing two heart cards from the remaining cards.

Then $P(E_1) = \frac{13}{52} \cdot \frac{1}{4}$, $P(E_2) = \frac{13}{52} \cdot \frac{1}{4}$, $P(E_3) = \frac{13}{52} \cdot \frac{1}{4}$, $P(E_4) = \frac{13}{52} \cdot \frac{1}{4}$ $\frac{1}{2}$

$P(A/E_1)$ = Probability of drawing two heart cards given that one heart card is missing = $\frac{{}^{12}C_2}{{}^{51}C_2}$

$P(A/E_2)$ = Probability of drawing two heart cards given that one spade card is missing = $\frac{{}^{13}C_2}{{}^{51}C_2}$

Similarly, we have $P(A/E_3) = \frac{{}^{13}C_2}{{}^{51}C_2}$ and $P(A/E_4) = \frac{{}^{13}C_2}{{}^{51}C_2}$ 1

By Baye's thereon, we have the

required Probability = $P(E_1/A)$

$$= \frac{P(E_1) \cdot P(A/E_1)}{P(E_1) \cdot P(A/E_1) + P(E_2) \cdot P(A/E_2) + P(E_3) \cdot P(A/E_3) + P(E_4) \cdot P(A/E_4)} \quad 1$$

$$\frac{\frac{1}{4} \cdot \frac{{}^{12}C_2}{{}^{51}C_2}}{\frac{1}{4} \cdot \frac{{}^{12}C_2}{{}^{51}C_2} + \frac{1}{4} \cdot \frac{{}^{13}C_2}{{}^{51}C_2} + \frac{1}{4} \cdot \frac{{}^{13}C_2}{{}^{51}C_2} + \frac{1}{4} \cdot \frac{{}^{13}C_2}{{}^{51}C_2}} \quad 1$$

$$\frac{{}^{12}C_2}{{}^{12}C_2 + {}^{13}C_2 + {}^{13}C_2 + {}^{13}C_2} = \frac{66}{66 + 78 + 78 + 78} = \frac{11}{50}$$

Section C

23. We have

$$AB = \begin{pmatrix} 1 & -1 & 0 & 2 & 2 & -4 \\ 2 & 3 & 4 & -4 & 2 & -4 \\ 0 & 1 & 2 & 2 & -1 & 5 \end{pmatrix} \quad 1$$

$$= \begin{pmatrix} 6 & 0 & 0 & 1 & 0 & 0 \\ 0 & 6 & 0 & 6 & 0 & 1 & 0 \\ 0 & 0 & 6 & 0 & 0 & 1 \end{pmatrix} = 6I$$

Similarly $BA = 6I$, Hence $AB = 6I = BA$

As $AB = 6I$, $A^{-1}AB = 6A^{-1}I$. This gives 1

$$IB = 6A^{-1}, \text{ i.e., } A^{-1} = \frac{1}{6}B = \frac{1}{6} \begin{pmatrix} 2 & 2 & -4 \\ -4 & 2 & -4 \\ 2 & -1 & 5 \end{pmatrix} \quad 1\frac{1}{2}$$

The given system of equations can be written as

$AX = C$, where

$$X = \begin{pmatrix} x \\ y \\ z \end{pmatrix}, C = \begin{pmatrix} 3 \\ 17 \\ 7 \end{pmatrix}$$

The solution of the given system $AX = C$ is given by $X = A^{-1}C$ $\frac{1}{2}$

$$\begin{array}{rcccc} x & & 2 & 2 & -4 & 3 \\ y & \frac{1}{6} & -4 & 2 & -4 & 17 \\ z & & 2 & -1 & 5 & 7 \end{array}$$

$$\frac{1}{6} \begin{array}{rcccc} & 6 & 34 & 28 & 2 \\ -12 & 34 & -28 & & -1 \\ & 6 & -17 & 34 & 4 \end{array}$$

Hence $x = 2$, $y = 1$ and $z = 4$ 2

- 24. Commutative:** For any $a, b \in \mathbf{R} - \{-1\}$, we have $a * b = a + b + ab$ and $b * a = b + a + ba$. But {by commutative property of addition and multiplication on $\mathbf{R} - \{-1\}$, we have:

$$a + b + ab = b + a + ba .$$

$$a * b = b * a$$

Hence $*$ is commutative on $\mathbf{R} - \{-1\}$ 2

Identity Element : Let e be the identity element.

Then $a * e = e * a$ for all $a \in \mathbf{R} - \{-1\}$

$$a + e + ae = a \text{ and } e + a + ea = a$$

$$e(1+a) = 0 \quad e = 0 \text{ [since } a \neq -1]$$

Thus, 0 is the identity element for $*$ defined on $\mathbf{R} - \{-1\}$ 2

Inverse : Let $a \in \mathbf{R} - \{-1\}$ and let b be the inverse of a . Then

$$a * b = e = b * a$$

$$a * b = 0 = b * a \quad (\because e = 0)$$

$$a + b + ab = 0$$

$$\Rightarrow b = \frac{-a}{a+1} \in \mathbf{R} \text{ (since } a \neq -1) \tag{2}$$

Moreover, $\frac{-a}{a-1} \neq 1$. Thus $b = \frac{a}{a-1} \in \mathbf{R} - \{-1\}$.

Hence, every element of $\mathbf{R} - \{-1\}$ is invertible and the inverse of an element a is $\frac{-a}{a-1}$.

- 25.** Let H be the hypotenuse AC and θ be the angle between the hypotenuse and the base BC of the right angled triangle ABC .

Then $BC = \text{base} = H \cos \theta$ and $AC = \text{Perpendicular} = H \sin \theta$

$$\begin{aligned} P &= \text{Perimeter of right-angled triangle} \\ &= H + H \cos \theta + H \sin \theta = P \end{aligned} \tag{1}$$

For maximum or minimum of perimeter, $\frac{dP}{d\theta} = 0$

$$H(0 - \sin \theta + \cos \theta) = 0, \text{ i.e. } \theta = \frac{\pi}{4} \tag{1}$$

Now

$$\frac{d^2P}{d\theta^2} = -H \cos \theta - H \sin \theta \tag{1}$$

$$\Rightarrow \frac{d^2P}{d\theta^2} \text{ at } \theta = \frac{\pi}{4} = -H \left[\frac{1}{\sqrt{2}} - \frac{1}{\sqrt{2}} \right] = -\sqrt{2}H < 0 \tag{1}$$

Thus P is maximum at $\theta = \frac{\pi}{4}$.

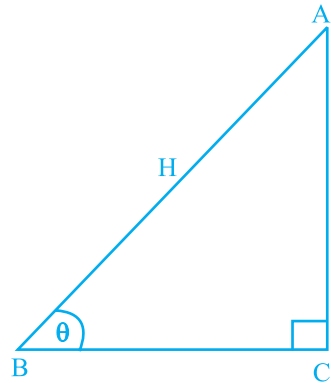
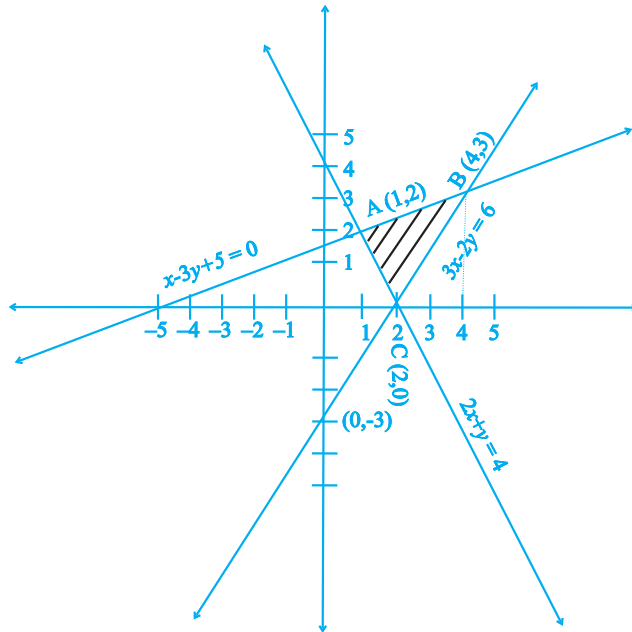

Fig. 1.2

For $\theta = \frac{\pi}{4}$, Base = $H \cos\left(\frac{\pi}{4}\right) = \frac{H}{\sqrt{2}}$ and Perpendicular = $\frac{H}{\sqrt{2}}$ 1

Hence, the perimeter of a right-angled triangle is maximum when the triangle is isosceles. $\frac{1}{2}$

26.



$\frac{1}{2}$

$$\begin{aligned} x - 3y + 5 &= 0 \\ x - 5, x &= 0 \\ y &= 0, y = \frac{5}{3} \end{aligned} \quad 16$$

Fig. 1.3

Finding the point of intersection of given lines as A(1,2), B(4,3) and C (2,0) 1

Therefore, required Area

$$\int_1^4 \frac{x-5}{3} dx - \int_1^2 4-2x dx - \int_2^4 \frac{3x-6}{2} dx$$

$$= \frac{1}{3} \left[\left(\frac{x^2}{2} + 5x \right) \right]_1^4 - \left[(4x - x^2) \right]_1^2 - \left[\left(\frac{3}{4}x^2 - 3x \right) \right]_2^4 \quad 2\frac{1}{2}$$

$$\frac{1}{3} \left[\frac{16}{2} + 20 \right] - \left[8 - 4 \right] - \left[\frac{3}{4} \cdot 16 - 12 \right] + \left[\frac{3}{4} \cdot 4 - 6 \right]$$

$$= \frac{1}{3} \times \frac{45}{2} - 1 - 3 = \frac{7}{2} \text{ sq. units} \quad 1$$

OR

$$I = \int_1^4 2x^2 - x \, dx - \int_1^2 (4x - x^2) \, dx - \int_2^4 \left(\frac{3}{4}x^2 - 3x \right) \, dx$$

$$\lim_{h \rightarrow 0} \left[f(1) + f(1+h) + f(1+2h) + \dots + f(1+(n-1)h) \right] h \quad (i) \quad 1$$

where $h = \frac{4-1}{n}$, i.e., $nh = 3$

Now, $f(1) = \overline{2x^2 - x} = 2(1)^2 - 1 = 1$

$$f(1+h) = 2(1+h)^2 - (1+h) = 2(1 + 2h + h^2) - 1 - h = 2 + 4h + 2h^2 - 1 - h = 1 + 3h + 2h^2$$

Therefore, $f(1) = 1$, $f(1+h) = 1 + 3h + 2h^2$, $f(1+2h) = 1 + 6h + 8h^2$, $f(1+3h) = 1 + 9h + 18h^2$

$$f(1+2h) = 1 + 6h + 8h^2, \quad f(1+(n-1)h) = 1 + 3(n-1)h + 2(n-1)^2h^2 \quad 1\frac{1}{2}$$

Thus, I $\lim_{h \rightarrow 0} h n^2 \frac{n(n-1)(2n-1)}{6} h^2 = \frac{3n(n-1)(nh-h)}{2}$

$$\lim_{h \rightarrow 0} h n^2 \frac{2nh(nh-h)(2nh-h)}{6} = \frac{3nh(nh-h)}{2} \quad 2$$

$$\lim_{h \rightarrow 0} 3 \frac{2 \cdot 3 \cdot (3-h)(6-h)}{6} = \frac{3 \cdot 3 \cdot (3-n)}{2} = \frac{69}{2} \quad 1\frac{1}{2}$$

27.

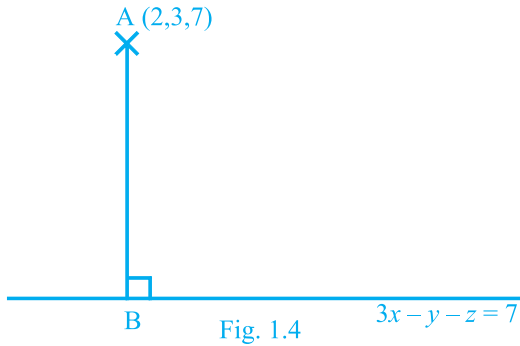

The equation of line AB perpendicular to the given plane is

$$\frac{x-2}{3} = \frac{y-3}{-1} = \frac{z-7}{-1} = \lambda \text{ (say)} \quad 1\frac{1}{2}$$

Therefore coordinates of the foot B of perpendicular drawn from A on the plane $3x - y - z = 7$ will be

$$3 \quad 2, - \quad 3, \quad 7 \quad 1\frac{1}{2}$$

Since B $3 \quad 2, - \quad 3, \quad 7$ lies on $3x - y - z = 7$, we have

$$3 \cdot 3 - 2 - - \quad 3 - - \quad 7 \quad 7 \quad 1$$

Thus B = (5, 2, 6) and distance AB = (length of perpendicular) is 2

$$\sqrt{2-5^2 + 3-2^2 + 7-6^2} = \sqrt{11} \text{ units}$$

Hence the co-ordinates of the foot of perpendicular is (5, 2, 6) and the length of perpendicular = $\sqrt{11}$ 1

OR

The given lines are

$$\vec{r} = \hat{i} + \hat{j} + \hat{k} + \lambda(\hat{i} + 2\hat{j} - \hat{k}) \text{ ----- (i)}$$

$$\text{and } \vec{r} = \hat{i} + \hat{j} - \hat{k} + \mu(\hat{i} + \hat{j} - 2\hat{k}) \text{ -----(ii)}$$

Note that line (i) passes through the point (1, 1, 0) $\frac{1}{2}$

and has d.r.s, 1, 2, -1, and line (ii) passes through the point (1, 1, 0) $\frac{1}{2}$

and has d.r.s, -1, 1, -2

Since the required plane contain the lines (i) and (ii), the plane is parallel to the vectors

$$\vec{b} = \hat{i} + 2\hat{j} + \hat{k} \text{ and } \vec{c} = \hat{i} + \hat{j} + 2\hat{k}$$

Therefore required plane is perpendicular to the vector $\vec{b} \times \vec{c}$ and 1

$$\vec{b} \times \vec{c} = \begin{vmatrix} \hat{i} & \hat{j} & \hat{k} \\ 1 & 2 & 1 \\ 1 & 1 & 2 \end{vmatrix} = -3\hat{i} + 3\hat{j} + 3\hat{k} \quad 1$$

Hence equation of required plane is

$$\vec{r} - \vec{a} \cdot \vec{b} \times \vec{c} = 0 \quad 1$$

$$\vec{r} - \hat{i} \cdot \hat{j} \cdot \vec{3i} \times \vec{3j} \times \vec{3k} = 0$$

$$\vec{r} \cdot \vec{-i} \cdot \vec{j} \cdot \vec{k} = 0$$

and its cartesian form is $-x + y + z = 0$ 2

Distance from (1, 1, 1) to the plane is

$$\frac{|1(-1) + 1.1 + 1.1|}{\sqrt{1^2 + 1^2 + 1^2}} = \frac{1}{\sqrt{3}} \text{unit}$$

- 28.** Let x denote the number of kings in a draw of two cards. Note that x is a random variable which can take the values 0, 1, 2. Now

$$P(x=0) = P(\text{no king}) = \frac{{}^{48}C_2}{{}^{52}C_2} = \frac{48!}{2!(48-2)!} \cdot \frac{48 \times 47}{52 \times 51} = \frac{188}{221} \quad 1$$

$P(x=1) = P(\text{one king and one non-king})$

$$\frac{{}^4C_1 \cdot {}^{48}C_1}{{}^{52}C_2} = \frac{4 \cdot 48 \cdot 2}{52 \cdot 51} = \frac{32}{221} \quad 1$$

$$\text{and } P(x=2) = P(\text{two kings}) = \frac{{}^4C_2}{{}^{52}C_2} = \frac{4 \times 3}{52 \times 51} = \frac{1}{221} \quad 1$$

Thus, the probability distribution of x is

x	0	1	2
P_x	$\frac{188}{221}$	$\frac{32}{221}$	$\frac{1}{221}$

1

Now mean of $x = E(x) = \sum_{i=1}^n x_i P(x_i)$

$$= 0 \times \frac{188}{221} + 1 \times \frac{32}{221} + \frac{2 \times 1}{221} = \frac{34}{221}$$

Also $E(x^2) = \sum_{i=1}^n x_i^2 p_{x_i}$

$$= 0^2 \frac{188}{221} + 1^2 \frac{32}{221} + 2^2 \frac{1}{221} = \frac{36}{221}$$

Now $\text{var}(x) = E(x^2) - [E(x)]^2 = \frac{36}{221} - \left(\frac{34}{221}\right)^2 = \frac{6800}{221^2}$

1

Therefore standard deviation $\sqrt{\text{var}(x)}$

$$= \frac{\sqrt{6800}}{221} \approx 0.37$$

1

29. Let the mixture contains x kg of food I and y kg of food II.

Thus we have to minimise

$$Z = 50x + 70y$$

Subject to

$$2x + y \geq 8$$

$$x + 2y \geq 10$$

$$x, y \geq 0$$

2

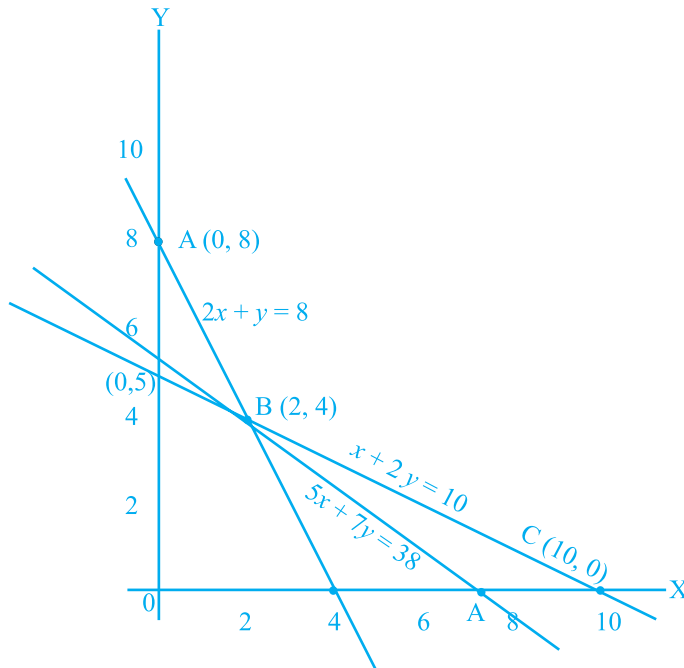

$2\frac{1}{2}$

The feasible region determined by the above inequalities is an unbounded region. Vertices of feasible region are

A (0, 8) B (2, 4) C(10, 0)

$\frac{1}{2}$

Now value of Z at A (0, 8) = $50 \times 0 + 70 \times 8 = 560$

B(2, 4) = 380 C(10, 0) = 500

As the feasible region is unbounded therefore, we have to draw the graph of

$50x + 70y < 380$ i.e. $5x + 7y < 38$

$\frac{1}{2}$

As the resulting open half plane has no common point with feasible region thus the minimum value of $z = 380$ at B (2, 4). Hence, the optimal mixing strategy for the dietician would be to mix 2 kg of food I and 4 kg of food II to get the minimum cost of the mixture i.e Rs 380.

1

ANSWERS

1.3 EXERCISE

1. $(b,b), (c,c), (a,c)$
2. $[-5,5]$
3. $4x^2 - 4x - 1$
4. $f^{-1} x = \frac{x-3}{2}$
5. $f^{-1}\{(b,a), (d,b), (a,c), (c,d)\}$
6. $f \circ f \circ x = x^4 - 6x^3 - 10x^2 - 3x$
7. $2, -1$
8. (i) represents function which is surjective but not injective
(ii) does not represent function.
9. $f \circ g = 2, 5, 5, 2, 1, 5$
12. (i) f is not function (ii) g is function (iii) h is function (iv) k is not function
14. $\frac{1}{3}, 1$
17. Domain of $R = \{1, 2, 3, 4, \dots, 20\}$ and
Range of $R = \{1, 3, 5, 7, 9, \dots, 39\}$. R is neither reflexive, nor symmetric and nor transitive.
21. (i) f is one-one but not onto, (ii) g is neither one-one nor onto (iii) h is bijective, (iv) k is neither one-one nor onto.
22. (i) transitive (ii) symmetric (iii) reflexive, symmetric and transitive (iv) transitive.
23. $[(2,5)] = \{(1,4), (2,5), (3,6), (4,7), (5,8), (6,9)\}$

25. (i) $f \circ g \ x \ 4x^2 - 6x - 1$

(ii) $g \circ f \ x \ 2x^2 - 6x - 1$

(iii) $f \circ f \ x \ x^4 - 6x^3 + 14x^2 - 15x + 5$

(iv) $g \circ g \ x \ 4x - 9$

26. (ii) & (iv)

27. (i) 28. C 29. B 30. D

31. B 32. B 33. A 34. C

35. C 36. B 37. D 38. A

39. B 40. B 41. A 42. A

43. C 44. B 45. D 46. A

47. B 48. R = {3, 8}, {6, 6}, (9, 4), (12, 2)

49. $R = \{(1, 1), (1, 2), (2, 1), (2, 2), (2, 3), (3, 2), (3, 3), (3, 4), (4, 3), (4, 4), (5, 5)\}$

50. $g \circ f = \{(1, 3), (3, 1), (4, 3)\}$ and $f \circ g = \{(2, 5), (5, 2), (1, 5)\}$

51. $f \circ f \circ f \ x \ \frac{x}{\sqrt{3x^2 - 1}}$ 52. $f^{-1}(x) = 7 + (4 - x)^{\frac{1}{3}}$

53. False 54. False 55. False 56. False

57. True 58. False 59. False 60. True

61. False 62. False

2.3 EXERCISE

1. 0

2. -1

4. $-\frac{\pi}{12}$

5. $-\frac{\pi}{3}$

7. 0, -1

8. $\frac{14}{15}$

11. $\frac{-3}{4}, \frac{3}{4}$

13. $\tan^{-1} \frac{4}{3} - x$ 17. $\frac{-}{4}$ 19. $\frac{a_n - a_1}{1 + a_1 a_n}$
20. C 21. D 22. B 23. D
24. A 25. A 26. B 27. C
28. A 29. B 30. A 31. D
32. D 33. B 34. A 35. C
36. A 37. A
38. $\frac{2\pi}{3}$ 39. $\frac{2\pi}{5}$ 40. $\sqrt{3}$ 41. ϕ
42. $\frac{\pi}{3}$ 43. $\frac{2\pi}{3}$ 44. 0 45. 1
46. $-2\pi, 2\pi$ 47. $xy > -1$ 48. $\pi - \cot^{-1} x$
49. False 50. False 51. True 52. True
53. True 54. False 55. True

3.3 EXERCISE

1. $28 \times 1, 1 \times 28, 4 \times 7, 7 \times 4, 14 \times 2, 2 \times 14$. If matrix has 13 elements then its order will be either 13×1 or 1×13 .
2. (i) 3×3 , (ii) 9, (iii) $a_{23} \quad x^2 - y, a_{31} \quad 0, a_{12} \quad 1$
3. (i) $\begin{pmatrix} 1 & 9 \\ 2 & 2 \\ 0 & 2 \end{pmatrix}$ (ii) $\begin{pmatrix} 1 & 4 \\ -1 & 2 \end{pmatrix}$
4. $e^x \sin x \quad e^x \sin 2x$ 5. $a = 2, b = 2$ 6. Not possible
- $e^{2x} \sin x \quad e^{2x} \sin 2x$
- $e^{3x} \sin x \quad e^{3x} \sin 2x$
7. (i) $X + Y = \begin{bmatrix} 5 & 2 & -2 \\ 12 & 0 & 1 \end{bmatrix}$ (ii) $2X - 3Y = \begin{bmatrix} 0 & -1 & 1 \\ -11 & -10 & -18 \end{bmatrix}$

$$(iii) Z = \begin{bmatrix} -5 & -2 & 2 \\ -12 & 0 & -1 \end{bmatrix}$$

$$8. \quad x = 4$$

$$11. \quad A^{-1} = \begin{bmatrix} -1 & -2 & -3 \\ 7 & 1 & 5 \end{bmatrix}$$

$$13. \quad A = [-1 \ 2 \ 1]$$

$$15. \quad AB = \begin{bmatrix} 12 & 9 \\ 12 & 15 \end{bmatrix}, BA = \begin{bmatrix} 9 & 6 & 12 \\ 7 & 8 & 16 \\ 4 & 5 & 10 \end{bmatrix}$$

$$19. \quad X = \begin{bmatrix} -2 & 0 \\ -1 & -3 \end{bmatrix}, Y = \begin{bmatrix} 2 & 1 \\ 2 & 2 \end{bmatrix}$$

$$24. \quad A = [-4]$$

$$37. \quad (i) \frac{1}{22} \begin{bmatrix} 7 & -3 \\ 5 & 1 \end{bmatrix} \quad (ii) \text{ not possible}$$

$$38. \quad x = 2, y = 4 \text{ or } x = 4, y = 2, z = -6, w = 4$$

$$39. \quad \begin{bmatrix} -24 & -10 \\ -28 & -38 \end{bmatrix}$$

$$41. \quad a = 2, b = 4, c = 1, d = 3$$

$$43. \quad \begin{bmatrix} 18 & 8 \\ 16 & 18 \end{bmatrix}$$

$$45. \quad a = -2, b = 0, c = -3$$

$$10. \quad -2, -14$$

$$12. \quad A = \begin{bmatrix} 1 & 1 \\ 1 & 0 \end{bmatrix}$$

$$18. \quad x = 1, y = 2$$

$$20. \quad \begin{bmatrix} k \\ 2k \end{bmatrix}, \begin{bmatrix} k & k \\ 2k & 2k \end{bmatrix} \text{ etc.}$$

where k is a real number

$$30. \quad \text{True when } AB = BA$$

$$40. \quad A^3 = \begin{bmatrix} 187 & -195 \\ -156 & 148 \end{bmatrix}$$

$$42. \quad \begin{bmatrix} 1 & -2 & -5 \\ 3 & 4 & 0 \end{bmatrix}$$

44. True for all real values of α

50. $x = \pm \frac{1}{\sqrt{2}}, y = \pm \frac{1}{\sqrt{6}}, z = \pm \frac{1}{\sqrt{3}}$

51. (i) $\begin{bmatrix} -7 & -9 & 10 \\ -12 & -15 & 17 \\ 1 & 1 & -1 \end{bmatrix}$ (ii) inverse does not exist (iii) $\begin{bmatrix} 3 & -1 & 1 \\ -15 & 6 & -5 \\ 5 & -2 & 2 \end{bmatrix}$

52. $\begin{bmatrix} 2 & 2 & \frac{5}{2} \\ 2 & -1 & \frac{3}{2} \\ \frac{5}{2} & \frac{3}{2} & 2 \end{bmatrix} + \begin{bmatrix} 0 & 1 & \frac{-3}{2} \\ -1 & 0 & \frac{1}{2} \\ \frac{3}{2} & \frac{-1}{2} & 0 \end{bmatrix}$

53. A

54. D

55. B

56. D

57. D

58. D

59. A

60. B

61. C

62. D

63. A

64. A

65. D

66. D

67. A

68. Null matrix

69. Skew symmetric matrix

70. -1

71. 0

72. Rectangular matrix

73. Distributive

74. Symmetric matrix

75. Symmetric matrix

76. (i) B A (ii) kA (iii) $k A - B$

77. Skew Symmetric matrix

78. (i) Skew symmetric matrix

(ii) neither symmetric nor skew symmetric matrix

79. Symmetric matrix

80. $AB = BA$

81. does not exist

82. False

83. False

84. False

85. True

86. True

87. False

88. False

89. True

90. False

91. False

92. False

93. False

94. True

95. False

96. True

97. False

98. True

99. False

100. True

101. True

4.3 EXERCISE

1. $x^3 - x^2 + 2$ 2. $a^2(a + x + y + z)$ 3. $2x^3y^3z^3$
 4. $3(x + y + z)(xy + yz + zx)$ 5. $16(3x + 4)$ 6. $(a + b + c)^3$
12. $\theta = n\pi$ or $n\pi + (-1)^n \left(\frac{\pi}{6}\right)$ 13. $x = 0, -12$ 18. $x = 0, y = -5, z = -3$
19. $x = 1, y = 1, z = 1$ 20. $x = 2, y = -1, z = 4$
24. C 25. C 26. B 27. D
 28. C 29. A 30. A 31. A
 32. C 33. D 34. D 35. D
36. B 37. C 38. $27|A|$ 39. $\frac{1}{|A|}$
40. Zero 41. $\frac{1}{2}$ 42. $(A^{-1})^2$ 43. 9
44. Value of the determinant 45. $x = 2, y = 7$
46. $(y - z)(z - x)(y - x + xyz)$ 47. Zero 48. True
 49. False 50. False 51. True 52. True
 53. True 54. False 55. True 56. True
 57. True 58. True

5.3 EXERCISE

1. Continuous at $x = 1$ 2. Discontinuous 3. Discontinuous 4. Continuous
 5. Discontinuous 6. Continuous 7. Continuous 8. Discontinuous
9. Continuous 10. Continuous 11. $k = \frac{7}{2}$ 12. $k = \frac{1}{2}$
13. $k = -1$ 14. $k = \pm 1$ 16. $a = 1, b = -1$
17. Discontinuous at $x = -2$ and $x = \frac{-5}{2}$ 18. Discontinuous at $x = 1, \frac{1}{2}$ and 2
 20. Not differentiable at $x = 2$ 21. Differentiable at $x = 0$
 22. Not differentiable at $x = 2$ 25. $-(\log 2) \cdot \sin 2x \cdot 2^{\cos^2 x}$

26. $\frac{8^x}{x^8} \left[\log 8 - \frac{8}{x} \right]$ 27. $\frac{1}{\sqrt{x^2 - a}}$ 28. $\frac{5}{x \log x^5 \log \log x^5}$
29. $\frac{\cos \sqrt{x}}{2\sqrt{x}} - \frac{\sin 2\sqrt{x}}{2\sqrt{x}}$ 30. $n 2ax - b \sin^{n-1} ax^2 - bx - c \cos ax^2 - bx - c$
31. $\frac{-1}{2\sqrt{x-1}} \sin \tan \sqrt{x-1} \sec^2 \sqrt{x-1}$
32. $2x \cos x^2 - 2x \sin 2x^2 - \sin 2x$ 33. $\frac{-1}{2\sqrt{x} x - 1}$
34. $\sin x \cos x \frac{\cos^2 x}{\sin x} - \sin x \cdot \log \sin x$ 35. $\sin^{mx} x \cos^n x (-n \tan x + m \cot x)$
36. $x - 1 - x^2 + x^3 - 9x^2 - 34x - 29$
37. -1 38. $\frac{1}{2}$ 39. $\frac{1}{2}$ 40. -1
41. $\frac{-3}{\sqrt{1-x^2}}$ 42. $\frac{3a}{a^2 - x^2}$ 43. $\frac{-x}{\sqrt{1-x^4}}$ 44. $\frac{t^2 - 1}{t^2 - 1}$
45. $e^{-2\theta} \left(\frac{-\theta^3 + \theta^2 + \theta + 1}{\theta^3 + \theta^2 + \theta - 1} \right)$ 46. $\cot \theta$ 47. 1
48. t 51. $-\frac{1}{\sqrt{3}}$ 52. $\frac{\tan x - x}{\sin^2 x}$ 53. $\frac{1}{2}$
54. $\frac{2xy^2 - y^3 \cos xy - y}{xy^2 \cos xy - x - y^2}$ 55. $\frac{y \sec x - y \tan x - y}{\sec x - y \tan x - y - x}$
56. $\frac{-x}{y}$ 57. $\frac{y - 4x^3 - 4xy^2}{4yx^2 + 4y^3 - x}$ 64. $-2 \sin y \cos^3 y$
70. Not applicable since f is not differentiable at $x = 1$

71. $\dots, -2$ 72. $(2, -4)$ 77. $\frac{7}{2}, \frac{1}{4}$ 78. $\frac{3}{2}, 0$
79. $p = 3, q = 5$ 82. $x^{\tan x} \left(\sec^2 x \log x + \frac{\tan x}{x} \right) + \frac{x}{\sqrt{2}\sqrt{x^2+1}}$ 83. D
84. C 85. B 86. A 87. A
88. A 89. C 90. B 91. B
92. A 93. A 94. B 95. A
96. B 97. $|x| |x-1|$ 98. $\frac{2}{3x}$ 99. $\frac{-1}{\sqrt{2}}$
100. $\left(\frac{\sqrt{3}+1}{2} \right)$ 101. -1 102. False 103. True
104. True 105. True 106. False

6.3 EXERCISE

3. 8 m/s 4. $(\sqrt{2-\sqrt{2}})^v$ unit/sec. 5. $\theta = \frac{\pi}{3}$ 6. 31.92
7. $0.018\pi \text{cm}^3$ 8. $2\frac{2}{3}$ m/s towards light, -1 m/s
9. 2000 litres/s, 3000 litre/s 11. $2x^3 - 3x + 1$
12. $k^2 = 8$ 14. $(4, 4)$ 15. $\tan^{-1}\left(\frac{4\sqrt{2}}{7}\right)$ 17. $x + 3y = \pm 8$
18. $(3, 2), (-1, 2)$ 23. $(1, -16)$, max. slope = 12
26. $x = 1$ is the point of local maxima; local maximum = 0
 $x = 3$ is the point of local minima; local minimum = -28
 $x = 0$ is the point of inflection.
27. Rs 100 30. 6cm, 12 cm, 864 cm^3

31. 1:1 33. Rs 1920 34. $\frac{2}{3}x^3\left(1+\frac{2\pi}{27}\right)$
35. C 36. B 37. A 38. C
39. D 40. A 41. A 42. D
43. B 44. B 45. C 46. B
47. D 48. A 49. B 50. C
51. A 52. C 53. B 54. C
55. B 56. A 57. B 58. B
59. C 60. (3, 34) 61. $x + y = 0$ 62. $- , -1$
63. (1,) 64. $2\sqrt{ab}$

7.3 EXERCISE

3. $\frac{x^2}{2} - x + 3\log|x+1| + c$ 4. $\frac{x^3}{3} + c$ 5. $\log|x - \sin x| + c$
6. $\tan\frac{x}{2} + C$ 7. $\frac{\tan^5 x}{5} - \frac{\tan^3 x}{3} + c$ 8. $x + c$
9. $-2\cos\frac{x}{2} - 2\sin\frac{x}{2} + c$ 10. $2\left[\frac{x\sqrt{x}}{3} - \frac{x}{2} + \sqrt{x} - \log|\sqrt{x}+1|\right] + c$
11. $-a\left[\cos^{-1}\left(\frac{x}{a}\right) + \sqrt{1-\frac{x^2}{a^2}}\right] + c$ 12. $\frac{4}{3}\left[x^{3/4} - \log\left|1+x^4\right|\right] + c$
13. $\frac{-1}{3}\left(1+\frac{1}{x^2}\right)^{\frac{3}{2}} + c$ 14. $\frac{1}{3}\sin^{-1}\frac{3x}{4} + c$
15. $\frac{1}{\sqrt{2}}\sin^{-1}\frac{4t-3}{3} + c$
16. $3\sqrt{x^2-9} - \log|x - \sqrt{x^2-9}| + c$

$$17. \frac{x-1}{2} \sqrt{5-2x+x^2} + 2 \log \left| x-1 + \sqrt{5-2x+x^2} \right| + c$$

$$18. \frac{1}{4} \log |x^2 - 1| - \log |x^2 - 1| + c$$

$$19. \frac{1}{4} \left\{ \log \left| \frac{1+x}{1-x} \right| \right\} - \frac{1}{2} \tan^{-1} x + c$$

$$20. \frac{x-a}{2} \sqrt{2ax-x^2} + \frac{a^2}{2} \sin^{-1} \left(\frac{x-a}{a} \right) + c$$

$$21. \frac{x \sin^{-1} x}{\sqrt{1-x^2}} + \log \left| \sqrt{1-x^2} \right|$$

$$22. -\frac{1}{2} \sin 2x - \sin x + c$$

$$23. \tan x - \cot x - 3x + c$$

$$24. \frac{2}{3} \sin^{-1} \sqrt{\frac{x^3}{a^3}} + c$$

$$25. 2 \sin x + x + c$$

$$26. \frac{1}{2} \sec^{-1}(x^2) + c$$

$$27. \frac{26}{3}$$

$$28. e^2 - 1$$

$$29. \tan^{-1} e - \frac{1}{4}$$

$$30. \frac{\log m}{m^2 - 1}$$

$$31. \pi$$

$$32. \sqrt{2} - 1$$

$$33. \frac{1}{3}$$

$$34. \frac{\sqrt{2}}{2} \tan^{-1} \frac{\sqrt{2}}{3}$$

$$35. \frac{1}{7} \log \left| \frac{x-2}{x+2} \right| + \frac{\sqrt{3}}{7} \tan^{-1} \frac{x}{\sqrt{3}} + c$$

$$36. \frac{1}{a^2 - b^2} \left[a \tan^{-1} \frac{x}{a} - b \tan^{-1} \frac{x}{b} \right] + c$$

$$37. \pi$$

$$38. \log \left| \frac{\sqrt{x-3}}{x-1} \cdot \frac{1}{6} \cdot \frac{1}{x} \cdot \frac{1}{2} \cdot \frac{1}{3} \right| + c$$

$$39. x e^{\tan^{-1} x} + c$$

$$40. a \left[\frac{x}{a} \tan^{-1} \sqrt{\frac{x}{a}} - \sqrt{\frac{x}{a}} + \tan^{-1} \sqrt{\frac{x}{a}} \right] + c$$

$$41. \frac{3}{2}$$

$$42. \frac{e^{-3x}}{24} [\sin 3x - \cos 3x] + \frac{3e^{-3x}}{40} [\sin x - 3\cos x] + c$$

$$43. \frac{1}{\sqrt{2}} \tan^{-1} \left(\frac{\tan x - 1}{\sqrt{2} \tan x} \right) + \frac{1}{2\sqrt{2}} \log \left| \frac{\tan x - \sqrt{2} \tan x + 1}{\tan x + \sqrt{2} \tan x + 1} \right| + c$$

$$44. \frac{\pi}{4} \left(\frac{a^2 + b^2}{a^3 b^3} \right)$$

$$45. \frac{3}{8} \log 3$$

$$46. \frac{\pi^2}{2} \log \frac{1}{2}$$

$$47. \frac{\pi}{4} \log \frac{1}{2}$$

$$48. A$$

$$49. C$$

$$50. A$$

$$51. C$$

$$52. D$$

$$53. C$$

$$54. D$$

$$55. D$$

$$56. D$$

$$57. A$$

$$58. D$$

$$59. e^{-1}$$

$$60. \frac{e^x}{x^4} c$$

$$61. \frac{1}{2}$$

$$62. \frac{-1}{2\sqrt{3}} \tan^{-1} \frac{2\cos x}{\sqrt{3}} c$$

$$63. 0$$

8.3 EXERCISE

$$1. \frac{1}{2} \text{ sq. units}$$

$$2. \frac{4}{3} p^2 \text{ sq. units}$$

$$3. 10 \text{ sq. units}$$

$$4. \frac{16}{3} \text{ sq. units}$$

$$5. \frac{27}{2} \text{ sq. units}$$

$$6. \frac{9}{2} \text{ sq. units}$$

$$7. \frac{32}{3} \text{ sq. units}$$

$$8. 2\pi \text{ sq. units}$$

$$9. \frac{4}{3} \text{ sq. units}$$

$$10. 96 \text{ sq. units}$$

$$11. \frac{16}{3} \text{ sq. units}$$

$$12. \frac{\pi a^2}{4} \text{ sq. units}$$

$$13. \frac{1}{6} \text{ sq. units}$$

$$14. \frac{9}{2} \text{ sq. units}$$

$$15. 9 \text{ sq. units}$$

$$16. 2 \left[\pi - \frac{8}{3} \right] \text{ sq. units}$$

$$17. 4 \text{ sq. units}$$

$$18. \frac{15}{2} \text{ sq. units}$$

$$19. \frac{4}{3} (\sqrt{3} + 2\pi) a^2 \text{ sq. units}$$

$$20. 6 \text{ sq. units}$$

$$21. \frac{15}{2} \text{ sq. units}$$

$$22. 8 \text{ sq. units}$$

$$23. 15 \text{ sq. units}$$

$$24. C$$

$$25. D$$

$$26. A$$

$$27. B$$

28. A 29. A 30. D 31. A
 32. B 33. A 34. C

9.3 EXERCISE

1. $2^x - 2^{-y} = k$ 2. $\frac{d^2y}{dx^2} = 0$ 3. $\frac{e^6 - 9}{2}$
4. $y(x^2 - 1) = \frac{1}{2} \log \left(\left| \frac{x-1}{x+1} \right| \right) + k$ 5. $y = c.e^{x-x^2}$
6. $(a+m)y = e^{mx} + ce^{-ax}$ 7. $(x-c)e^{x+y} + 1 = 0$
8. $y = kxe^{\frac{-x^2}{2}}$ 9. $y = \tan^{-1} x + \frac{x^2}{2}$ 10. $x^2 - y^2 = c$ 11. $\frac{1}{3}$
13. $(1-x^2)\frac{d^2y}{dx^2} - x\frac{dy}{dx} - 2 = 0$ 14. $x^2 - y^2 \frac{dy}{dx} - 2xy = 0$
15. $y = \frac{4x^3}{3 + x^2}$ 16. $\tan^{-1} \left(\frac{y}{x} \right) = \log|x| + c$
17. $2xe^{\tan^{-1}y} = e^{2\tan^{-1}y} + c$ 18. $\tan^{-1} \left(\frac{x}{y} \right) + \log y = c$
19. $x^2 - y^2 = k e^{x-y}$ 20. $x^2 - y^2 = 3^3 e^{y^2}$ 21. $y \sin x = \frac{-\cos 2x}{2} + \frac{3}{2}$
22. $xy y'' + x(y')^2 - yy' = 0$ 23. $\frac{1}{2} (\tan^{-1} x)^2 + \log(1+y^2) = c$
24. $x-1 - y-2 \frac{dy}{dx} = 0$ 25. $y = -\cos x - \frac{2 \sin x}{x} - \frac{2 \cos x}{x^2} - \frac{x \log x}{3} - \frac{x}{9} - cx^{-2}$

$$26. \quad x \sin y \cos y \sin y \quad ce^{-y}$$

$$27. \quad \log \left| 1 + \tan \frac{x-y}{2} \right| \quad x \quad c$$

$$28. \quad y - \frac{3 \sin 2x - 2 \cos 2x}{13} \quad ce^{3x}$$

$$29. \quad 2x^2 - y^2 \quad 3x$$

$$30. \quad y-1 \quad x+1 \quad 2x \quad 0$$

$$31. \quad ke^{2x} \quad 1-x \quad y+1 \quad x-y$$

$$32. \quad xy = 1 \quad 33. \quad \log \left(\frac{x}{y} \right) = cx$$

$$34. \quad D \quad 35. \quad C$$

$$36. \quad A \quad 37. \quad C \quad 38. \quad B \quad 39. \quad C$$

$$40. \quad C \quad 41. \quad D \quad 42. \quad A \quad 43. \quad C$$

$$44. \quad D \quad 45. \quad B \quad 46. \quad B \quad 47. \quad C$$

$$48. \quad C \quad 49. \quad D \quad 50. \quad A \quad 51. \quad A$$

$$52. \quad B \quad 53. \quad B \quad 54. \quad B \quad 55. \quad B$$

$$56. \quad C \quad 57. \quad B \quad 58. \quad A \quad 59. \quad A$$

$$60. \quad C \quad 61. \quad C \quad 62. \quad D \quad 63. \quad C$$

$$64. \quad C \quad 65. \quad A \quad 66. \quad D \quad 67. \quad D$$

$$68. \quad C \quad 69. \quad C \quad 70. \quad A \quad 71. \quad A$$

$$72. \quad A \quad 73. \quad C \quad 74. \quad B \quad 75. \quad A$$

$$76. \quad \text{(i) not defined} \quad \text{(ii) not defined} \quad \text{(iii) 3}$$

$$\text{(iv) } \frac{dy}{dx} + py = Q$$

$$\text{(v) } xe^{\int p_1 dy} = \int (Q_1 \times e^{\int p_1 dy}) dy + c$$

$$\text{(vi) } y = \frac{x^2}{4} \quad cx^2$$

$$\text{(vii) } 3y + 1 - x^2 - 4x^3 = c$$

$$\text{(viii) } xy = Ae^{-y}$$

$$\text{(ix) } y = ce^{-x} \quad \frac{\sin x}{2} - \frac{\cos x}{2}$$

$$\text{(x) } x = c \sec y$$

$$\text{(xi) } \frac{e^x}{x}$$

77. (i) True (ii) True (iii) True (iv) True
 (v) False (vi) False (vii) True (viii) True
 (ix) True (x) True (xi) True

10.3 EXERCISE

1. $\frac{1}{3} 2\hat{i} \hat{j} 2\hat{k}$ 2. (i) $\frac{1}{3} 2\hat{i} \hat{j} - 2\hat{k}$ (ii) $\frac{1}{\sqrt{37}} \hat{j} 6\hat{k}$
3. $\frac{1}{7} -2\hat{i} 3\hat{j} - 6\hat{k}$ 4. $\vec{c} = \frac{3\vec{b} - \vec{a}}{2}$ 5. $k = -2$ 6. $2 \hat{i} \hat{j} \hat{k}$
7. $\frac{2}{7}, \frac{3}{7}, \frac{-6}{7}; 4\hat{i}, 6\hat{j}, -12\hat{k}$ 8. $2\hat{i} 4\hat{j} 4\hat{k}$ 9. $\cos^{-1} \frac{1}{\sqrt{156}}$

10. Area of the parallelograms formed by taking any two sides represented by \vec{a}, \vec{b} and \vec{c} as adjacent are equal

11. $\frac{2}{\sqrt{7}}$ 12. $\sqrt{21}$ 13. $\frac{\sqrt{274}}{2}$
16. $\hat{n} \begin{vmatrix} \vec{a} & \vec{b} & \vec{c} \\ \vec{a} & \vec{b} & \vec{c} \end{vmatrix}$ 17. $\frac{\sqrt{62}}{2}$

18. $\frac{1}{3} 5\vec{i} 2\vec{j} 2\vec{k}$

19. C 20. D 21. C 22. B
 23. D 24. A 25. D 26. D
 27. D 28. A 29. C 30. A
 31. C 32. C 33. B

34. If \vec{a} and \vec{b} are equal vectors

35. 0 36. $\frac{1}{4}$ 37. $k \in]-1, 1[[k \neq -\frac{1}{2}]$ 38. $|\vec{a}|^2 |\vec{b}|^2$
39. 3 40. \vec{a} 41. True 42. True
43. True 44. False 45. False

11.3 EXERCISE

1. $5\hat{i} + 5\sqrt{2}\hat{j} + 5\hat{k}$ 2. $(x-1)\hat{i} + (y+2)\hat{j} + (z-3)\hat{k} = \lambda(3\hat{j} - 2\hat{j} + 6\hat{k})$
3. $(-1, -1, -1)$

4. $\cos^{-1}\left(\frac{19}{21}\right)$ 7. $x + y + 2z = 19$ 8. $x + y + z = 9$
9. $3x - 2y + 6z - 27 = 0$ 10. $21x + 9y - 3z - 51 = 0$
11. $\frac{x}{1} = \frac{y}{2} = \frac{z}{-1}$ and $\frac{x}{-1} = \frac{y}{1} = \frac{z}{-2}$ 12. 60°
14. $ax + by + cz = a^2 + b^2 + c^2$ 14. $(1, 1)$
15. 15° or 75° 16. $(2, 6, -2)$ $3\sqrt{5}$
17. 7 18. $\sqrt{6}$
19. $(x-3)\hat{j} + y\hat{j} + (z-1)\hat{k} = \lambda(-2\hat{i} + \hat{j} + 3\hat{k})$
20. $18x + 17y + 4z = 49$ 21. 14 22. $51x + 15y - 50z + 173 = 0$
24. $4x + 2y - 4z - 6 = 0$ and $-2x + 4y + 4z - 6 = 0$
26. $3\hat{i} + 8\hat{j} + 3\hat{k}, -3\hat{i} - 7\hat{j} + 6\hat{k}$ 29. D 30. D
31. A 32. D 33. D 34. A
35. D 36. C 37. $\frac{x}{2} + \frac{y}{3} + \frac{z}{4} = 1$
38. $\frac{2}{3}, \frac{2}{3}, \frac{-1}{3}$ 39. $(x-5)\hat{i} + (y+4)\hat{j} + (z-6)\hat{k} = \lambda(3\hat{i} + 7\hat{j} + 2\hat{k})$
40. $(x-3)\hat{i} + (y-4)\hat{j} + (z+7)\hat{k} = \lambda(-2\hat{i} - 5\hat{j} + 13\hat{k})$ 41. $x + y - z = 2$
42. True 43. True 44. False 45. False
46. True 47. True 48. False 49. True

12.3 EXERCISE

1. 42 2. 4 3. 47 4. -30
5. 196 6. 43 7. 21 8. 47
9. Minimum value = 3 10. Maximum = 9, minimum = $3\frac{1}{7}$

11. Maximise $Z = 50x - 60y$, subject to:

$$2x + y \leq 20, x + 2y \leq 12, x + 3y \leq 15, x \geq 0, y \geq 0$$

12. Minimise $Z = 400x - 200y$, subject to:

$$5x - 2y \leq 30$$

$$2x - y \leq 15$$

$$x \geq y, x \geq 0, y \geq 0$$

13. Maximise $Z = 100x - 170y$ subject to :

$$3x - 2y \leq 3600, x - 4y \leq 1800, x \geq 0, y \geq 0$$

14. Maximise $Z = 200x - 120y$ subject to :

$$x - y \leq 300, 3x - y \leq 600, y \geq x - 100, x \geq 0, y \geq 0$$

15. Maximise $Z = x - y$, subject to

$$2x + 3y \leq 120, 8x + 5y \leq 400, x \geq 0, y \geq 0$$

16. Type A : 6, Type B : 3; Maximum profit = Rs. 480

17. 2571.43

18. 138600

19. 150 sweaters of each type and maximum profit = Rs 48,000

20. $54\frac{2}{7}$ km.

21. $3\frac{10}{11}$

22. Model X : 25, Model Y : 30 and maximum profit = Rs 40,000

23. Tablet X : 1, Tablet Y : 6

24. Factory I : 80 days, Factory II : 60 days

25. Maximum : 12, Minimum does not exist

26. B

27. B

28. A

29. D

30. C

31. D

32. D

33. A

34. B

35. Linear constraints

36. Linear

37. Unbounded

38. Maximum

39. Bounded

40. Intersection

41. Convex

42. True

43. False

44. False

45. True

13.3 EXERCISE

1. Independent 2. not independent 3. 1.1 4. $\frac{25}{56}$
5. $P(E) = \frac{1}{12}$, $P(F) = \frac{5}{18}$, $P(G) = \frac{7}{36}$, no pair is independent
7. (i) $\frac{3}{4}$, (ii) $\frac{1}{2}$, (iii) $\frac{1}{4}$, (iv) $\frac{5}{8}$ 8. $\frac{3}{4}$, $\frac{3}{10}$
9. (i) E_1 and E_2 occur
 (ii) E_1 does not occur, but E_2 occurs
 (iii) Either E_1 or E_2 , or both E_1 and E_2 occurs
 (iv) Either E_1 or E_2 occurs, but not both
10. (i) $\frac{1}{3}$, (ii) $\frac{23}{18}$ 12. $\frac{\sqrt{3}}{2}$ 13. Rs 0.50 14. $\frac{1}{10}$
15. Expectation = Rs 0.65 16. $\frac{85}{153}$ 17. $\frac{7}{15}$
18. $\frac{5}{9}$ 19. $\frac{1}{270725}$ 20. $\frac{5}{16}$ 21. $\frac{7}{128}$
22. $\frac{4547}{8192}$ 23. $1 - \frac{9}{10}^8$ 24. (i) .1118 (ii) .4475
25. (i) $\frac{8}{15}$, (ii) $\frac{14}{15}$, $\frac{1}{15}$, (iii) 1 26. 0.7 (approx.) 27. 0.18
28. $\frac{1}{2}$ 29.

X	0	1	2
P(X)	.54	.42	.04
31. (i) $\left(\frac{49}{50}\right)^{10}$ (ii) $\frac{45(49)^8}{(50)^{10}}$ (iii) $\frac{59(49)^9}{(50)^{10}}$

32. $\frac{1}{3}$

33. $\frac{9}{44}$

34. $\frac{p-1}{n-1}$

35.

X	1	2	3	4	5	6
P(X)	$\frac{1}{36}$	$\frac{2}{36}$	$\frac{3}{36}$	$\frac{4}{36}$	$\frac{5}{36}$	$\frac{6}{36}$

36. $p = \frac{1}{2}$

37. $\frac{665}{324}$

38. $\frac{775}{7776}$

39. not independent

41. (i) $\frac{7}{18}$, (ii) $\frac{11}{18}$

42. (i) $\frac{2}{11}$, (ii) $\frac{9}{11}$

43. (i) 0.49, (ii) 0.65, (iii) .314

44. $\frac{7}{11}$

45. $\frac{11}{21}$

46. $\frac{1}{3}$

47. $\frac{110}{221}$

48. $\frac{5}{11}$

49. (i) $\frac{1}{50}$, (ii) 5.2, (iii) 1.7 (approx.)

50. (i) 3, (ii) 19.05

51. (i) 4.32, (ii) 61.9, (iii) $\frac{15}{22}$

52. 10

53. Mean $\frac{2}{13}$, S.D. = 0.377

54. $\frac{1}{2}$

55. Mean = 6, Variance = 3

56. C

57. A

58. D

59. C

60. C

61. D

62. B

63. D

64. C

65. D

66. D

67. D

68. C

69. D

70. D

71. D

72. C

73. C

74. C

75. B

76. B

77. D

78. C

79. A

80. D

81. B

82. C

83. C

84. A

85. B

86. A

87. C

88. D

89. D

90. A

91. B

92. D 93. D 94. False 95. True
96. False 97. False 98. True 99. True
100. True 101. True 102. False 103. True
104. $\frac{1}{3}$ 105. $\frac{10}{9}$ 106. $\frac{1}{10}$
107. $\sum p_i x_i^2 - (\sum p_i x_i)^2$ 108. independent