



CHAPTER 1

Chemical Reactions and Equations

Multiple Choice Questions

- Which of the following is not a physical change?
 - Boiling of water to give water vapour
 - Melting of ice to give water
 - Dissolution of salt in water
 - Combustion of Liquefied Petroleum Gas (LPG)
- The following reaction is an example of a
$$4\text{NH}_3(\text{g}) + 5\text{O}_2(\text{g}) \rightarrow 4\text{NO}(\text{g}) + 6\text{H}_2\text{O}(\text{g})$$
 - displacement reaction
 - combination reaction
 - redox reaction
 - neutralisation reaction
 - (i) and (iv)
 - (ii) and (iii)
 - (i) and (iii)
 - (iii) and (iv)
- Which of the following statements about the given reaction are correct?
$$3\text{Fe}(\text{s}) + 4\text{H}_2\text{O}(\text{g}) \rightarrow \text{Fe}_3\text{O}_4(\text{s}) + 4\text{H}_2(\text{g})$$
 - Iron metal is getting oxidised
 - Water is getting reduced
 - Water is acting as reducing agent
 - Water is acting as oxidising agent
 - (i), (ii) and (iii)
 - (iii) and (iv)
 - (i), (ii) and (iv)
 - (ii) and (iv)
- Which of the following are exothermic processes?
 - Reaction of water with quick lime
 - Dilution of an acid
 - Evaporation of water
 - Sublimation of camphor (crystals)
 - (i) and (ii)
 - (ii) and (iii)
 - (i) and (iv)
 - (iii) and (iv)

5. Three beakers labelled as A, B and C each containing 25 mL of water were taken. A small amount of NaOH, anhydrous CuSO_4 and NaCl were added to the beakers A, B and C respectively. It was observed that there was an increase in the temperature of the solutions contained in beakers A and B, whereas in case of beaker C, the temperature of the solution falls. Which one of the following statement(s) is(are) correct?

- (i) In beakers A and B, exothermic process has occurred.
- (ii) In beakers A and B, endothermic process has occurred.
- (iii) In beaker C exothermic process has occurred.
- (iv) In beaker C endothermic process has occurred.

- (a) (i) only
- (b) (ii) only
- (c) (i) and (iv)
- (d) (ii) and (iii)

6. A dilute ferrous sulphate solution was gradually added to the beaker containing acidified permanganate solution. The light purple colour of the solution fades and finally disappears. Which of the following is the correct explanation for the observation?

- (a) KMnO_4 is an oxidising agent, it oxidises FeSO_4
- (b) FeSO_4 acts as an oxidising agent and oxidises KMnO_4
- (c) The colour disappears due to dilution; no reaction is involved
- (d) KMnO_4 is an unstable compound and decomposes in presence of FeSO_4 to a colourless compound.

7. Which among the following is(are) double displacement reaction(s)?

- (i) $\text{Pb} + \text{CuCl}_2 \rightarrow \text{PbCl}_2 + \text{Cu}$
- (ii) $\text{Na}_2\text{SO}_4 + \text{BaCl}_2 \rightarrow \text{BaSO}_4 + 2\text{NaCl}$
- (iii) $\text{C} + \text{O}_2 \rightarrow \text{CO}_2$
- (iv) $\text{CH}_4 + 2\text{O}_2 \rightarrow \text{CO}_2 + 2\text{H}_2\text{O}$

- (a) (i) and (iv)
- (b) (ii) only
- (c) (i) and (ii)
- (d) (iii) and (iv)

8. Which among the following statement(s) is(are) true? Exposure of silver chloride to sunlight for a long duration turns grey due to

- (i) the formation of silver by decomposition of silver chloride
- (ii) sublimation of silver chloride
- (iii) decomposition of chlorine gas from silver chloride
- (iv) oxidation of silver chloride

- (a) (i) only
- (b) (i) and (iii)
- (c) (ii) and (iii)
- (d) (iv) only

9. Solid calcium oxide reacts vigorously with water to form calcium hydroxide accompanied by liberation of heat. This process is called slaking of lime. Calcium hydroxide dissolves in water to form its solution called lime water. Which among the following is (are) true about slaking of lime and the solution formed?
- (i) It is an endothermic reaction
 - (ii) It is an exothermic reaction
 - (iii) The pH of the resulting solution will be more than seven
 - (iv) The pH of the resulting solution will be less than seven
- (a) (i) and (ii) (b) (ii) and (iii)
(c) (i) and (iv) (d) (iii) and (iv)
10. Barium chloride on reacting with ammonium sulphate forms barium sulphate and ammonium chloride. Which of the following correctly represents the type of the reaction involved?
- (i) Displacement reaction
 - (ii) Precipitation reaction
 - (iii) Combination reaction
 - (iv) Double displacement reaction
- (a) (i) only (b) (ii) only
(c) (iv) only (d) (ii) and (iv)
11. Electrolysis of water is a decomposition reaction. The mole ratio of hydrogen and oxygen gases liberated during electrolysis of water is
- (a) 1:1
 - (b) 2:1
 - (c) 4:1
 - (d) 1:2
12. Which of the following is(are) an endothermic process(es)?
- (i) Dilution of sulphuric acid
 - (ii) Sublimation of dry ice
 - (iii) Condensation of water vapours
 - (iv) Evaporation of water
- (a) (i) and (iii) (b) (ii) only
(c) (iii) only (d) (ii) and (iv)
13. In the double displacement reaction between aqueous potassium iodide and aqueous lead nitrate, a yellow precipitate of lead iodide is formed. While performing the activity if lead nitrate is not available, which of the following can be used in place of lead nitrate?
- (a) Lead sulphate (insoluble)
 - (b) Lead acetate
 - (c) Ammonium nitrate
 - (d) Potassium sulphate

- 14.** Which of the following gases can be used for storage of fresh sample of an oil for a long time?
- (a) Carbon dioxide or oxygen
 - (b) Nitrogen or oxygen
 - (c) Carbon dioxide or helium
 - (d) Helium or nitrogen

- 15.** The following reaction is used for the preparation of oxygen gas in the laboratory

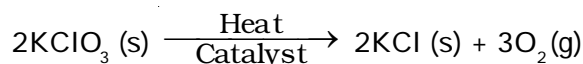

Which of the following statement(s) is(are) correct about the reaction?

- (a) It is a decomposition reaction and endothermic in nature
 - (b) It is a combination reaction
 - (c) It is a decomposition reaction and accompanied by release of heat
 - (d) It is a photochemical decomposition reaction and exothermic in nature
- 16.** Which one of the following processes involve chemical reactions?
- (a) Storing of oxygen gas under pressure in a gas cylinder
 - (b) Liquefaction of air
 - (c) Keeping petrol in a china dish in the open
 - (d) Heating copper wire in presence of air at high temperature
- 17.** In which of the following chemical equations, the abbreviations represent the correct states of the reactants and products involved at reaction temperature?
- (a) $2\text{H}_2(\text{l}) + \text{O}_2(\text{l}) \rightarrow 2\text{H}_2\text{O}(\text{g})$
 - (b) $2\text{H}_2(\text{g}) + \text{O}_2(\text{l}) \rightarrow 2\text{H}_2\text{O}(\text{l})$
 - (c) $2\text{H}_2(\text{g}) + \text{O}_2(\text{g}) \rightarrow 2\text{H}_2\text{O}(\text{l})$
 - (d) $2\text{H}_2(\text{g}) + \text{O}_2(\text{g}) \rightarrow 2\text{H}_2\text{O}(\text{g})$

- 18.** Which of the following are combination reactions?

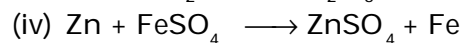
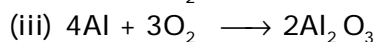
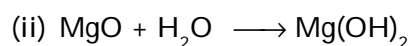

- (a) (i) and (iii)
- (b) (iii) and (iv)
- (c) (ii) and (iv)
- (d) (ii) and (iii)

Short Answer Questions

- 19.** Write the balanced chemical equations for the following reactions and identify the type of reaction in each case.
- Nitrogen gas is treated with hydrogen gas in the presence of a catalyst at 773K to form ammonia gas.
 - Sodium hydroxide solution is treated with acetic acid to form sodium acetate and water.
 - Ethanol is warmed with ethanoic acid to form ethyl acetate in the presence of concentrated H_2SO_4 .
 - Ethene is burnt in the presence of oxygen to form carbon dioxide, water and releases heat and light.
- 20.** Write the balanced chemical equations for the following reactions and identify the type of reaction in each case.
- Thermit reaction, iron (III) oxide reacts with aluminium and gives molten iron and aluminium oxide.
 - Magnesium ribbon is burnt in an atmosphere of nitrogen gas to form solid magnesium nitride.
 - Chlorine gas is passed in an aqueous potassium iodide solution to form potassium chloride solution and solid iodine.
 - Ethanol is burnt in air to form carbon dioxide, water and releases heat.
- 21.** Complete the missing components/variables given as **x** and **y** in the following reactions
- $\text{Pb}(\text{NO}_3)_2(\text{aq}) + 2\text{KI}(\text{aq}) \longrightarrow \text{PbI}_2(\mathbf{x}) + 2\text{KNO}_3(\mathbf{y})$
 - $\text{Cu}(\text{s}) + 2\text{AgNO}_3(\text{aq}) \longrightarrow \text{Cu}(\text{NO}_3)_2(\text{aq}) + \mathbf{x}(\text{s})$
 - $\text{Zn}(\text{s}) + \text{H}_2\text{SO}_4(\text{aq}) \longrightarrow \text{ZnSO}_4(\mathbf{x}) + \text{H}_2(\mathbf{y})$
 - $\text{CaCO}_3(\text{s}) \xrightarrow{\mathbf{x}} \text{CaO}(\text{s}) + \text{CO}_2(\text{g})$
- 22.** Which among the following changes are exothermic or endothermic in nature?
- Decomposition of ferrous sulphate
 - Dilution of sulphuric acid
 - Dissolution of sodium hydroxide in water
 - Dissolution of ammonium chloride in water
- 23.** Identify the reducing agent in the following reactions
- $4\text{NH}_3 + 5\text{O}_2 \longrightarrow 4\text{NO} + 6\text{H}_2\text{O}$
 - $\text{H}_2\text{O} + \text{F}_2 \longrightarrow \text{HF} + \text{HOF}$
 - $\text{Fe}_2\text{O}_3 + 3\text{CO} \longrightarrow 2\text{Fe} + 3\text{CO}_2$
 - $2\text{H}_2 + \text{O}_2 \longrightarrow 2\text{H}_2\text{O}$

24. Identify the oxidising agent (oxidant) in the following reactions

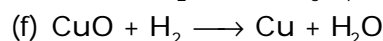
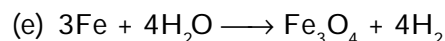
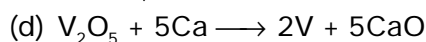
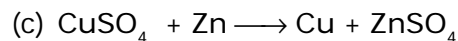
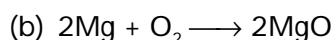
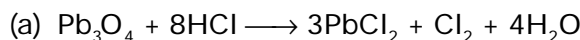

25. Write the balanced chemical equations for the following reactions

(a) Sodium carbonate on reaction with hydrochloric acid in equal molar concentrations gives sodium chloride and sodium hydrogencarbonate.

(b) Sodium hydrogencarbonate on reaction with hydrochloric acid gives sodium chloride, water and liberates carbon dioxide.

(c) Copper sulphate on treatment with potassium iodide precipitates cuprous iodide (Cu_2I_2), liberates iodine gas and also forms potassium sulphate.

26. A solution of potassium chloride when mixed with silver nitrate solution, an insoluble white substance is formed. Write the chemical reaction involved and also mention the type of the chemical reaction?

27. Ferrous sulphate decomposes with the evolution of a gas having a characteristic odour of burning sulphur. Write the chemical reaction involved and identify the type of reaction.

28. Why do fire flies glow at night?

29. Grapes hanging on the plant do not ferment but after being plucked from the plant can be fermented. Under what conditions do these grapes ferment? Is it a chemical or a physical change?

30. Which among the following are physical or chemical changes?

(a) Evaporation of petrol

(b) Burning of Liquefied Petroleum Gas (LPG)

(c) Heating of an iron rod to red hot.

(d) Curdling of milk

(e) Sublimation of solid ammonium chloride

31. During the reaction of some metals with dilute hydrochloric acid, following observations were made.

(a) Silver metal does not show any change

(b) The temperature of the reaction mixture rises when aluminium (Al) is added.

(c) The reaction of sodium metal is found to be highly explosive

(d) Some bubbles of a gas are seen when lead (Pb) is reacted with the acid.

Explain these observations giving suitable reasons.

- 32.** A substance X, which is an oxide of a group 2 element, is used intensively in the cement industry. This element is present in bones also. On treatment with water it forms a solution which turns red litmus blue. Identify X and also write the chemical reactions involved.
- 33.** Write a balanced chemical equation for each of the following reactions and also classify them.
- Lead acetate solution is treated with dilute hydrochloric acid to form lead chloride and acetic acid solution.
 - A piece of sodium metal is added to absolute ethanol to form sodium ethoxide and hydrogen gas.
 - Iron (III) oxide on heating with carbon monoxide gas reacts to form solid iron and liberates carbon dioxide gas.
 - Hydrogen sulphide gas reacts with oxygen gas to form solid sulphur and liquid water.
- 34.** Why do we store silver chloride in dark coloured bottles?
- 35.** Balance the following chemical equations and identify the type of chemical reaction.
- $\text{Mg(s)} + \text{Cl}_2\text{(g)} \longrightarrow \text{MgCl}_2\text{(s)}$
 - $\text{HgO(s)} \xrightarrow{\text{Heat}} \text{Hg(l)} + \text{O}_2\text{(g)}$
 - $\text{Na(s)} + \text{S(s)} \xrightarrow{\text{Fuse}} \text{Na}_2\text{S(s)}$
 - $\text{TiCl}_4\text{(l)} + \text{Mg(s)} \longrightarrow \text{Ti(s)} + \text{MgCl}_2\text{(s)}$
 - $\text{CaO(s)} + \text{SiO}_2\text{(s)} \longrightarrow \text{CaSiO}_3\text{(s)}$
 - $\text{H}_2\text{O}_2\text{(l)} \xrightarrow{\text{UV}} \text{H}_2\text{O(l)} + \text{O}_2\text{(g)}$
- 36.** A magnesium ribbon is burnt in oxygen to give a white compound X accompanied by emission of light. If the burning ribbon is now placed in an atmosphere of nitrogen, it continues to burn and forms a compound Y.
- Write the chemical formulae of X and Y.
 - Write a balanced chemical equation, when X is dissolved in water.
- 37.** Zinc liberates hydrogen gas when reacted with dilute hydrochloric acid, whereas copper does not. Explain why?
- 38.** A silver article generally turns black when kept in the open for a few days. The article when rubbed with toothpaste again starts shining.
- Why do silver articles turn black when kept in the open for a few days? Name the phenomenon involved.
 - Name the black substance formed and give its chemical formula.

Long Answer Questions

- 39.** On heating blue coloured powder of copper (II) nitrate in a boiling tube, copper oxide (black), oxygen gas and a brown gas X is formed
- Write a balanced chemical equation of the reaction.
 - Identify the brown gas X evolved.
 - Identify the type of reaction.
 - What could be the pH range of aqueous solution of the gas X?
- 40.** Give the characteristic tests for the following gases
- CO_2
 - SO_2
 - O_2
 - H_2
- 41.** What happens when a piece of
- zinc metal is added to copper sulphate solution?
 - aluminium metal is added to dilute hydrochloric acid?
 - silver metal is added to copper sulphate solution?
- Also, write the balanced chemical equation if the reaction occurs
- 42.** What happens when zinc granules are treated with dilute solution of H_2SO_4 , HCl , HNO_3 , NaCl and NaOH , also write the chemical equations if reaction occurs.
- 43.** On adding a drop of barium chloride solution to an aqueous solution of sodium sulphite, white precipitate is obtained.
- Write a balanced chemical equation of the reaction involved
 - What other name can be given to this precipitation reaction?
 - On adding dilute hydrochloric acid to the reaction mixture, white precipitate disappears. Why?
- 44.** You are provided with two containers made up of copper and aluminium. You are also provided with solutions of dilute HCl , dilute HNO_3 , ZnCl_2 and H_2O . In which of the above containers these solutions can be kept?

CHAPTER 2

Acids, Bases and Salts

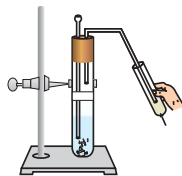

Multiple Choice Questions

1. What happens when a solution of an acid is mixed with a solution of a base in a test tube?
 - (i) The temperature of the solution increases
 - (ii) The temperature of the solution decreases
 - (iii) The temperature of the solution remains the same
 - (iv) Salt formation takes place

(a) (i) only (b) (i) and (iii)
(c) (ii) and (iii) (d) (i) and (iv)
2. An aqueous solution turns red litmus solution blue. Excess addition of which of the following solution would reverse the change?
 - (a) Baking powder
 - (b) Lime
 - (c) Ammonium hydroxide solution
 - (d) Hydrochloric acid
3. During the preparation of hydrogen chloride gas on a humid day, the gas is usually passed through the guard tube containing calcium chloride. The role of calcium chloride taken in the guard tube is to
 - (a) absorb the evolved gas
 - (b) moisten the gas
 - (c) absorb moisture from the gas
 - (d) absorb Cl^- ions from the evolved gas
4. Which of the following salts does not contain water of crystallisation?
 - (a) Blue vitriol
 - (b) Baking soda
 - (c) Washing soda
 - (d) Gypsum

- 5.** Sodium carbonate is a basic salt because it is a salt of
- (a) strong acid and strong base
 - (b) weak acid and weak base
 - (c) strong acid and weak base
 - (d) weak acid and strong base
- 6.** Calcium phosphate is present in tooth enamel. Its nature is
- (a) basic
 - (b) acidic
 - (c) neutral
 - (d) amphoteric
- 7.** A sample of soil is mixed with water and allowed to settle. The clear supernatant solution turns the pH paper yellowish-orange. Which of the following would change the colour of this pH paper to greenish-blue?
- (a) Lemon juice
 - (b) Vinegar
 - (c) Common salt
 - (d) An antacid
- 8.** Which of the following gives the correct increasing order of acidic strength?
- (a) Water < Acetic acid < Hydrochloric acid
 - (b) Water < Hydrochloric acid < Acetic acid
 - (c) Acetic acid < Water < Hydrochloric acid
 - (d) Hydrochloric acid < Water < Acetic acid
- 9.** If a few drops of a concentrated acid accidentally spills over the hand of a student, what should be done?
- (a) Wash the hand with saline solution
 - (b) Wash the hand immediately with plenty of water and apply a paste of sodium hydrogencarbonate
 - (c) After washing with plenty of water apply solution of sodium hydroxide on the hand
 - (d) Neutralise the acid with a strong alkali
- 10.** Sodium hydrogencarbonate when added to acetic acid evolves a gas. Which of the following statements are true about the gas evolved?
- (i) It turns lime water milky
 - (ii) It extinguishes a burning splinter
 - (iii) It dissolves in a solution of sodium hydroxide
 - (iv) It has a pungent odour
- (a) (i) and (ii) (b) (i), (ii) and (iii)
(c) (ii), (iii) and (iv) (d) (i) and (iv)

- 11.** Common salt besides being used in kitchen can also be used as the raw material for making
- (i) washing soda
 - (ii) bleaching powder
 - (iii) baking soda
 - (iv) slaked lime
- (a) (i) and (ii) (b) (i), (ii) and (iv)
(c) (i) and (iii) (d) (i), (iii) and (iv)
- 12.** One of the constituents of baking powder is sodium hydrogencarbonate, the other constituent is
- (a) hydrochloric acid
 - (b) tartaric acid
 - (c) acetic acid
 - (d) sulphuric acid
- 13.** To protect tooth decay we are advised to brush our teeth regularly. The nature of the tooth paste commonly used is
- (a) acidic
 - (b) neutral
 - (c) basic
 - (d) corrosive
- 14.** Which of the following statements is correct about an aqueous solution of an acid and of a base?
- (i) Higher the pH, stronger the acid
 - (ii) Higher the pH, weaker the acid
 - (iii) Lower the pH, stronger the base
 - (iv) Lower the pH, weaker the base
- (a) (i) and (iii) (b) (ii) and (iii)
(c) (i) and (iv) (d) (ii) and (iv)
- 15.** The pH of the gastric juices released during digestion is
- (a) less than 7
 - (b) more than 7
 - (c) equal to 7
 - (d) equal to 0
- 16.** Which of the following phenomena occur, when a small amount of acid is added to water?
- (i) Ionisation
 - (ii) Neutralisation
 - (iii) Dilution
 - (iv) Salt formation
- (a) (i) and (ii) (b) (i) and (iii)
(c) (ii) and (iii) (d) (ii) and (iv)

- 17.** Which one of the following can be used as an acid–base indicator by a visually impaired student?
- Litmus
 - Turmeric
 - Vanilla essence
 - Petunia leaves
- 18.** Which of the following substance will not give carbon dioxide on treatment with dilute acid?
- Marble
 - Limestone
 - Baking soda
 - Lime
- 19.** Which of the following is acidic in nature?
- Lime juice
 - Human blood
 - Lime water
 - Antacid

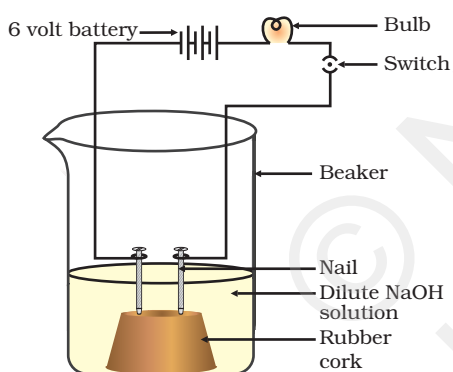

Fig. 2.1

- 20.** In an attempt to demonstrate electrical conductivity through an electrolyte, the following apparatus (Figure 2.1) was set up.

Which among the following statement(s) is(are) correct?

- Bulb will not glow because electrolyte is not acidic
- Bulb will glow because NaOH is a strong base and furnishes ions for conduction.
- Bulb will not glow because circuit is incomplete
- Bulb will not glow because it depends upon the type of electrolytic solution

- (i) and (iii)
- (ii) and (iv)
- (ii) only
- (iv) only

- 21.** Which of the following is used for dissolution of gold?
- Hydrochloric acid
 - Sulphuric acid
 - Nitric acid
 - Aqua regia

22. Which of the following is not a mineral acid?

- (a) Hydrochloric acid
- (b) Citric acid
- (c) Sulphuric acid
- (d) Nitric acid

23. Which among the following is not a base?

- (a) NaOH
- (b) KOH
- (c) NH_4OH
- (d) $\text{C}_2\text{H}_5\text{OH}$

24. Which of the following statements is not correct?

- (a) All metal carbonates react with acid to give a salt, water and carbon dioxide
- (b) All metal oxides react with water to give salt and acid
- (c) Some metals react with acids to give salt and hydrogen
- (d) Some non metal oxides react with water to form an acid

25. Match the chemical substances given in Column (A) with their appropriate application given in Column (B)

Column (A)	Column (B)
(A) Bleaching powder	(i) Preparation of glass
(B) Baking soda	(ii) Production of H_2 and Cl_2
(C) Washing soda	(iii) Decolourisation
(D) Sodium chloride	(iv) Antacid

- (a) A—(ii), B—(i), C—(iv), D—(iii)
- (b) A—(iii), B—(ii), C—(iv), D—(i)
- (c) A—(iii), B—(iv), C—(i), D—(ii)
- (d) A—(ii), B—(iv), C—(i), D—(iii)

26. Equal volumes of hydrochloric acid and sodium hydroxide solutions of same concentration are mixed and the pH of the resulting solution is checked with a pH paper. What would be the colour obtained? (You may use colour guide given in Figure 2.2



Figure 2.2

- (a) Red
- (b) Yellow
- (c) Yellowish green
- (d) Blue

27. Which of the following is(are) true when HCl (g) is passed through water?

- (i) It does not ionise in the solution as it is a covalent compound.
- (ii) It ionises in the solution
- (iii) It gives both hydrogen and hydroxyl ion in the solution
- (iv) It forms hydronium ion in the solution due to the combination of hydrogen ion with water molecule

- (a) (i) only
- (b) (iii) only
- (c) (ii) and (iv)
- (d) (iii) and (iv)

28. Which of the following statements is true for acids?

- (a) Bitter and change red litmus to blue
- (b) Sour and change red litmus to blue
- (c) Sour and change blue litmus to red
- (d) Bitter and change blue litmus to red

29. Which of the following are present in a dilute aqueous solution of hydrochloric acid?

- (a) $\text{H}_3\text{O}^+ + \text{Cl}^-$
- (b) $\text{H}_3\text{O}^+ + \text{OH}^-$
- (c) $\text{Cl}^- + \text{OH}^-$
- (d) unionised HCl

30. Identify the correct representation of reaction occurring during chloralkali process

- (a) $2\text{NaCl}(\text{l}) + 2\text{H}_2\text{O}(\text{l}) \rightarrow 2\text{NaOH}(\text{l}) + \text{Cl}_2(\text{g}) + \text{H}_2(\text{g})$
- (b) $2\text{NaCl}(\text{aq}) + 2\text{H}_2\text{O}(\text{aq}) \rightarrow 2\text{NaOH}(\text{aq}) + \text{Cl}_2(\text{g}) + \text{H}_2(\text{g})$
- (c) $2\text{NaCl}(\text{aq}) + 2\text{H}_2\text{O}(\text{l}) \rightarrow 2\text{NaOH}(\text{aq}) + \text{Cl}_2(\text{aq}) + \text{H}_2(\text{aq})$
- (d) $2\text{NaCl}(\text{aq}) + 2\text{H}_2\text{O}(\text{l}) \rightarrow 2\text{NaOH}(\text{aq}) + \text{Cl}_2(\text{g}) + \text{H}_2(\text{g})$

Short Answer Questions

- 31.** Match the acids given in Column (A) with their correct source given in Column (B)

Column (A)	Column (B)
(a) Lactic acid	(i) Tomato
(b) Acetic acid	(ii) Lemon
(c) Citric acid	(iii) Vinegar
(d) Oxalic acid	(iv) Curd

- 32.** Match the important chemicals given in Column (A) with the chemical formulae given in Column (B)

Column (A)	Column (B)
(a) Plaster of Paris	(i) Ca(OH)_2
(b) Gypsum	(ii) $\text{CaSO}_4 \cdot 1/2 \text{H}_2\text{O}$
(c) Bleaching Powder	(iii) $\text{CaSO}_4 \cdot 2\text{H}_2\text{O}$
(d) Slaked Lime	(iv) CaOCl_2

- 33.** What will be the action of the following substances on litmus paper? Dry HCl gas, Moistened NH_3 gas, Lemon juice, Carbonated soft drink, Curd, Soap solution.
- 34.** Name the acid present in ant sting and give its chemical formula. Also give the common method to get relief from the discomfort caused by the ant sting.
- 35.** What happens when nitric acid is added to egg shell?
- 36.** A student prepared solutions of (i) an acid and (ii) a base in two separate beakers. She forgot to label the solutions and litmus paper is not available in the laboratory. Since both the solutions are colourless, how will she distinguish between the two?
- 37.** How would you distinguish between baking powder and washing soda by heating?
- 38.** Salt A commonly used in bakery products on heating gets converted into another salt B which itself is used for removal of hardness of water and a gas C is evolved. The gas C when passed through lime water, turns it milky. Identify A, B and C.

39. In one of the industrial processes used for manufacture of sodium hydroxide, a gas X is formed as by product. The gas X reacts with lime water to give a compound Y which is used as a bleaching agent in chemical industry. Identify X and Y giving the chemical equation of the reactions involved.

40. Fill in the missing data in the following table

Name of the salt	Formula	Salt obtained from	
		Base	Acid
(i) Ammonium chloride	NH_4Cl	NH_4OH	—
(ii) Copper sulphate	—	—	H_2SO_4
(iii) Sodium chloride	NaCl	NaOH	—
(iv) Magnesium nitrate	$\text{Mg}(\text{NO}_3)_2$	—	HNO_3
(v) Potassium sulphate	K_2SO_4	—	—
(vi) Calcium nitrate	$\text{Ca}(\text{NO}_3)_2$	$\text{Ca}(\text{OH})_2$	—

41. What are strong and weak acids? In the following list of acids, separate strong acids from weak acids.

Hydrochloric acid, citric acid, acetic acid, nitric acid, formic acid, sulphuric acid.

42. When zinc metal is treated with a dilute solution of a strong acid, a gas is evolved, which is utilised in the hydrogenation of oil. Name the gas evolved. Write the chemical equation of the reaction involved and also write a test to detect the gas formed.

Long Answer Questions

43. In the following schematic diagram for the preparation of hydrogen gas as shown in Figure 2.3, what would happen if following changes are made?

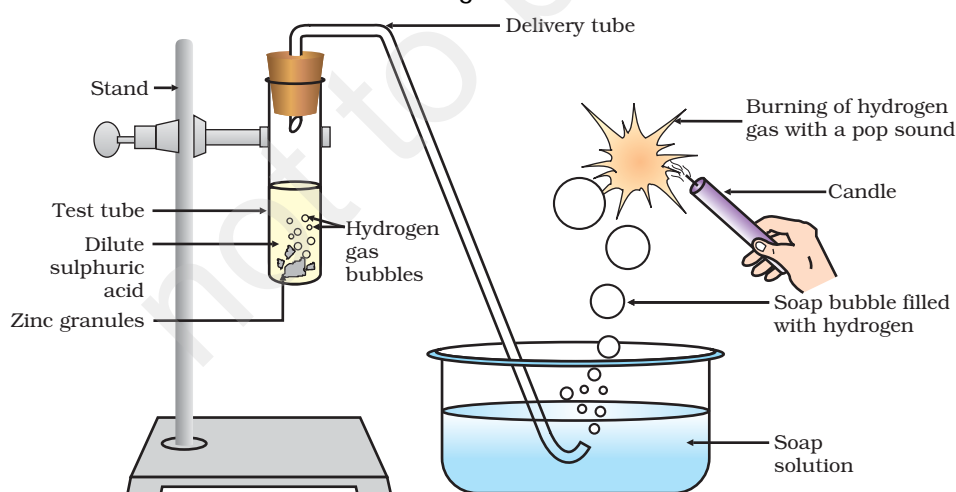

Fig. 2.3

- (a) In place of zinc granules, same amount of zinc dust is taken in the test tube
- (b) Instead of dilute sulphuric acid, dilute hydrochloric acid is taken
- (c) In place of zinc, copper turnings are taken
- (d) Sodium hydroxide is taken in place of dilute sulphuric acid and the tube is heated.
- 44.** For making cake, baking powder is taken. If at home your mother uses baking soda instead of baking powder in cake,
- (a) how will it affect the taste of the cake and why?
- (b) how can baking soda be converted into baking powder?
- (c) what is the role of tartaric acid added to baking soda?
- 45.** A metal carbonate X on reacting with an acid gives a gas which when passed through a solution Y gives the carbonate back. On the other hand, a gas G that is obtained at anode during electrolysis of brine is passed on dry Y, it gives a compound Z, used for disinfecting drinking water. Identify X, Y, G and Z.
- 46.** A dry pellet of a common base B, when kept in open absorbs moisture and turns sticky. The compound is also a by-product of chloralkali process. Identify B. What type of reaction occurs when B is treated with an acidic oxide? Write a balanced chemical equation for one such solution.
- 47.** A sulphate salt of Group 2 element of the Periodic Table is a white, soft substance, which can be moulded into different shapes by making its dough. When this compound is left in open for some time, it becomes a solid mass and cannot be used for moulding purposes. Identify the sulphate salt and why does it show such a behaviour? Give the reaction involved.
- 48.** Identify the compound X on the basis of the reactions given below. Also, write the name and chemical formulae of A, B and C.

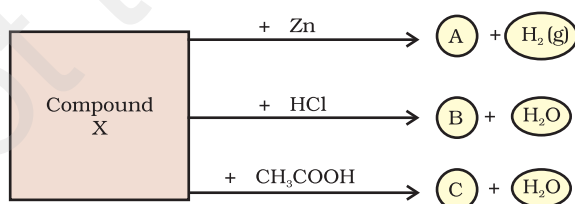
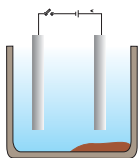

Fig. 2.4

CHAPTER 3



Metals and Non-metals

Multiple Choice Questions

- Which of the following property is generally not shown by metals?
 - Electrical conduction
 - Sonorous in nature
 - Dullness
 - Ductility
- The ability of metals to be drawn into thin wire is known as
 - ductility
 - malleability
 - sonorousity
 - conductivity
- Aluminium is used for making cooking utensils. Which of the following properties of aluminium are responsible for the same?
 - Good thermal conductivity
 - Good electrical conductivity
 - Ductility
 - High melting point

(a) (i) and (ii)	(b) (i) and (iii)
(c) (ii) and (iii)	(d) (i) and (iv)
- Which one of the following metals do not react with cold as well as hot water?
 - Na
 - Ca
 - Mg
 - Fe

5. Which of the following oxide(s) of iron would be obtained on prolonged reaction of iron with steam?
- FeO
 - Fe₂O₃
 - Fe₃O₄
 - Fe₂O₃ and Fe₃O₄
6. What happens when calcium is treated with water?
- It does not react with water
 - It reacts violently with water
 - It reacts less violently with water
 - Bubbles of hydrogen gas formed stick to the surface of calcium
- (i) and (iv)
 - (ii) and (iii)
 - (i) and (ii)
 - (iii) and (iv)
7. Generally metals react with acids to give salt and hydrogen gas. Which of the following acids does not give hydrogen gas on reacting with metals (except Mn and Mg)?
- H₂SO₄
 - HCl
 - HNO₃
 - All of these
8. The composition of aqua-regia is
- Dil.HCl : Conc. HNO₃
3 : 1
 - Conc.HCl : Dil. HNO₃
3 : 1
 - Conc.HCl : Conc.HNO₃
3 : 1
 - Dil.HCl : Dil.HNO₃
3 : 1
9. Which of the following are not ionic compounds?
- KCl
 - HCl
 - CCl₄
 - NaCl
- (i) and (ii)
 - (ii) and (iii)
 - (iii) and (iv)
 - (i) and (iii)

- 10.** Which one of the following properties is not generally exhibited by ionic compounds?
- (a) Solubility in water
 - (b) Electrical conductivity in solid state
 - (c) High melting and boiling points
 - (d) Electrical conductivity in molten state
- 11.** Which of the following metals exist in their native state in nature?
- (i) Cu
 - (ii) Au
 - (iii) Zn
 - (iv) Ag
- (a) (i) and (ii) (b) (ii) and (iii)
(c) (ii) and (iv) (d) (iii) and (iv)
- 12.** Metals are refined by using different methods. Which of the following metals are refined by electrolytic refining?
- (i) Au
 - (ii) Cu
 - (iii) Na
 - (iv) K
- (a) (i) and (ii) (b) (i) and (iii)
(c) (ii) and (iii) (d) (iii) and (iv)
- 13.** Silver articles become black on prolonged exposure to air. This is due to the formation of
- (a) Ag_3N
 - (b) Ag_2O
 - (c) Ag_2S
 - (d) Ag_2S and Ag_3N
- 14.** Galvanisation is a method of protecting iron from rusting by coating with a thin layer of
- (a) Gallium
 - (b) Aluminium
 - (c) Zinc
 - (d) Silver
- 15.** Stainless steel is very useful material for our life. In stainless steel, iron is mixed with
- (a) Ni and Cr
 - (b) Cu and Cr
 - (c) Ni and Cu
 - (d) Cu and Au

- 16.** If copper is kept open in air, it slowly loses its shining brown surface and gains a green coating. It is due to the formation of
- CuSO_4
 - CuCO_3
 - $\text{Cu}(\text{NO}_3)_2$
 - CuO
- 17.** Generally, metals are solid in nature. Which one of the following metals is found in liquid state at room temperature?
- Na
 - Fe
 - Cr
 - Hg
- 18.** Which of the following metals are obtained by electrolysis of their chlorides in molten state ?
- Na
 - Ca
 - Fe
 - Cu
- (a) (i) and (iv) (b) (iii) and (iv)
(c) (i) and (iii) (d) (i) and (ii)
- 19.** Generally, non-metals are not lustrous. Which of the following non-metal is lustrous?
- Sulphur
 - Oxygen
 - Nitrogen
 - Iodine
- 20.** Which one of the following four metals would be displaced from the solution of its salts by other three metals?
- Mg
 - Ag
 - Zn
 - Cu
- 21.** 2 mL each of concentrated HCl, HNO_3 and a mixture of concentrated HCl and concentrated HNO_3 in the ratio of 3 : 1 were taken in test tubes labelled as A, B and C. A small piece of metal was put in each test tube. No change occurred in test tubes A and B but the metal got dissolved in test tube C respectively. The metal could be
- Al
 - Au
 - Cu
 - Pt

- 22.** An alloy is
- (a) an element
 - (b) a compound
 - (c) a homogeneous mixture
 - (d) a heterogeneous mixture
- 23.** An electrolytic cell consists of
- (i) positively charged cathode
 - (ii) negatively charged anode
 - (iii) positively charged anode
 - (iv) negatively charged cathode
- (a) (i) and (ii) (b) (iii) and (iv)
(c) (i) and (iii) (d) (ii) and (iv)
- 24.** During electrolytic refining of zinc, it gets
- (a) deposited on cathode
 - (b) deposited on anode
 - (c) deposited on cathode as well as anode
 - (d) remains in the solution
- 25.** An element A is soft and can be cut with a knife. This is very reactive to air and cannot be kept open in air. It reacts vigorously with water. Identify the element from the following
- (a) Mg
 - (b) Na
 - (c) P
 - (d) Ca
- 26.** Alloys are homogeneous mixtures of a metal with a metal or non-metal. Which among the following alloys contain non-metal as one of its constituents?
- (a) Brass
 - (b) Bronze
 - (c) Amalgam
 - (d) Steel
- 27.** Which among the following statements is incorrect for magnesium metal?
- (a) It burns in oxygen with a dazzling white flame
 - (b) It reacts with cold water to form magnesium oxide and evolves hydrogen gas
 - (c) It reacts with hot water to form magnesium hydroxide and evolves hydrogen gas
 - (d) It reacts with steam to form magnesium hydroxide and evolves hydrogen gas

- 28.** Which among the following alloys contain mercury as one of its constituents?
- (a) Stainless steel
 - (b) Alnico
 - (c) Solder
 - (d) Zinc amalgam
- 29.** Reaction between X and Y, forms compound Z. X loses electron and Y gains electron. Which of the following properties is not shown by Z?
- (a) Has high melting point
 - (b) Has low melting point
 - (c) Conducts electricity in molten state
 - (d) Occurs as solid
- 30.** The electronic configurations of three elements X, Y and Z are X — 2, 8; Y — 2, 8, 7 and Z — 2, 8, 2. Which of the following is correct?
- (a) X is a metal
 - (b) Y is a metal
 - (c) Z is a non-metal
 - (d) Y is a non-metal and Z is a metal
- 31.** Although metals form basic oxides, which of the following metals form an amphoteric oxide?
- (a) Na
 - (b) Ca
 - (c) Al
 - (d) Cu
- 32.** Generally, non-metals are not conductors of electricity. Which of the following is a good conductor of electricity?
- (a) Diamond
 - (b) Graphite
 - (c) Sulphur
 - (d) Fullerene
- 33.** Electrical wires have a coating of an insulating material. The material, generally used is
- (a) Sulphur
 - (b) Graphite
 - (c) PVC
 - (d) All can be used

- 34.** Which of the following non-metals is a liquid?
 (a) Carbon
 (b) Bromine
 (c) Phosphorus
 (d) Sulphur
- 35.** Which of the following can undergo a chemical reaction?
 (a) $\text{MgSO}_4 + \text{Fe}$
 (b) $\text{ZnSO}_4 + \text{Fe}$
 (c) $\text{MgSO}_4 + \text{Pb}$
 (d) $\text{CuSO}_4 + \text{Fe}$
- 36.** Which one of the following figures correctly describes the process of electrolytic refining?

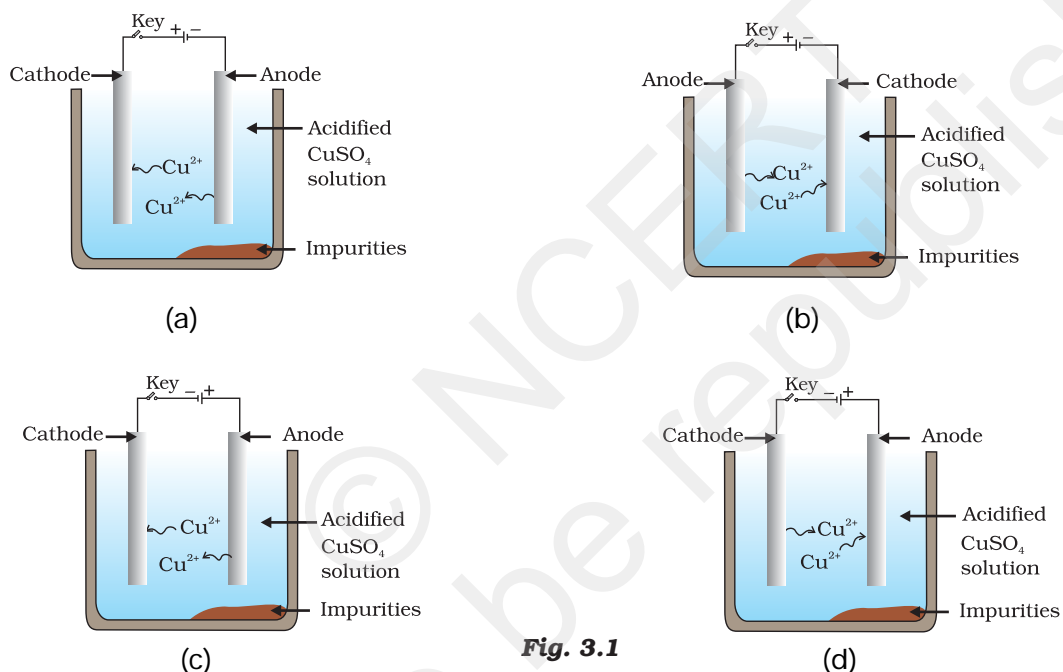

Fig. 3.1

Short Answer Questions

- 37.** Iqbal treated a lustrous, divalent element M with sodium hydroxide. He observed the formation of bubbles in reaction mixture. He made the same observations when this element was treated with hydrochloric acid. Suggest how can he identify the produced gas. Write chemical equations for both the reactions.
- 38.** During extraction of metals, electrolytic refining is used to obtain pure metals. (a) Which material will be used as anode and cathode for refining of silver metal by this process? (b) Suggest a suitable electrolyte also. (c) In this electrolytic cell, where do we get pure silver after passing electric current?

- 39.** Why should the metal sulphides and carbonates be converted to metal oxides in the process of extraction of metal from them?
- 40.** Generally, when metals are treated with mineral acids, hydrogen gas is liberated but when metals (except Mn and Mg), treated with HNO_3 , hydrogen is not liberated, why?
- 41.** Compound X and aluminium are used to join railway tracks. (a) Identify the compound X (b) Name the reaction (c) Write down its reaction.
- 42.** When a metal X is treated with cold water, it gives a basic salt Y with molecular formula XOH (Molecular mass = 40) and liberates a gas Z which easily catches fire. Identify X, Y and Z and also write the reaction involved.
- 43.** A non-metal X exists in two different forms Y and Z. Y is the hardest natural substance, whereas Z is a good conductor of electricity. Identify X, Y and Z.
- 44.** The following reaction takes place when aluminium powder is heated with MnO_2
- $$3 \text{MnO}_2(\text{s}) + 4 \text{Al}(\text{s}) \rightarrow 3 \text{Mn}(\text{l}) + 2 \text{Al}_2\text{O}_3(\text{l}) + \text{Heat}$$
- (a) Is aluminium getting reduced? (b) Is MnO_2 getting oxidised?
- 45.** What are the constituents of solder alloy? Which property of solder makes it suitable for welding electrical wires?
- 46.** A metal A, which is used in thermite process, when heated with oxygen gives an oxide B, which is amphoteric in nature. Identify A and B. Write down the reactions of oxide B with HCl and NaOH .
- 47.** A metal that exists as a liquid at room temperature is obtained by heating its sulphide in the presence of air. Identify the metal and its ore and give the reaction involved.
- 48.** Give the formulae of the stable binary compounds that would be formed by the combination of following pairs of elements.
- (a) Mg and N_2
(b) Li and O_2
(c) Al and Cl_2
(d) K and O_2
- 49.** What happens when
- (a) ZnCO_3 is heated in the absence of oxygen?
(b) a mixture of Cu_2O and Cu_2S is heated?

- 50.** A non-metal A is an important constituent of our food and forms two oxides B and C. Oxide B is toxic whereas C causes global warming
- Identify A, B and C
 - To which Group of Periodic Table does A belong?
- 51.** Give two examples each of the metals that are good conductors and poor conductors of heat respectively.
- 52.** Name one metal and one non-metal that exist in liquid state at room temperature. Also name two metals having melting point less than 310 K (37°C)
- 53.** An element A reacts with water to form a compound B which is used in white washing. The compound B on heating forms an oxide C which on treatment with water gives back B. Identify A, B and C and give the reactions involved.
- 54.** An alkali metal A gives a compound B (molecular mass = 40) on reacting with water. The compound B gives a soluble compound C on treatment with aluminium oxide. Identify A, B and C and give the reaction involved.
- 55.** Give the reaction involved during extraction of zinc from its ore by
- roasting of zinc ore
 - calcination of zinc ore
- 56.** A metal M does not liberate hydrogen from acids but reacts with oxygen to give a black colour product. Identify M and black coloured product and also explain the reaction of M with oxygen.
- 57.** An element forms an oxide A_2O_3 which is acidic in nature. Identify A as a metal or non-metal.
- 58.** A solution of $CuSO_4$ was kept in an iron pot. After few days the iron pot was found to have a number of holes in it. Explain the reason in terms of reactivity. Write the equation of the reaction involved.

Long Answer Questions

- 59.** A non-metal A which is the largest constituent of air, when heated with H_2 in 1:3 ratio in the presence of catalyst (Fe) gives a gas B. On heating with O_2 it gives an oxide C. If this oxide is passed into water in the presence of air it gives an acid D which acts as a strong oxidising agent.
- Identify A, B, C and D
 - To which group of periodic table does this non-metal belong?

- 60.** Give the steps involved in the extraction of metals of low and medium reactivity from their respective sulphide ores.
- 61.** Explain the following
- (a) Reactivity of Al decreases if it is dipped in HNO_3
 - (b) Carbon cannot reduce the oxides of Na or Mg
 - (c) NaCl is not a conductor of electricity in solid state whereas it does conduct electricity in aqueous solution as well as in molten state
 - (d) Iron articles are galvanised.
 - (e) Metals like Na, K, Ca and Mg are never found in their free state in nature.
- 62.** (i) Given below are the steps for extraction of copper from its ore. Write the reaction involved.
- (a) Roasting of copper (1) sulphide
 - (b) Reduction of copper (1) oxide with copper (1) sulphide.
 - (c) Electrolytic refining
- (ii) Draw a neat and well labelled diagram for electrolytic refining of copper
- 63.** Of the three metals X, Y and Z. X reacts with cold water, Y with hot water and Z with steam only. Identify X, Y and Z and also arrange them in order of increasing reactivity.
- 64.** An element A burns with golden flame in air. It reacts with another element B, atomic number 17 to give a product C. An aqueous solution of product C on electrolysis gives a compound D and liberates hydrogen. Identify A, B, C and D. Also write down the equations for the reactions involved.
- 65.** Two ores A and B were taken. On heating ore A gives CO_2 whereas, ore B gives SO_2 . What steps will you take to convert them into metals?

CHAPTER 4

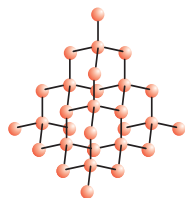

Carbon and its Compounds

Multiple Choice Questions

- Carbon exists in the atmosphere in the form of
 - carbon monoxide only
 - carbon monoxide in traces and carbon dioxide
 - carbon dioxide only
 - coal
- Which of the following statements are usually correct for carbon compounds? These
 - are good conductors of electricity
 - are poor conductors of electricity
 - have strong forces of attraction between their molecules
 - do not have strong forces of attraction between their molecules
 - (i) and (iii)
 - (ii) and (iii)
 - (i) and (iv)
 - (ii) and (iv)
- A molecule of ammonia (NH_3) has
 - only single bonds
 - only double bonds
 - only triple bonds
 - two double bonds and one single bond
- Buckminsterfullerene is an allotropic form of
 - phosphorus
 - sulphur
 - carbon
 - tin

5. Which of the following are correct structural isomers of butane?

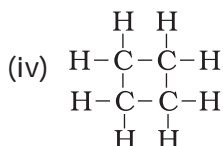
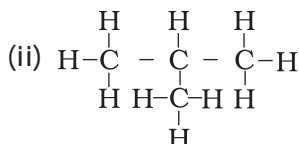
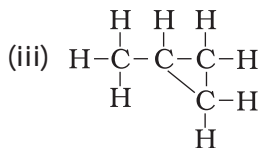
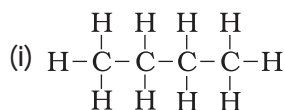

- (a) (i) and (iii) (b) (ii) and (iv)
(c) (i) and (ii) (d) (iii) and (iv)

6. $\text{CH}_3-\text{CH}_2-\text{OH} \xrightarrow{\text{Alkaline KMnO}_4 + \text{Heat}} \text{CH}_3-\text{COOH}$

In the above given reaction, alkaline KMnO_4 acts as

- (a) reducing agent
(b) oxidising agent
(c) catalyst
(d) dehydrating agent
7. Oils on treating with hydrogen in the presence of palladium or nickel catalyst form fats. This is an example of
- (a) Addition reaction
(b) Substitution reaction
(c) Displacement reaction
(d) Oxidation reaction
8. In which of the following compounds, — OH is the functional group?
- (a) Butanone
(b) Butanol
(c) Butanoic acid
(d) Butanal
9. The soap molecule has a
- (a) hydrophilic head and a hydrophobic tail
(b) hydrophobic head and a hydrophilic tail
(c) hydrophobic head and a hydrophobic tail
(d) hydrophilic head and a hydrophilic tail

10. Which of the following is the correct representation of electron dot structure of nitrogen?

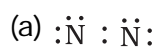

11. Structural formula of ethyne is

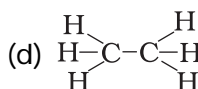
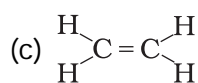
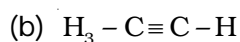
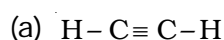

12. Identify the unsaturated compounds from the following

(i) Propane

(ii) Propene

(iii) Propyne

(iv) Chloropropane

(a) (i) and (ii)

(b) (ii) and (iv)

(c) (iii) and (iv)

(d) (ii) and (iii)

13. Chlorine reacts with saturated hydrocarbons at room temperature in the

(a) absence of sunlight

(b) presence of sunlight

(c) presence of water

(d) presence of hydrochloric acid

14. In the soap micelles

(a) the ionic end of soap is on the surface of the cluster while the carbon chain is in the interior of the cluster.

(b) ionic end of soap is in the interior of the cluster and the carbon chain is out of the cluster.

(c) both ionic end and carbon chain are in the interior of the cluster

(d) both ionic end and carbon chain are on the exterior of the cluster

15. Pentane has the molecular formula C_5H_{12} . It has

- (a) 5 covalent bonds
- (b) 12 covalent bonds
- (c) 16 covalent bonds
- (d) 17 covalent bonds

16. Structural formula of benzene is

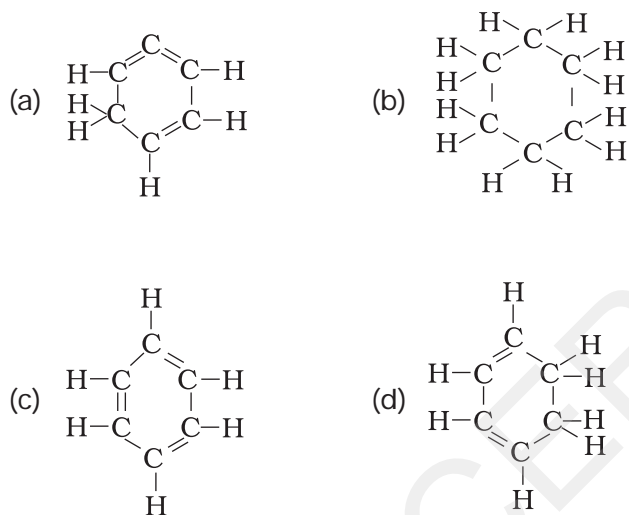

17. Ethanol reacts with sodium and forms two products. These are

- (a) sodium ethanoate and hydrogen
- (b) sodium ethanoate and oxygen
- (c) sodium ethoxide and hydrogen
- (d) sodium ethoxide and oxygen

18. The correct structural formula of butanoic acid is

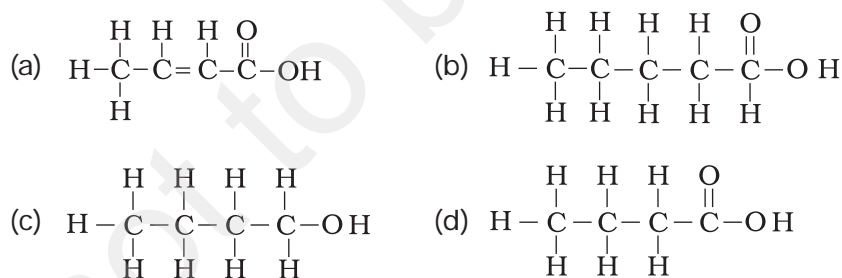

19. Vinegar is a solution of

- (a) 50% - 60% acetic acid in alcohol
- (b) 5% - 8% acetic acid in alcohol
- (c) 5% - 8% acetic acid in water
- (d) 50% - 60% acetic acid in water

- 20.** Mineral acids are stronger acids than carboxylic acids because
- mineral acids are completely ionised
 - carboxylic acids are completely ionised
 - mineral acids are partially ionised
 - carboxylic acids are partially ionised
- (i) and (iv)
 - (ii) and (iii)
 - (i) and (ii)
 - (iii) and (iv)
- 21.** Carbon forms four covalent bonds by sharing its four valence electrons with four univalent atoms, e.g. hydrogen. After the formation of four bonds, carbon attains the electronic configuration of
- helium
 - neon
 - argon
 - krypton
- 22.** The correct electron dot structure of a water molecule is
- $\text{H} \cdot \ddot{\text{O}} \cdot \text{H}$
 - $\text{H} : \ddot{\text{O}} : \text{H}$
 - $\text{H} : \ddot{\text{O}} : \text{H}$
 - $\text{H} : \text{O} : \text{H}$
- 23.** Which of the following is not a straight chain hydrocarbon?
- $\text{H}_3\text{C}-\text{CH}_2-\text{CH}_2-\text{CH}_2-\underset{\text{CH}_3}{\text{CH}_2}$
 - $\text{H}_3\text{C}-\text{CH}_2-\text{CH}_2-\text{CH}_2-\text{CH}_2-\text{CH}_3$
 - $\text{H}_2\overset{\text{CH}_3}{\text{C}}-\text{H}_2\text{C}-\text{H}_2\text{C}-\underset{\text{CH}_3}{\text{CH}_2}$
 - $\begin{matrix} \text{CH}_3 \\ \diagdown \\ \text{H}_3\text{C}-\text{CH}-\text{CH}_2-\text{CH}_2-\text{CH}_3 \end{matrix}$
- 24.** Which among the following are unsaturated hydrocarbons?
- $\text{H}_3\text{C}-\text{CH}_2-\text{CH}_2-\text{CH}_3$
 - $\text{H}_3\text{C}-\text{C}\equiv\text{C}-\text{CH}_3$
 - $\text{H}_3\text{C}-\underset{\text{CH}_3}{\text{CH}}-\text{CH}_3$
 - $\text{H}_3\text{C}-\underset{\text{CH}_3}{\text{C}}=\text{CH}_2$
- (i) and (iii)
 - (ii) and (iii)
 - (ii) and (iv)
 - (iii) and (iv)

- 25.** Which of the following does not belong to the same homologous series?
- (a) CH_4
 (b) C_2H_6
 (c) C_3H_8
 (d) C_4H_8
- 26.** The name of the compound $\text{CH}_3 - \text{CH}_2 - \text{CHO}$ is
- (a) Propanal
 (b) Propanone
 (c) Ethanol
 (d) Ethanal
- 27.** The heteroatoms present in $\text{CH}_3 - \text{CH}_2 - \text{O} - \text{CH}_2 - \text{CH}_2\text{Cl}$ are
- (i) oxygen
 (ii) carbon
 (iii) hydrogen
 (iv) chlorine
- (a) (i) and (ii) (b) (ii) and (iii)
 (c) (iii) and (iv) (d) (i) and (iv)
- 28.** Which of the following represents saponification reaction?
- (a) $\text{CH}_3\text{COONa} + \text{NaOH} \xrightarrow{\text{CaO}} \text{CH}_4 + \text{Na}_2\text{CO}_3$
 (b) $\text{CH}_3\text{COOH} + \text{C}_2\text{H}_5\text{OH} \xrightarrow{\text{H}_2\text{SO}_4} \text{CH}_3\text{COOC}_2\text{H}_5 + \text{H}_2\text{O}$
 (c) $2\text{CH}_3\text{COOH} + 2\text{Na} \rightarrow 2\text{CH}_3\text{COONa} + \text{H}_2$
 (d) $\text{CH}_3\text{COOC}_2\text{H}_5 + \text{NaOH} \rightarrow \text{CH}_3\text{COONa} + \text{C}_2\text{H}_5\text{OH}$
- 29.** The first member of alkyne homologous series is
- (a) ethyne
 (b) ethene
 (c) propyne
 (d) methane

Short Answer Questions

- 30.** Draw the electron dot structure of ethyne and also draw its structural formula

31. Write the names of the following compounds

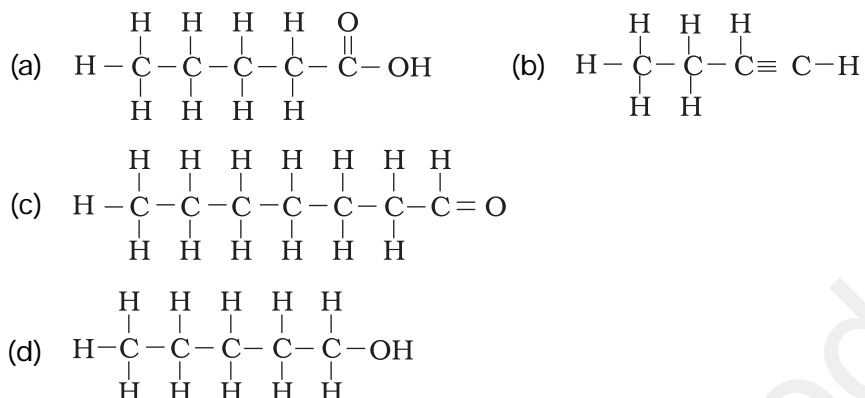

32. Identify and name the functional groups present in the following compounds.

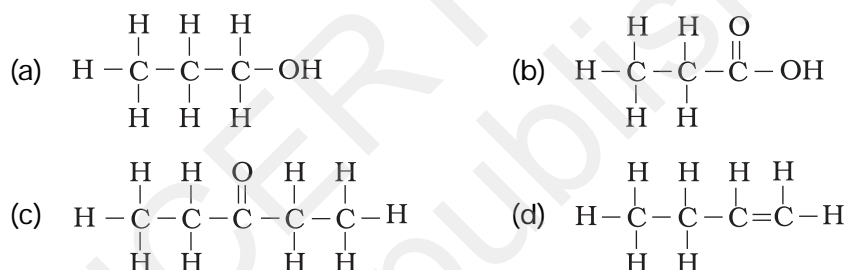

33. A compound X is formed by the reaction of a carboxylic acid $\text{C}_2\text{H}_4\text{O}_2$ and an alcohol in presence of a few drops of H_2SO_4 . The alcohol on oxidation with alkaline KMnO_4 followed by acidification gives the same carboxylic acid as used in this reaction. Give the names and structures of (a) carboxylic acid, (b) alcohol and (c) the compound X. Also write the reaction.

34. Why detergents are better cleansing agents than soaps? Explain.

35. Name the functional groups present in the following compounds

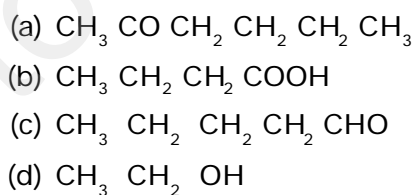

36. How is ethene prepared from ethanol? Give the reaction involved in it.

37. Intake of small quantity of methanol can be lethal. Comment.

- 38.** A gas is evolved when ethanol reacts with sodium. Name the gas evolved and also write the balanced chemical equation of the reaction involved.
- 39.** Ethene is formed when ethanol at 443 K is heated with excess of concentrated sulphuric acid. What is the role of sulphuric acid in this reaction? Write the balanced chemical equation of this reaction.
- 40.** Carbon, Group (14) element in the Periodic Table, is known to form compounds with many elements.
Write an example of a compound formed with
- (a) chlorine (Group 17 of Periodic Table)
(b) oxygen (Group 16 of Periodic Table)
- 41.** In electron dot structure, the valence shell electrons are represented by crosses or dots.
- (a) The atomic number of chlorine is 17. Write its electronic configuration
(b) Draw the electron dot structure of chlorine molecule.
- 42.** Catenation is the ability of an atom to form bonds with other atoms of the same element. It is exhibited by both carbon and silicon. Compare the ability of catenation of the two elements. Give reasons.
- 43.** Unsaturated hydrocarbons contain multiple bonds between the two C-atoms and show addition reactions. Give the test to distinguish ethane from ethene.
- 44.** Match the reactions given in Column (A) with the names given in column (B).

Column (A)	Column (B)
(a) $\text{CH}_3\text{OH} + \text{CH}_3\text{COOH} \xrightarrow{\text{H}^+} \text{CH}_3\text{COOCH}_3 + \text{H}_2\text{O}$	(i) Addition reaction
(b) $\text{CH}_2 = \text{CH}_2 + \text{H}_2 \xrightarrow{\text{Ni}} \text{CH}_3 - \text{CH}_3$	(ii) Substitution reaction
(c) $\text{CH}_4 + \text{Cl}_2 \xrightarrow{\text{Sunlight}} \text{CH}_3\text{Cl} + \text{HCl}$	(iii) Neutralisation reaction
(d) $\text{CH}_3\text{COOH} + \text{NaOH} \longrightarrow \text{CH}_3\text{COONa} + \text{H}_2\text{O}$	(iv) Esterification reaction

- 45.** Write the structural formulae of all the isomers of hexane.
- 46.** What is the role of metal or reagents written on arrows in the given chemical reactions?

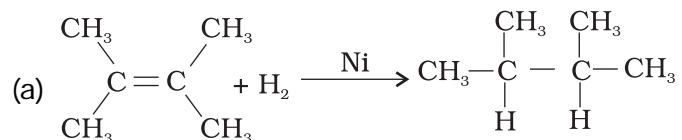

Long Answer Questions

- 47.** A salt X is formed and a gas is evolved when ethanoic acid reacts with sodium hydrogencarbonate. Name the salt X and the gas evolved. Describe an activity and draw the diagram of the apparatus to prove that the evolved gas is the one which you have named. Also, write chemical equation of the reaction involved.
- 48.** (a) What are hydrocarbons? Give examples.
 (b) Give the structural differences between saturated and unsaturated hydrocarbons with two examples each.
 (c) What is a functional group? Give examples of four different functional groups.
- 49.** Name the reaction which is commonly used in the conversion of vegetable oils to fats. Explain the reaction involved in detail.
- 50.** (a) Write the formula and draw electron dot structure of carbon tetrachloride.
 (b) What is saponification? Write the reaction involved in this process.
- 51.** Esters are sweet-smelling substances and are used in making perfumes. Suggest some activity and the reaction involved for the preparation of an ester with well labeled diagram.
- 52.** A compound C (molecular formula, $\text{C}_2\text{H}_4\text{O}_2$) reacts with Na - metal to form a compound R and evolves a gas which burns with a pop sound. Compound C on treatment with an alcohol A in presence of an acid forms a sweet smelling compound S (molecular formula, $\text{C}_3\text{H}_6\text{O}_2$). On addition of NaOH to C, it also gives R and water. S on treatment with NaOH solution gives back R and A.
 Identify C, R, A, S and write down the reactions involved.

53. Look at Figure 4.1 and answer the following questions

- What change would you observe in the calcium hydroxide solution taken in tube B?
- Write the reaction involved in test tubes A and B respectively.
- If ethanol is given instead of ethanoic acid, would you expect the same change?
- How can a solution of lime water be prepared in the laboratory?

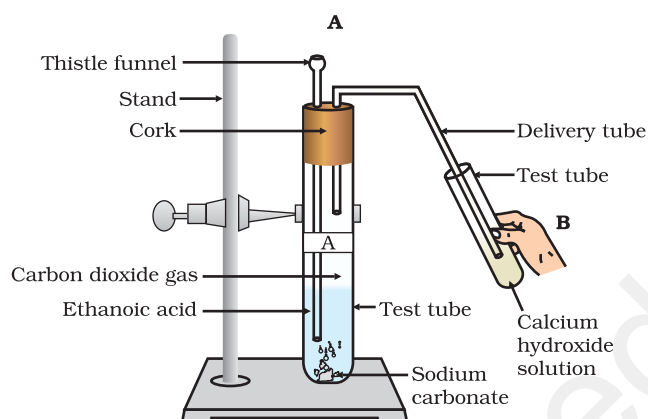

Fig. 4.1

54. How would you bring about the following conversions? Name the process and write the reaction involved.

- ethanol to ethene.
- propanol to propanoic acid.

Write the reactions.

55. Draw the possible isomers of the compound with molecular formula C_3H_6O and also give their electron dot structures.

56. Explain the given reactions with the examples

- Hydrogenation reaction
- Oxidation reaction
- Substitution reaction
- Saponification reaction
- Combustion reaction

57. An organic compound A on heating with concentrated H_2SO_4 forms a compound B which on addition of one mole of hydrogen in presence of Ni forms a compound C. One mole of compound C on combustion forms two moles of CO_2 and 3 moles of H_2O . Identify the compounds A, B and C and write the chemical equations of the reactions involved.



CHAPTER 5

Periodic Classification of Elements

Multiple Choice Questions

- Upto which element, the Law of Octaves was found to be applicable
 - Oxygen
 - Calcium
 - Cobalt
 - Potassium
- According to Mendeléeev's Periodic Law, the elements were arranged in the periodic table in the order of
 - increasing atomic number
 - decreasing atomic number
 - increasing atomic masses
 - decreasing atomic masses
- In Mendeléeev's Periodic Table, gaps were left for the elements to be discovered later. Which of the following elements found a place in the periodic table later
 - Germanium
 - Chlorine
 - Oxygen
 - Silicon
- Which of the following statement (s) about the Modern Periodic Table are incorrect
 - The elements in the Modern Periodic Table are arranged on the basis of their decreasing atomic number
 - The elements in the Modern Periodic Table are arranged on the basis of their increasing atomic masses
 - Isotopes are placed in adjoining group (s) in the Periodic Table
 - The elements in the Modern Periodic Table are arranged on the basis of their increasing atomic number
 - (i) only
 - (i), (ii) and (iii)
 - (i), (ii) and (iv)
 - (iv) only

5. Which of the following statements about the Modern Periodic Table is correct:
- (a) It has 18 horizontal rows known as Periods
 - (b) It has 7 vertical columns known as Periods
 - (c) It has 18 vertical columns known as Groups
 - (d) It has 7 horizontal rows known as Groups
6. Which of the given elements A, B, C, D and E with atomic number 2, 3, 7, 10 and 30 respectively belong to the same period?
- (a) A, B, C
 - (b) B, C, D
 - (c) A, D, E
 - (d) B, D, E
7. The elements A, B, C, D and E have atomic number 9, 11, 17, 12 and 13 respectively. Which pair of elements belong to the same group?
- (a) A and B
 - (b) B and D
 - (c) A and C
 - (d) D and E
8. Where would you locate the element with electronic configuration 2,8 in the Modern Periodic Table?
- (a) Group 8
 - (b) Group 2
 - (c) Group 18
 - (d) Group 10
9. An element which is an essential constituent of all organic compounds belongs to
- (a) group 1
 - (b) group 14
 - (c) group 15
 - (d) group 16
10. Which of the following is the outermost shell for elements of period 2?
- (a) K shell
 - (b) L shell
 - (c) M shell
 - (d) N shell

- 11.** Which one of the following elements exhibit maximum number of valence electrons?
- (a) Na
 - (b) Al
 - (c) Si
 - (d) P
- 12.** Which of the following gives the correct increasing order of the atomic radii of O, F and N ?
- (a) O, F, N
 - (b) N, F, O
 - (c) O, N, F
 - (d) F, O, N
- 13.** Which among the following elements has the largest atomic radii?
- (a) Na
 - (b) Mg
 - (c) K
 - (d) Ca
- 14.** Which of the following elements would lose an electron easily?
- (a) Mg
 - (b) Na
 - (c) K
 - (d) Ca
- 15.** Which of the following elements does not lose an electron easily?
- (a) Na
 - (b) F
 - (c) Mg
 - (d) Al
- 16.** Which of the following are the characteristics of isotopes of an element?
- (i) Isotopes of an element have same atomic masses
 - (ii) Isotopes of an element have same atomic number
 - (iii) Isotopes of an element show same physical properties
 - (iv) Isotopes of an element show same chemical properties
- (a) (i), (iii) and (iv) (b) (ii), (iii) and (iv)
(c) (ii) and (iii) (d) (ii) and (iv)

17. Arrange the following elements in the order of their decreasing metallic character

Na, Si, Cl, Mg, Al

- (a) $\text{Cl} > \text{Si} > \text{Al} > \text{Mg} > \text{Na}$
- (b) $\text{Na} > \text{Mg} > \text{Al} > \text{Si} > \text{Cl}$
- (c) $\text{Na} > \text{Al} > \text{Mg} > \text{Cl} > \text{Si}$
- (d) $\text{Al} > \text{Na} > \text{Si} > \text{Ca} > \text{Mg}$

18. Arrange the following elements in the order of their increasing non-metallic character

Li, O, C, Be, F

- (a) $\text{F} < \text{O} < \text{C} < \text{Be} < \text{Li}$
- (b) $\text{Li} < \text{Be} < \text{C} < \text{O} < \text{F}$
- (c) $\text{F} < \text{O} < \text{C} < \text{Be} < \text{Li}$
- (d) $\text{F} < \text{O} < \text{Be} < \text{C} < \text{Li}$

19. What type of oxide would Eka- aluminium form?

- (a) EO_3
- (b) E_3O_2
- (c) E_2O_3
- (d) EO

20. Three elements B, Si and Ge are

- (a) metals
- (b) non-metals
- (c) metalloids
- (d) metal, non-metal and metalloid respectively

21. Which of the following elements will form an acidic oxide?

- (a) An element with atomic number 7
- (b) An element with atomic number 3
- (c) An element with atomic number 12
- (d) An element with atomic number 19

22. The element with atomic number 14 is hard and forms acidic oxide and a covalent halide. To which of the following categories does the element belong?

- (a) Metal
- (b) Metalloid
- (c) Non-metal
- (d) Left-hand side element

23. Which one of the following depict the correct representation of atomic radius(r) of an atom?

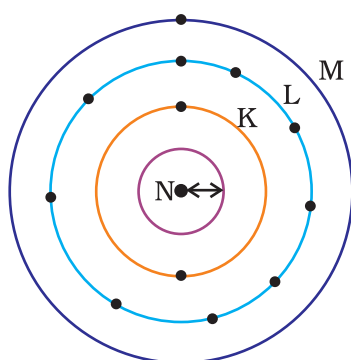

(i)

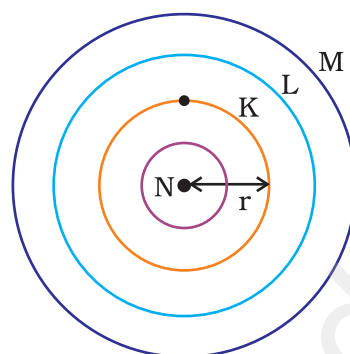

(ii)

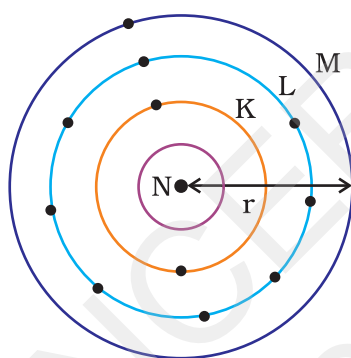

(iii)

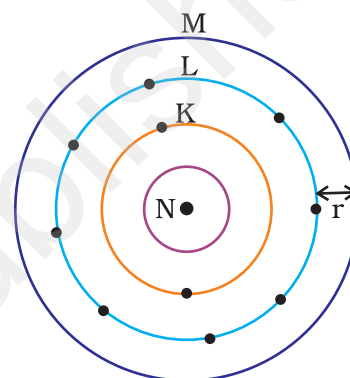

(iv)

- (a) (i) and (ii) (b) (ii) and (iii)
 (c) (iii) and (iv) (d) (i) and (iv)

24. Which one of the following does not increase while moving down the group of the periodic table?

- (a) Atomic radius
 (b) Metallic character
 (c) Valence
 (d) Number of shells in an element

25. On moving from left to right in a period in the periodic table, the size of the atom.

- (a) increases
 (b) decreases
 (c) does not change appreciably
 (d) first decreases and then increases

- 26.** Which of the following set of elements is written in order of their increasing metallic character?
- (a) Be Mg Ca
 - (b) Na Li K
 - (c) Mg Al Si
 - (d) C O N

Short Answer Questions

- 27.** The three elements A, B and C with similar properties have atomic masses X, Y and Z respectively. The mass of Y is approximately equal to the average mass of X and Z. What is such an arrangement of elements called as? Give one example of such a set of elements.
- 28.** Elements have been arranged in the following sequence on the basis of their increasing atomic masses.
F, Na, Mg, Al, Si, P, S, Cl, Ar, K
- (a) Pick two sets of elements which have similar properties.
 - (b) The given sequence represents which law of classification of elements?
- 29.** Can the following groups of elements be classified as Döbereiner's triad ?
- (a) Na, Si, Cl
 - (b) Be, Mg, Ca
- Atomic mass of Be 9; Na 23; Mg 24; Si 28; Cl 35; Ca 40
Explain by giving reason.
- 30.** In Mendeléeev's Periodic Table the elements were arranged in the increasing order of their atomic masses. However, cobalt with atomic mass of 58.93 amu was placed before nickel having an atomic mass of 58.71 amu. Give reason for the same.
- 31.** "Hydrogen occupies a unique position in Modern Periodic Table". Justify the statement.
- 32.** Write the formulae of chlorides of Eka-silicon and Eka-aluminium, the elements predicted by Mendeléeev.
- 33.** Three elements A, B and C have 3, 4 and 2 electrons respectively in their outermost shell. Give the group number to which they belong in the Modern Periodic Table. Also, give their valencies.

- 34.** If an element X is placed in group 14, what will be the formula and the nature of bonding of its chloride?
- 35.** Compare the radii of two species X and Y. Give reasons for your answer.
- (a) X has 12 protons and 12 electrons
 - (b) Y has 12 protons and 10 electrons
- 36.** Arrange the following elements in increasing order of their atomic radii.
- (a) Li, Be, F, N
 - (b) Cl, At, Br, I
- 37.** Identify and name the metals out of the following elements whose electronic configurations are given below.
- (a) 2, 8, 2
 - (b) 2, 8, 1
 - (c) 2, 8, 7
 - (d) 2, 1
- 38.** Write the formula of the product formed when the element A (atomic number 19) combines with the element B (atomic number 17). Draw its electronic dot structure. What is the nature of the bond formed?
- 39.** Arrange the following elements in the increasing order of their metallic character
- Mg, Ca, K, Ge, Ga
- 40.** Identify the elements with the following property and arrange them in increasing order of their reactivity
- (a) An element which is a soft and reactive metal
 - (b) The metal which is an important constituent of limestone
 - (c) The metal which exists in liquid state at room temperature
- 41.** Properties of the elements are given below. Where would you locate the following elements in the periodic table?
- (a) A soft metal stored under kerosene
 - (b) An element with variable (more than one) valency stored under water.
 - (c) An element which is tetravalent and forms the basis of organic chemistry
 - (d) An element which is an inert gas with atomic number 2
 - (e) An element whose thin oxide layer is used to make other elements corrosion resistant by the process of "anodising"

Long Answer Questions

- 42.** An element is placed in 2nd Group and 3rd Period of the Periodic Table, burns in presence of oxygen to form a basic oxide.
- Identify the element
 - Write the electronic configuration
 - Write the balanced equation when it burns in the presence of air
 - Write a balanced equation when this oxide is dissolved in water
 - Draw the electron dot structure for the formation of this oxide
- 43.** An element X (atomic number 17) reacts with an element Y (atomic number 20) to form a divalent halide.
- Where in the periodic table are elements X and Y placed?
 - Classify X and Y as metal (s), non-metal (s) or metalloid (s)
 - What will be the nature of oxide of element Y? Identify the nature of bonding in the compound formed
 - Draw the electron dot structure of the divalent halide
- 44.** Atomic number of a few elements are given below
10, 20, 7, 14
- Identify the elements
 - Identify the Group number of these elements in the Periodic Table
 - Identify the Periods of these elements in the Periodic Table
 - What would be the electronic configuration for each of these elements?
 - Determine the valency of these elements
- 45.** Complete the following cross word puzzle (Figure 5.1)

Across:

- An element with atomic number 12.
- Metal used in making cans and member of Group 14.
- A lustrous non-metal which has 7 electrons in its outermost shell.

Down:

- Highly reactive and soft metal which imparts yellow colour when subjected to flame and is kept in kerosene.

	1	7				2						
		3	8			9		5				
						4				6		

Fig. 5.1

- (5) The first element of second Period
 - (6) An element which is used in making fluorescent bulbs and is second member of Group 18 in the Modern Periodic Table
 - (7) A radioactive element which is the last member of halogen family.
 - (8) Metal which is an important constituent of steel and forms rust when exposed to moist air.
 - (9) The first metalloid in Modern Periodic Table whose fibres are used in making bullet-proof vests
- 46.** (a) In this ladder (Figure 5.2) symbols of elements are jumbled up. Rearrange these symbols of elements in the increasing order of their atomic number in the Periodic Table.
- (b) Arrange them in the order of their group also.

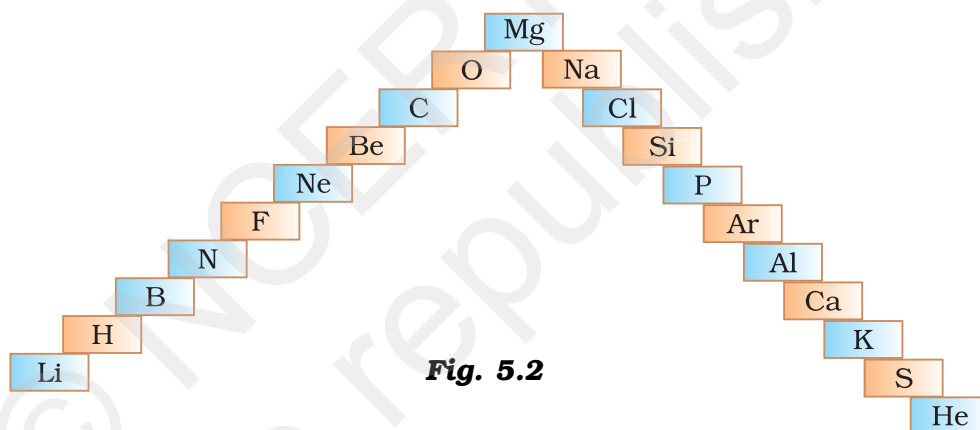

- 47.** Mendeléeev predicted the existence of certain elements not known at that time and named two of them as Eka-silicon and Eka-aluminium.
- (a) Name the elements which have taken the place of these elements
 - (b) Mention the group and the period of these elements in the Modern Periodic Table.
 - (c) Classify these elements as metals, non-metals or metalloids
 - (d) How many valence electrons are present in each one of them?
- 48.** (a) Electropositive nature of the element(s) increases down the group and decreases across the period
- (b) Electronegativity of the element decreases down the group and increases across the period
- (c) Atomic size increases down the group and decreases across a period (left to right)
- (d) Metallic character increases down the group and decreases across a period.

On the basis of the above trends of the Periodic Table, answer the following about the elements with atomic numbers 3 to 9.

- (a) Name the most electropositive element among them
 - (b) Name the most electronegative element
 - (c) Name the element with smallest atomic size
 - (d) Name the element which is a metalloid
 - (e) Name the element which shows maximum valency.
- 49.** An element X which is a yellow solid at room temperature shows catenation and allotropy. X forms two oxides which are also formed during the thermal decomposition of ferrous sulphate crystals and are the major air pollutants.
- (a) Identify the element X
 - (b) Write the electronic configuration of X
 - (c) Write the balanced chemical equation for the thermal decomposition of ferrous sulphate crystals?
 - (d) What would be the nature (acidic/ basic) of oxides formed?
 - (e) Locate the position of the element in the Modern Periodic Table.
- 50.** An element X of group 15 exists as diatomic molecule and combines with hydrogen at 773 K in presence of the catalyst to form a compound, ammonia which has a characteristic pungent smell.
- (a) Identify the element X. How many valence electrons does it have?
 - (b) Draw the electron dot structure of the diatomic molecule of X. What type of bond is formed in it?
 - (c) Draw the electron dot structure for ammonia and what type of bond is formed in it?
- 51.** Which group of elements could be placed in Mendeléeev's Periodic Table without disturbing the original order? Give reason.
- 52.** Give an account of the process adopted by Mendeléeev for the classification of elements. How did he arrive at "Periodic Law"?

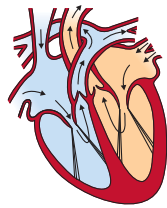

CHAPTER 6

Life Processes

Multiple Choice Questions

- Which of the following statements about the autotrophs is incorrect?
 - They synthesise carbohydrates from carbon dioxide and water in the presence of sunlight and chlorophyll
 - They store carbohydrates in the form of starch
 - They convert carbon dioxide and water into carbohydrates in the absence of sunlight
 - They constitute the first trophic level in food chains
- In which of the following groups of organisms, food material is broken down outside the body and absorbed?
 - Mushroom, green plants, **Amoeba**
 - Yeast, mushroom, bread mould
 - Paramecium, Amoeba**, Cuscuta
 - Cuscuta, lice, tapeworm
- Select the correct statement
 - Heterotrophs do not synthesise their own food
 - Heterotrophs utilise solar energy for photosynthesis
 - Heterotrophs synthesise their own food
 - Heterotrophs are capable of converting carbon dioxide and water into carbohydrates
- Which is the correct sequence of parts in human alimentary canal?
 - Mouth → stomach → small intestine → oesophagus → large intestine
 - Mouth → oesophagus → stomach → large intestine → small intestine
 - Mouth → stomach → oesophagus → small intestine → large intestine
 - Mouth → oesophagus → stomach → small intestine → large intestine

5. If salivary amylase is lacking in the saliva, which of the following events in the mouth cavity will be affected?
- (a) Proteins breaking down into amino acids
 - (b) Starch breaking down into sugars
 - (c) Fats breaking down into fatty acids and glycerol
 - (d) Absorption of vitamins
6. The inner lining of stomach is protected by one of the following from hydrochloric acid. Choose the correct one
- (a) Pepsin
 - (b) Mucus
 - (c) Salivary amylase
 - (d) Bile
7. Which part of alimentary canal receives bile from the liver?
- (a) Stomach
 - (b) Small intestine
 - (c) Large intestine
 - (d) Oesophagus
8. A few drops of iodine solution were added to rice water. The solution turned blue-black in colour. This indicates that rice water contains
- (a) complex proteins
 - (b) simple proteins
 - (c) fats
 - (d) starch
9. In which part of the alimentary canal food is finally digested?
- (a) Stomach
 - (b) Mouth cavity
 - (c) Large intestine
 - (d) Small intestine
10. Choose the function of the pancreatic juice from the following
- (a) trypsin digests proteins and lipase carbohydrates
 - (b) trypsin digests emulsified fats and lipase proteins
 - (c) trypsin and lipase digest fats
 - (d) trypsin digests proteins and lipase emulsified fats
11. When air is blown from mouth into a test-tube containing lime water, the lime water turned milky due to the presence of
- (a) oxygen
 - (b) carbon dioxide
 - (c) nitrogen
 - (d) water vapour

- 12.** The correct sequence of anaerobic reactions in yeast is
- (a) Glucose cytoplasm → Pyruvate mitochondria → Ethanol + Carbondioxide
 - (b) Glucose cytoplasm → Pyruvate cytoplasm → Lactic acid
 - (c) Glucose cytoplasm → Pyruvate mitochondria → Lactic acid
 - (d) Glucose cytoplasm → Pyruvate cytoplasm → Ethanol + Carbondioxide
- 13.** Which of the following is most appropriate for aerobic respiration?
- (a) Glucose mitochondria → Pyruvate cytoplasm → $\text{CO}_2 + \text{H}_2\text{O} + \text{Energy}$
 - (b) Glucose cytoplasm → Pyruvate mitochondria → $\text{CO}_2 + \text{H}_2\text{O} + \text{Energy}$
 - (c) Glucose cytoplasm → Pyruvate + Energy mitochondria → $\text{CO}_2 + \text{H}_2\text{O}$
 - (d) Glucose cytoplasm → Pyruvate + Energy mitochondria → $\text{CO}_2 + \text{H}_2\text{O} + \text{Energy}$
- 14.** Which of the following statement(s) is (are) true about respiration?
- (i) During inhalation, ribs move inward and diaphragm is raised
 - (ii) In the alveoli, exchange of gases takes place i.e., oxygen from alveolar air diffuses into blood and carbon dioxide from blood into alveolar air
 - (iii) Haemoglobin has greater affinity for carbon dioxide than oxygen
 - (iv) Alveoli increase surface area for exchange of gases
- (a) (i) and (iv) (b) (ii) and (iii)
(c) (i) and (iii) (d) (ii) and (iv)
- 15.** Which is the correct sequence of air passage during inhalation?
- (a) Nostrils → larynx → pharynx → trachea → lungs
 - (b) Nasal passage → trachea → pharynx → larynx → alveoli
 - (c) larynx → nostrils → pharynx → lungs
 - (d) Nostrils → pharynx → larynx → trachea → alveoli
- 16.** During respiration exchange of gases take place in
- (a) trachea and larynx
 - (b) alveoli of lungs
 - (c) alveoli and throat
 - (d) throat and larynx

- 17.** Which of the following statement (s) is (are) true about heart?
- (i) Left atrium receives oxygenated blood from different parts of body while right atrium receives deoxygenated blood from lungs
 - (ii) Left ventricle pumps oxygenated blood to different body parts while right ventricle pumps deoxygenated blood to lungs
 - (iii) Left atrium transfers oxygenated blood to right ventricle which sends it to different body parts
 - (iv) Right atrium receives deoxygenated blood from different parts of the body while left ventricle pumps oxygenated blood to different parts of the body
- (a) (i) (b) (ii)
(c) (ii) and (iv) (d) (i) and (iii)
- 18.** What prevents backflow of blood inside the heart during contraction?
- (a) Valves in heart
 - (b) Thick muscular walls of ventricles
 - (c) Thin walls of atria
 - (d) All of the above
- 19.** Single circulation i.e., blood flows through the heart only once during one cycle of passage through the body, is exhibited by
- (a) Labeo, Chameleon, Salamander
 - (b) Hippocampus, Exocoetus, Anabas
 - (c) Hyla, Rana, Draco
 - (d) Whale, Dolphin, Turtle
- 20.** In which of the following vertebrate group/groups, heart does not pump oxygenated blood to different parts of the body?
- (a) Pisces and amphibians
 - (b) Amphibians and reptiles
 - (c) Amphibians only
 - (d) Pisces only
- 21.** Choose the correct statement that describes arteries.
- (a) They have thick elastic walls, blood flows under high pressure; collect blood from different organs and bring it back to the heart
 - (b) They have thin walls with valves inside, blood flows under low pressure and carry blood away from the heart to various organs of the body
 - (c) They have thick elastic walls, blood flows under low pressure; carry blood from the heart to various organs of the body
 - (d) They have thick elastic walls without valves inside, blood flows under high pressure and carry blood away from the heart to different parts of the body.

- 22.** The filtration units of kidneys are called
- (a) ureter
 - (b) urethra
 - (c) neurons
 - (d) nephrons
- 23.** Oxygen liberated during photosynthesis comes from
- (a) water
 - (b) chlorophyll
 - (c) carbon dioxide
 - (d) glucose
- 24.** The blood leaving the tissues becomes richer in
- (a) carbon dioxide
 - (b) water
 - (c) haemoglobin
 - (d) oxygen
- 25.** Which of the following is an incorrect statement?
- (a) Organisms grow with time
 - (b) Organisms must repair and maintain their structure
 - (c) Movement of molecules does not take place among cells
 - (d) Energy is essential for life processes
- 26.** The internal (cellular) energy reserve in autotrophs is
- (a) glycogen
 - (b) protein
 - (c) starch
 - (d) fatty acid
- 27.** Which of the following equations is the summary of photosynthesis?
- (a) $6\text{CO}_2 + 12\text{H}_2\text{O} \rightarrow \text{C}_6\text{H}_{12}\text{O}_6 + 6\text{O}_2 + 6\text{H}_2\text{O}$
 - (b) $6\text{CO}_2 + \text{H}_2\text{O} + \text{Sunlight} \rightarrow \text{C}_6\text{H}_{12}\text{O}_6 + \text{O}_2 + 6\text{H}_2\text{O}$
 - (c) $6\text{CO}_2 + 12\text{H}_2\text{O} + \text{Chlorophyll} + \text{Sunlight} \rightarrow \text{C}_6\text{H}_{12}\text{O}_6 + 6\text{O}_2 + 6\text{H}_2\text{O}$
 - (d) $6\text{CO}_2 + 12\text{H}_2\text{O} + \text{Chlorophyll} + \text{Sunlight} \rightarrow \text{C}_6\text{H}_{12}\text{O}_6 + 6\text{CO}_2 + 6\text{H}_2\text{O}$
- 28.** Choose the event that does not occur in photosynthesis
- (a) Absorption of light energy by chlorophyll
 - (b) Reduction of carbon dioxide to carbohydrates
 - (c) Oxidation of carbon to carbon dioxide
 - (d) Conversion of light energy to chemical energy

- 29.** The opening and closing of the stomatal pore depends upon
- (a) oxygen
 - (b) temperature
 - (c) water in guard cells
 - (d) concentration of CO₂ in stomata
- 30.** Choose the forms in which most plants absorb nitrogen
- (i) Proteins
 - (ii) Nitrates and Nitrites
 - (iii) Urea
 - (iv) Atmospheric nitrogen
- (a) (i) and (ii) (b) (ii) and (iii)
(c) (iii) and (iv) (d) (i) and (iv)
- 31.** Which is the first enzyme to mix with food in the digestive tract?
- (a) Pepsin
 - (b) Cellulase
 - (c) Amylase
 - (d) Trypsin
- 32.** Which of the following statement(s) is (are) correct?
- (i) Pyruvate can be converted into ethanol and carbon dioxide by yeast
 - (ii) Fermentation takes place in aerobic bacteria
 - (iii) Fermentation takes place in mitochondria
 - (iv) Fermentation is a form of anaerobic respiration
- (a) (i) and (iii) (b) (ii) and (iv)
(c) (i) and (iv) (d) (ii) and (iii)
- 33.** Lack of oxygen in muscles often leads to cramps among cricketers. This results due to
- (a) conversion of pyruvate to ethanol
 - (b) conversion of pyruvate to glucose
 - (c) non conversion of glucose to pyruvate
 - (d) conversion of pyruvate to lactic acid
- 34.** Choose the correct path of urine in our body
- (a) kidney → ureter → urethra → urinary bladder
 - (b) kidney → urinary bladder → urethra → ureter
 - (c) kidney → ureters → urinary bladder → urethra
 - (d) urinary bladder → kidney → ureter → urethra

- 35.** During deficiency of oxygen in tissues of human beings, pyruvic acid is converted into lactic acid in the
- (a) cytoplasm
 - (b) chloroplast
 - (c) mitochondria
 - (d) golgi body

Short Answer Questions

- 36.** Name the following
- (a) The process in plants that links light energy with chemical energy
 - (b) Organisms that can prepare their own food
 - (c) The cell organelle where photosynthesis occurs
 - (d) Cells that surround a stomatal pore
 - (e) Organisms that cannot prepare their own food
 - (f) An enzyme secreted from gastric glands in stomach that acts on proteins.
- 37.** "All plants give out oxygen during day and carbon dioxide during night". Do you agree with this statement? Give reason.
- 38.** How do the guard cells regulate opening and closing of stomatal pores?
- 39.** Two green plants are kept separately in oxygen free containers, one in the dark and the other in continuous light. Which one will live longer? Give reasons.
- 40.** If a plant is releasing carbon dioxide and taking in oxygen during the day, does it mean that there is no photosynthesis occurring? Justify your answer.
- 41.** Why do fishes die when taken out of water?
- 42.** Differentiate between an autotroph and a heterotroph.
- 43.** Is 'nutrition' a necessity for an organism? Discuss.
- 44.** What would happen if green plants disappear from earth?
- 45.** Leaves of a healthy potted plant were coated with vaseline. Will this plant remain healthy for long? Give reasons for your answer.
- 46.** How does aerobic respiration differ from anaerobic respiration?

47. Match the words of Column (A) with that of Column (B)

Column (A)	Column (B)
(a) Phloem	(i) Excretion
(b) Nephron	(ii) Translocation of food
(c) Veins	(iii) Clotting of blood
(d) Platelets	(iv) Deoxygenated blood

48. Differentiate between an artery and a vein.
49. What are the adaptations of leaf for photosynthesis?
50. Why is small intestine in herbivores longer than in carnivores?
51. What will happen if mucus is not secreted by the gastric glands?
52. What is the significance of emulsification of fats?
53. What causes movement of food inside the alimentary canal?
54. Why does absorption of digested food occur mainly in the small intestine?
55. Match Group (A) with Group (B)

Group (A)	Group (B)
(a) Autotrophic nutrition	(i) Leech
(b) Heterotrophic nutrition	(ii) Paramecium
(c) Parasitic nutrition	(iii) Deer
(d) Digestion in food vacuoles	(iv) Green plant

56. Why is the rate of breathing in aquatic organisms much faster than in terrestrial organisms?
57. Why is blood circulation in human heart called double circulation?
58. What is the advantage of having four chambered heart?
59. Mention the major events during photosynthesis
60. In each of the following situations what happens to the rate of photosynthesis?
- (a) Cloudy days
 - (b) No rainfall in the area
 - (c) Good manuring in the area
 - (d) Stomata get blocked due to dust
61. Name the energy currency in the living organisms. When and where is it produced?

62. What is common for cuscuta, ticks and leeches?
63. Explain the role of mouth in digestion of food.
64. What are the functions of gastric glands present in the wall of the stomach?
65. Match the terms in Column (A) with those in Column (B)

Column (A)	Group (B)
(a) Trypsin	(i) Pancreas
(b) Amylase	(ii) Liver
(c) Bile	(iii) Gastric glands
(d) Pepsin	(iv) Saliva

66. Name the correct substrates for the following enzymes
- (a) Trypsin (b) Amylase
(c) Pepsin (d) Lipase
67. Why do veins have thin walls as compared to arteries?
68. What will happen if platelets were absent in the blood?
69. Plants have low energy needs as compared to animals. Explain.
70. Why and how does water enter continuously into the root xylem?
71. Why is transpiration important for plants?
72. How do leaves of plants help in excretion?

Long Answer Questions

73. Explain the process of nutrition in *Amoeba*.
74. Describe the alimentary canal of man.
75. Explain the process of breathing in man.
76. Explain the importance of soil for plant growth.
77. Draw the diagram of alimentary canal of man and label the following parts.
Mouth, Oesophagus, Stomach, Intestine
78. How do carbohydrates, proteins and fats get digested in human beings?
79. Explain the mechanism of photosynthesis.
80. Explain the three pathways of breakdown in living organisms.
81. Describe the flow of blood through the heart of human beings.
82. Describe the process of urine formation in kidneys.

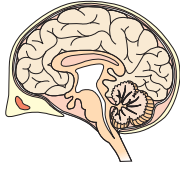

CHAPTER 7

Control and Coordination

Multiple Choice Questions

- Which of the following statements is correct about receptors?
 - Gustatory receptors detect taste while olfactory receptors detect smell
 - Both gustatory and olfactory receptors detect smell
 - Auditory receptors detect smell and olfactory receptors detect taste
 - Olfactory receptors detect taste and gustatory receptors smell
- Electrical impulse travels in a neuron from
 - Dendrite → axon → axonal end → cell body
 - Cell body → dendrite → axon → axonal end
 - Dendrite → cell body → axon → axonal end
 - Axonal end → axon → cell body → dendrite
- In a synapse, chemical signal is transmitted from
 - dendritic end of one neuron to axonal end of another neuron
 - axon to cell body of the same neuron
 - cell body to axonal end of the same neuron
 - axonal end of one neuron to dendritic end of another neuron
- In a neuron, conversion of electrical signal to a chemical signal occurs at/in
 - cell body
 - axonal end
 - dendritic end
 - axon
- Which is the correct sequence of the components of a reflex arc?
 - Receptors → Muscles → Sensory neuron → Motor neuron → Spinal cord
 - Receptors → Motor neuron → Spinal cord → Sensory neuron → Muscle
 - Receptors → Spinal cord → Sensory neuron → Motor neuron → Muscle
 - Receptors → Sensory neuron → Spinal cord → Motor neuron → Muscle

- 6.** Which of the following statements are true?
- (i) Sudden action in response to something in the environment is called reflex action
 - (ii) Sensory neurons carry signals from spinal cord to muscles
 - (iii) Motor neurons carry signals from receptors to spinal cord
 - (iv) The path through which signals are transmitted from a receptor to a muscle or a gland is called reflex arc
- (a) (i) and (ii) (b) (i) and (iii)
(c) (i) and (iv) (d) (i) , (ii) and (iii)
- 7.** Which of the following statements are true about the brain?
- (i) The main thinking part of brain is hind brain
 - (ii) Centres of hearing, smell, memory, sight etc are located in fore brain.
 - (iii) Involuntary actions like salivation, vomiting, blood pressure are controlled by the medulla in the hind brain
 - (iv) Cerebellum does not control posture and balance of the body
- (a) (i) and (ii) (b) (i), (ii) and (iii)
(c) (ii) and (iii) (d) (iii) and (iv)
- 8.** Posture and balance of the body is controlled by
- (a) cerebrum
 - (b) cerebellum
 - (c) medulla
 - (d) pons
- 9.** Spinal cord originates from
- (a) cerebrum
 - (b) medulla
 - (c) pons
 - (d) cerebellum
- 10.** The movement of shoot towards light is
- (a) geotropism
 - (b) hydrotropism
 - (c) chemotropism
 - (d) phototropism
- 11.** The main function of abscisic acid in plants is to
- (a) increase the length of cells
 - (b) promote cell division
 - (c) inhibit growth
 - (d) promote growth of stem

- 12.** Which of the following is not associated with growth of plant?
- (a) Auxin
 - (b) Gibberellins
 - (c) Cytokinins
 - (d) Abscisic acid
- 13.** Iodine is necessary for the synthesis of which hormone?
- (a) Adrenaline
 - (b) Thyroxin
 - (c) Auxin
 - (d) Insulin
- 14.** Choose the incorrect statement about insulin
- (a) It is produced from pancreas
 - (b) It regulates growth and development of the body
 - (c) It regulates blood sugar level
 - (d) Insufficient secretion of insulin will cause diabetes
- 15.** Select the mis-matched pair
- (a) Adrenaline : Pituitary gland
 - (b) Testosterone: Testes
 - (c) Estrogen : Ovary
 - (d) Thyroxin : Thyroid gland
- 16.** The shape of guard cells changes due to change in the
- (a) protein composition of cells
 - (b) temperature of cells
 - (c) amount of water in cells
 - (d) position of nucleus in the cells
- 17.** The growth of tendrils in pea plants is due to
- (a) effect of light
 - (b) effect of gravity
 - (c) rapid cell divisions in tendrillar cells that are away from the support
 - (d) rapid cell divisions in tendrillar cells in contact with the support
- 18.** The growth of pollen tubes towards ovules is due to
- (a) hydrotropism
 - (b) chemotropism
 - (c) geotropism
 - (d) phototropism

- 19.** The movement of sunflower in accordance with the path of sun is due to
- (a) phototropism
 - (b) geotropism
 - (c) chemotropism
 - (d) hydrotropism
- 20.** The substance that triggers the fall of mature leaves and fruits from plants is due to
- (a) auxin
 - (b) gibberellin
 - (c) abscisic acid
 - (d) cytokinin
- 21.** Which of the following statements about transmission of nerve impulse is incorrect?
- (a) Nerve impulse travels from dendritic end towards axonal end
 - (b) At the dendritic end electrical impulses bring about the release of some chemicals which generate an electrical impulse at the axonal end of another neuron
 - (c) The chemicals released from the axonal end of one neuron cross the synapse and generate a similar electrical impulse in a dendrite of another neuron
 - (d) A neuron transmits electrical impulses not only to another neuron but also to muscle and gland cells
- 22.** Involuntary actions in the body are controlled by
- (a) medulla in fore brain
 - (b) medulla in mid brain
 - (c) medulla in hind brain
 - (d) medulla in spinal cord
- 23.** Which of the following is not an involuntary action?
- (a) Vomiting
 - (b) Salivation
 - (c) Heart beat
 - (d) Chewing
- 24.** When a person is suffering from severe cold, he or she cannot
- (a) differentiate the taste of an apple from that of an ice cream
 - (b) differentiate the smell of a perfume from that of an **agarbatti**
 - (c) differentiate red light from green light
 - (d) differentiate a hot object from a cold object

25. What is the correct direction of flow of electrical impulses?

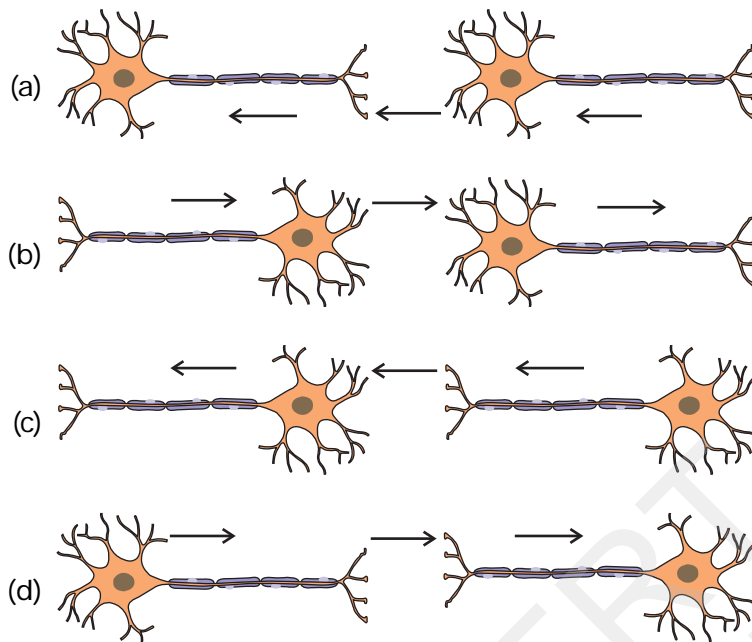

Fig. 7.1

26. Which statement is not true about thyroxin?

- (a) Iron is essential for the synthesis of thyroxin
- (b) It regulates carbohydrates, protein and fat metabolism in the body
- (c) Thyroid gland requires iodine to synthesise thyroxin
- (d) Thyroxin is also called thyroid hormone

27. Dwarfism results due to

- (a) Excess secretion of thyroxin
- (b) Less secretion of growth hormone
- (c) Less secretion of adrenaline
- (d) Excess secretion of growth hormone

28. Dramatic changes of body features associated with puberty are mainly because of secretion of

- (a) oestrogen from testes and testosterone from ovary
- (b) estrogen from adrenal gland and testosterone from pituitary gland
- (c) testosterone from testes and estrogen from ovary
- (d) testosterone from thyroid gland and estrogen from pituitary gland

29. A doctor advised a person to take an injection of insulin because

- (a) his blood pressure was low
- (b) his heart was beating slowly
- (c) he was suffering from goitre
- (d) his sugar level in blood was high

- 30.** The hormone which increases the fertility in males is called
- (a) oestrogen
 - (b) testosterone
 - (c) insulin
 - (d) growth hormone
- 31.** Which of the following endocrine glands is unpaired?
- (a) Adrenal
 - (b) Testes
 - (c) Pituitary
 - (d) Ovary
- 32.** Junction between two neurons is called
- (a) cell junction
 - (b) neuro muscular junction
 - (c) neural joint
 - (d) synapse
- 33.** In humans, the life processes are controlled and regulated by
- (a) reproductive and endocrine systems
 - (b) respiratory and nervous systems
 - (c) endocrine and digestive systems
 - (d) nervous and endocrine systems

Short Answer Questions

- 34.** Label the parts (a), (b), (c) and (d) and show the direction of flow of electrical signals in Figure 7.2.

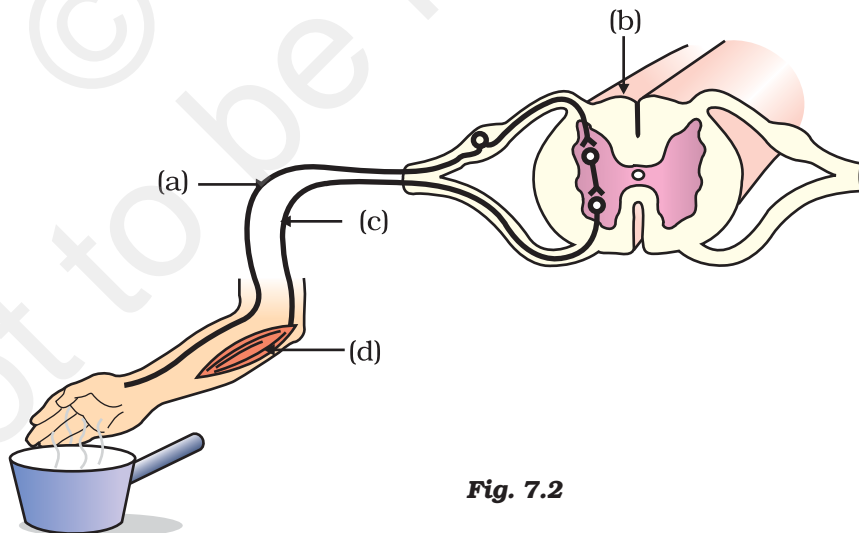

Fig. 7.2

35. Name the plant hormones responsible for the following

- (a) elongation of cells
- (b) growth of stem
- (c) promotion of cell division
- (d) falling of senescent leaves.

36. Label the endocrine glands in Figure 7.3.

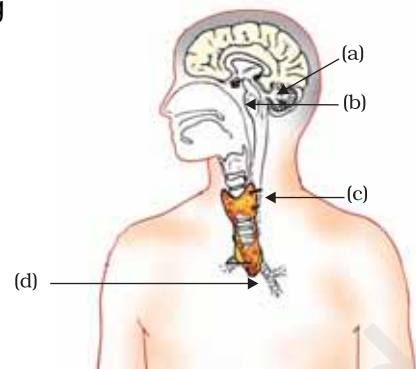

Fig. 7.3

37. In Figure 7.4 (a), (b) and (c), which appears more accurate and why?

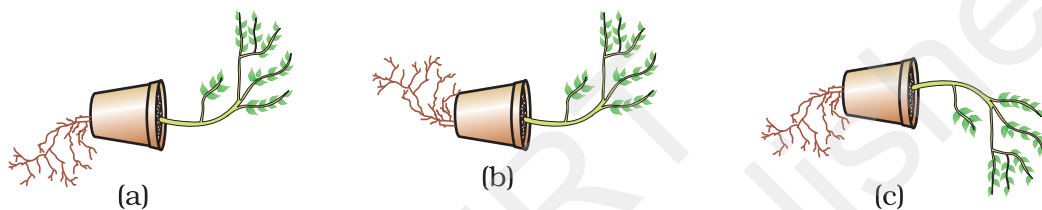

Fig. 7.4

38. Label the parts of a neuron in Figure 7.5.

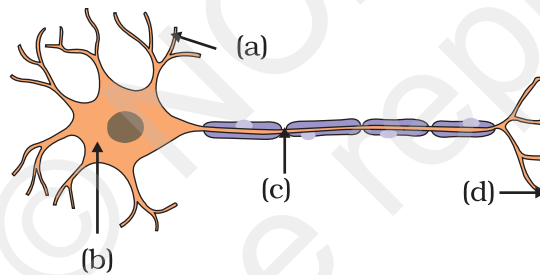

Fig. 7.5

39. Match the terms of Column (A) with those of Column (B)

Column (A)	Column (B)
(a) Olfactory receptors	(i) Tongue
(b) Thermo receptors (temperature receptors)	(ii) Eye
(c) Gustatoreceptors	(iii) Nose
(d) Photoreceptors	(iv) Skin

40. What is a tropic movement? Explain with an example.

41. What will happen if intake of iodine in our diet is low?

42. What happens at the synapse between two neurons?

- 43.** Answer the following :
- (a) Which hormone is responsible for the changes noticed in females at puberty?
 - (b) Dwarfism results due to deficiency of which hormone?
 - (c) Blood sugar level rises due to deficiency of which hormone?
 - (d) Iodine is necessary for the synthesis of which hormone?
- 44.** Answer the following :
- (a) Name the endocrine gland associated with brain?
 - (b) Which gland secretes digestive enzymes as well as hormones?
 - (c) Name the endocrine gland associated with kidneys?
 - (d) Which endocrine gland is present in males but not in females?

Long Answer Questions

- 45.** Draw the structure of a neuron and explain its function.
- 46.** What are the major parts of the brain? Mention the functions of different parts.
- 47.** What constitutes the central and peripheral nervous systems? How are the components of central nervous system protected?
- 48.** Mention one function for each of these hormones :
- (a) Thyroxin
 - (b) Insulin
 - (c) Adrenaline
 - (d) Growth hormone
 - (e) Testosterone.
- 49.** Name various plant hormones. Also give their physiological effects on plant growth and development.
- 50.** What are reflex actions? Give two examples. Explain a reflex arc.
- 51.** "Nervous and hormonal systems together perform the function of control and coordination in human beings." Justify the statement.
- 52.** How does chemical coordination take place in animals?
- 53.** Why is the flow of signals in a synapse from axonal end of one neuron to dendritic end of another neuron but not the reverse?



CHAPTER 8

How do Organisms Reproduce?

Multiple Choice Questions

- In the list of organisms given below, those that reproduce by the asexual method are

 - banana
 - dog
 - yeast
 - Amoeba

(a) (ii) and (iv) (b) (i), (iii) and (iv)
(c) (i) and (iv) (d) (ii), (iii) and (iv)
- In a flower, the parts that produce male and female gametes (germ cells) are

 - stamen and anther
 - filament and stigma
 - anther and ovary
 - stamen and style
- Which of the following is the correct sequence of events of sexual reproduction in a flower?

 - pollination, fertilisation, seedling, embryo
 - seedling, embryo, fertilisation, pollination
 - pollination, fertilisation, embryo, seedling
 - embryo, seedling, pollination, fertilisation
- Offspring formed by asexual method of reproduction have greater similarity among themselves because

 - asexual reproduction involves only one parent
 - asexual reproduction does not involve gametes
 - asexual reproduction occurs before sexual reproduction
 - asexual reproduction occurs after sexual reproduction

(a) (i) and (ii) (b) (i) and (iii)
(c) (ii) and (iv) (d) (iii) and (iv)

5. Characters transmitted from parents to offspring are present in
- (a) cytoplasm
 - (b) ribosome
 - (c) golgi bodies
 - (d) genes
6. Characters that are transmitted from parents to offspring during reproduction show
- (a) only similarities with parents
 - (b) only variations with parents
 - (c) both similarities and variations with parents
 - (d) neither similarities nor variations
7. A feature of reproduction that is common to *Amoeba*, *Spirogyra* and Yeast is that
- (a) they reproduce asexually
 - (b) they are all unicellular
 - (c) they reproduce only sexually
 - (d) they are all multicellular
8. In *Spirogyra*, asexual reproduction takes place by
- (a) breaking up of filaments into smaller bits
 - (b) division of a cell into two cells
 - (c) division of a cell into many cells
 - (d) formation of young cells from older cells.
9. The ability of a cell to divide into several cells during reproduction in *Plasmodium* is called
- (a) budding
 - (b) reduction division
 - (c) binary fission
 - (d) multiple fission
10. The correct sequence of reproductive stages seen in flowering plants is
- (a) gametes, zygote, embryo, seedling
 - (b) zygote, gametes, embryo, seedling
 - (c) seedling, embryo, zygote, gametes
 - (d) gametes, embryo, zygote, seedling
11. The number of chromosomes in parents and offsprings of a particular species remains constant due to
- (a) doubling of chromosomes after zygote formation
 - (b) halving of chromosomes during gamete formation
 - (c) doubling of chromosomes after gamete formation
 - (d) halving of chromosomes after gamete formation

- 12.** In *Rhizopus*, tubular thread-like structures bearing sporangia at their tips are called
- (a) filaments
 - (b) hyphae
 - (c) rhizoids
 - (d) roots
- 13.** Vegetative propagation refers to formation of new plants from
- (a) stem, roots and flowers
 - (b) stem, roots and leaves
 - (c) stem, flowers and fruits
 - (d) stem, leaves and flowers
- 14.** Factors responsible for the rapid spread of bread mould on slices of bread are
- (i) large number of spores
 - (ii) availability of moisture and nutrients in bread
 - (iii) presence of tubular branched hyphae
 - (iv) formation of round shaped sporangia
- (a) (i) and (iii)
 - (b) (ii) and (iv)
 - (c) (i) and (ii)
 - (d) (iii) and (iv)
- 15.** Length of pollen tube depends on the distance between
- (a) pollen grain and upper surface of stigma
 - (b) pollen grain on upper surface of stigma and ovule
 - (c) pollen grain in anther and upper surface of stigma
 - (d) upper surface of stigma and lower part of style
- 16.** Which of the following statements are true for flowers?
- (i) Flowers are always bisexual
 - (ii) They are the sexual reproductive organs
 - (iii) They are produced in all groups of plants
 - (iv) After fertilisation they give rise to fruits
- (a) (i) and (iv)
 - (b) (ii) and (iii)
 - (c) (i) and (iii)
 - (d) (ii) and (iv)
- 17.** Which among the following statements are true for unisexual flowers?
- (i) They possess both stamen and pistil
 - (ii) They possess either stamen or pistil
 - (iii) They exhibit cross pollination
 - (iv) Unisexual flowers possessing only stamens cannot produce fruits
- (a) (i) and (iv)
 - (b) (ii), (iii) and (iv)
 - (c) (iii) and (iv)
 - (d) (i), (iii) and (iv)

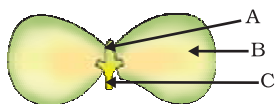

Fig. 8.1

- 18.** Which among the following statements are true for sexual reproduction in flowering plants?
- It requires two types of gametes
 - Fertilisation is a compulsory event
 - It always results in formation of zygote
 - Offspring formed are clones
- (a) (i) and (iv) (b) (i), (ii) and (iv)
 (c) (i), (ii) and (iii) (d) (i), (ii) and (iv)
- 19.** In Figure 8.1, the parts A, B and C are sequentially
- cotyledon, plumule and radicle
 - plumule, radicle and cotyledon
 - plumule, cotyledon and radicle
 - radicle, cotyledon and plumule
- 20.** Offspring formed as a result of sexual reproduction exhibit more variations because
- sexual reproduction is a lengthy process
 - genetic material comes from two parents of the same species
 - genetic material comes from two parents of different species
 - genetic material comes from many parents
- 21.** Reproduction is essential for living organisms in order to
- keep the individual organism alive
 - fulfill their energy requirement
 - maintain growth
 - continue the species generation after generation
- 22.** During adolescence, several changes occur in the human body. Mark one change associated with sexual maturation in boys
- loss of milk teeth
 - increase in height
 - cracking of voice
 - weight gain
- 23.** In human females, an event that reflects onset of reproductive phase is
- growth of body
 - changes in hair pattern
 - change in voice
 - menstruation

- 24.** In human males, the testes lie in the scrotum, because it helps in the
- (a) process of mating
 - (b) formation of sperm
 - (c) easy transfer of gametes
 - (d) all the above
- 25.** Which among the following is not the function of testes at puberty?
- (i) formation of germ cells
 - (ii) secretion of testosterone
 - (iii) development of placenta
 - (iv) secretion of estrogen
- (a) (i) and (ii) (b) (ii) and (iii)
(c) (iii) and (iv) (d) (i) and (iv)
- 26.** The correct sequence of organs in the male reproductive system for transport of sperms is
- (a) testis → vasdeferens → urethra
 - (b) testis → ureter → urethra
 - (c) testis → urethra → ureter
 - (d) testis → vasdeferens → ureter
- 27.** Which among the following diseases is not sexually transmitted?
- (a) Syphilis
 - (b) Hepatitis
 - (c) HIV - AIDS
 - (d) Gonorrhoea

Short Answer Questions

- 28.** In a bisexual flower inspite of the young stamens being removed artificially, the flower produces fruit. Provide a suitable explanation for the above situation.
- 29.** Can you consider cell division as a type of reproduction in unicellular organism? Give one reason.
- 30.** What is a clone? Why do offsprings formed by asexual reproduction exhibit remarkable similarity?
- 31.** Explain how, offspring and parents of organisms reproducing sexually have the same number of chromosomes?
- 32.** Colonies of yeast fail to multiply in water, but multiply in sugar solution. Give one reason for this.

- 33.** Why does bread mould grow profusely on a moist slice of bread rather than on a dry slice of bread?
- 34.** Give two reasons for the appearance of variations among the progeny formed by sexual reproduction.
- 35.** Would a *Planaria* cut vertically into two halves regenerate into two individuals? Complete Figure 8.2 D and E by indicating the regenerated regions.

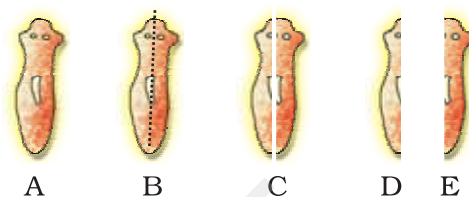

Fig. 8.2

- 36.** From the internet, gather information about the chromosome numbers of five animals and five plants. Correlate the number with the size of organism and answer the following questions.
- Do larger organisms have more number of chromosomes/cells?
 - Can organism with fewer chromosomes reproduce more easily than organisms with more number of chromosomes?
 - More the number of chromosomes/cells greater is the DNA content. Justify.
- 37.** In tobacco plant, the male gametes have twenty four chromosomes. What is the number of chromosomes in the female gamete? What is the number of chromosomes in the zygote?
- 38.** Why cannot fertilisation take place in flowers if pollination does not occur?
- 39.** Is the chromosome number of zygote, embryonal cells and adult of a particular organism always constant? How is the constancy maintained in these three stages?
- 40.** Where is the zygote located in the flower after fertilization?
- 41.** Reproduction is linked to stability of population of a species. Justify the statement.
- 42.** How are general growth and sexual maturation different from each other?
- 43.** Trace the path of sperm during ejaculation and mention the gland and their functions associated with the male reproductive system.

44. What changes are observed in the uterus if fertilisation does not occur?
45. What changes are observed in the uterus subsequent to implantation of young embryo?
46. What are the benefits of using mechanical barriers during sexual act?
47. In the given Figure 8.3 label the parts and mention their functions
- Production of egg
 - Site of fertilisation
 - Site of implantation
 - Entry of the sperms



Fig. 8.3

48. What would be the ratio of chromosome number between an egg and its zygote? How is the sperm genetically different from the egg?

Long Answer Questions

49. Why are budding, fragmentation and regeneration all considered as asexual types of reproduction? With neat diagrams explain the process of regeneration in **Planaria**.
50. Write two points of difference between asexual and sexual types of reproduction. Describe why variations are observed in the offspring formed by sexual reproduction.
51. Distinguish between pollination and fertilisation. Mention the site and product of fertilisation in a flower. Draw a neat, labelled diagram of a pistil showing pollen tube growth and its entry into the ovule.
52. Distinguish between a gamete and zygote. Explain their roles in sexual reproduction.
53. Draw the diagram of a flower and label the four whorls. Write the names of gamete producing organs in the flower.

- 54.** What is placenta? Mention its role during pregnancy?
- 55.** What are various ways to avoid pregnancy? Elaborate any one method.
- 56.** How does fertilisation take place? Fertilisation occurs once in a month. Comment.
- 57.** Reproduction is essentially a phenomenon that is not for survival of an individual but for the stability of a species. Justify.
- 58.** Describe sexually transmitted diseases and mention the ways to prevent them.



CHAPTER 9



Heredity and Evolution

Multiple Choice Questions

- Exchange of genetic material takes place in
 - vegetative reproduction
 - asexual reproduction
 - sexual reproduction
 - budding
- Two pink coloured flowers on crossing resulted in 1 red, 2 pink and 1 white flower progeny. The nature of the cross will be
 - double fertilisation
 - self pollination
 - cross fertilisation
 - no fertilisation
- A cross between a tall plant (TT) and short pea plant (tt) resulted in progeny that were all tall plants because
 - tallness is the dominant trait
 - shortness is the dominant trait
 - tallness is the recessive trait
 - height of pea plant is not governed by gene 'T' or 't'
- Which of the following statement is incorrect?
 - For every hormone there is a gene.
 - For every protein there is a gene.
 - For production of every enzyme there is a gene.
 - For every molecule of fat there is a gene
- If a round, green seeded pea plant (RR yy) is crossed with wrinkled, yellow seeded pea plant, (rr YY) the seeds produced in F₁ generation are
 - round and yellow
 - round and green
 - wrinkled and green
 - wrinkled and yellow

6. In human males all the chromosomes are paired perfectly except one. This/these unpaired chromosome is/are
- (i) large chromosome
 - (ii) small chromosome
 - (iii) Y-chromosome
 - (iv) X-chromosome
- (a) (i) and (ii) (b) (iii) only
(c) (iii) and (iv) (d) (ii) and (iv)
7. The maleness of a child is determined by
- (a) the X chromosome in the zygote
 - (b) the Y chromosome in zygote
 - (c) the cytoplasm of germ cell which determines the sex
 - (d) sex is determined by chance
8. A zygote which has an X-chromosome inherited from the father will develop into a
- (a) boy
 - (b) girl
 - (c) X- chromosome does not determine the sex of a child
 - (d) either boy or girl
9. Select the incorrect statement
- (a) Frequency of certain genes in a population change over several generations resulting in evolution
 - (b) Reduction in weight of the organism due to starvation is genetically controlled
 - (c) Low weight parents can have heavy weight progeny
 - (d) Traits which are not inherited over generations do not cause evolution
10. New species may be formed if
- (i) DNA undergoes significant changes in germ cells
 - (ii) chromosome number changes in the gamete
 - (iii) there is no change in the genetic material
 - (iv) mating does not take place
- (a) (i) and (ii) (b) (i) and (iii)
(c) (ii), (iii) and (iv) (d) (i), (ii) and (iii)
11. Two pea plants one with round green seeds (RRyy) and another with wrinkled yellow (rrYY) seeds produce F_1 progeny that have round, yellow (RrYy) seeds. When F_1 plants are selfed, the F_2 progeny will have new combination of characters. Choose the new combination from the following

- (i) Round, yellow
 - (ii) Round, green
 - (iii) Wrinkled, yellow
 - (iv) Wrinkled, green
 - (a) (i) and (ii) (b) (i) and (iv)
 - (c) (ii) and (iii) (d) (i) and (iii)
- 12.** A basket of vegetables contains carrot, potato, radish and tomato. Which of them represent the correct homologous structures?
- (a) Carrot and potato
 - (b) Carrot and tomato
 - (c) Radish and carrot
 - (d) Radish and potato
- 13.** Select the correct statement
- (a) Tendril of a pea plant and phylloclade of *Opuntia* are homologous
 - (b) Tendril of a pea plant and phylloclade of *Opuntia* are analogous
 - (c) Wings of birds and limbs of lizards are analogous
 - (d) Wings of birds and wings of bat are homologous
- 14.** If the fossil of an organism is found in the deeper layers of earth, then we can predict that
- (a) the extinction of organism has occurred recently
 - (b) the extinction of organism has occurred thousands of years ago
 - (c) the fossil position in the layers of earth is not related to its time of extinction
 - (d) time of extinction cannot be determined
- 15.** Which of the following statements is not true with respect to variation?
- (a) All variations in a species have equal chance of survival
 - (b) Change in genetic composition results in variation
 - (c) Selection of variants by environmental factors forms the basis of evolutionary processes.
 - (d) Variation is minimum in asexual reproduction
- 16.** A trait in an organism is influenced by
- (a) paternal DNA only
 - (b) maternal DNA only
 - (c) both maternal and paternal DNA
 - (d) neither by paternal nor by maternal DNA

- 17.** Select the group which shares maximum number of common characters
- (a) two individuals of a species
 - (b) two species of a genus
 - (c) two genera of a family
 - (d) two genera of two families
- 18.** According to the evolutionary theory, formation of a new species is generally due to
- (a) sudden creation by nature
 - (b) accumulation of variations over several generations
 - (c) clones formed during asexual reproduction
 - (d) movement of individuals from one habitat to another
- 19.** From the list given below, select the character which can be acquired but not inherited
- (a) colour of eye
 - (b) colour of skin
 - (c) size of body
 - (d) nature of hair
- 20.** The two versions of a trait (character) which are brought in by the male and female gametes are situated on
- (a) copies of the same chromosome
 - (b) two different chromosomes
 - (c) sex chromosomes
 - (d) any chromosome
- 21.** Select the statements that describe characteristics of genes
- (i) genes are specific sequence of bases in a DNA molecule
 - (ii) a gene does not code for proteins
 - (iii) in individuals of a given species, a specific gene is located on a particular chromosome
 - (iv) each chromosome has only one gene
- (a) (i) and (ii) (b) (i) and (iii)
(c) (i) and (iv) (d) (ii) and (iv)
- 22.** In peas, a pure tall plant (TT) is crossed with a short plant (tt). The ratio of pure tall plants to short plants in F_2 is
- (a) 1 : 3
 - (b) 3 : 1
 - (c) 1 : 1
 - (d) 2 : 1

- 23.** The number of pair (s) of sex chromosomes in the zygote of humans is
- (a) one (b) two
(c) three (d) four
- 24.** The theory of evolution of species by natural selection was given by
- (a) Mendel (b) Darwin
(c) Morgan (d) Lamarck
- 25.** Some dinosaurs had feathers although they could not fly but birds have feathers that help them to fly. In the context of evolution this means that
- (a) reptiles have evolved from birds
(b) there is no evolutionary connection between reptiles and birds
(c) feathers are homologous structures in both the organisms
(d) birds have evolved from reptiles

Short Answer Questions

- 26.** How is the sex of a newborn determined in humans?
- 27.** Do genetic combination of mothers play a significant role in determining the sex of a new born?
- 28.** Mention three important features of fossils which help in the study of evolution.
- 29.** Why do all the gametes formed in human females have an X chromosome?
- 30.** In human beings, the statistical probability of getting either a male or female child is 50 : 50. Give a suitable explanation.
- 31.** A very small population of a species faces a greater threat of extinction than a larger population. Provide a suitable genetic explanation.
- 32.** What are homologous structures? Give an example. Is it necessary that homologous structures always have a common ancestor?
- 33.** Does the occurrence of diversity of animals on earth suggest their diverse ancestry also? Discuss this point in the light of evolution.
- 34.** Give the pair of contrasting traits of the following characters in pea plant and mention which is dominant and recessive
- (i) yellow seed (ii) round seed
- 35.** Why did Mendel choose pea plant for his experiments?

36. A woman has only daughters. Analyse the situation genetically and provide a suitable explanation.

Long Answer Questions

37. Does geographical isolation of individuals of a species lead to formation of a new species? Provide a suitable explanation.
38. Bacteria have a simpler body plan when compared with human beings. Does it mean that human beings are more evolved than bacteria? Provide a suitable explanation.
39. All the human races like Africans, Asians, Europeans, Americans and others might have evolved from a common ancestor. Provide a few evidences in support of this view.
40. Differentiate between inherited and acquired characters. Give one example for each type.
41. Give reasons why acquired characters are not inherited.
42. Evolution has exhibited a greater stability of molecular structure when compared with morphological structures. Comment on the statement and justify your opinion.
43. In the following crosses write the characteristics of the progeny

Cross	Progeny
(a) RR YY x RR YY Round, yellow Round, yellow
(b) Rr Yy x Rr Yy Round, yellow Round, yellow
(c) rr yy x rr yy wrinkled, green wrinkled, green
(d) RR YY x rr yy Round, yellow wrinkled green

44. Study the following cross and showing self pollination in F_1 , fill in the blank and answer the question that follows

Parents	RRYY	x	rryy
	Round, yellow		wrinkled, green
F_1 —	Rr Yy	x	?
	Round, yellow		

45. In question 44, what are the combinations of character in the F_2 progeny? What are their ratios?
46. Give the basic features of the mechanism of inheritance.
47. Give reasons for the appearance of new combinations of characters in the F_2 progeny.

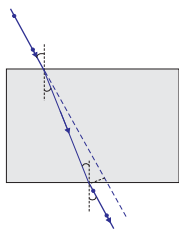

CHAPTER 10

Light – Reflection and Refraction

Multiple Choice Questions

- Which of the following can make a parallel beam of light when light from a point source is incident on it?
 - Concave mirror as well as convex lens
 - Convex mirror as well as concave lens
 - Two plane mirrors placed at 90° to each other
 - Concave mirror as well as concave lens
- A 10 mm long awl pin is placed vertically in front of a concave mirror. A 5 mm long image of the awl pin is formed at 30 cm in front of the mirror. The focal length of this mirror is
 - 30 cm
 - 20 cm
 - 40 cm
 - 60 cm
- Under which of the following conditions a concave mirror can form an image larger than the actual object?
 - When the object is kept at a distance equal to its radius of curvature
 - When object is kept at a distance less than its focal length
 - When object is placed between the focus and centre of curvature
 - When object is kept at a distance greater than its radius of curvature
- Figure 10.1 shows a ray of light as it travels from medium A to medium B. Refractive index of the medium B relative to medium A is
 - $\sqrt{3}/\sqrt{2}$
 - $\sqrt{2}/\sqrt{3}$
 - $1/\sqrt{2}$
 - $\sqrt{2}$

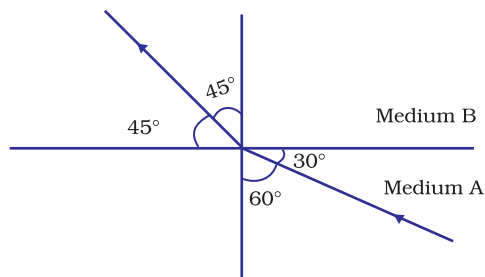

Fig. 10.1

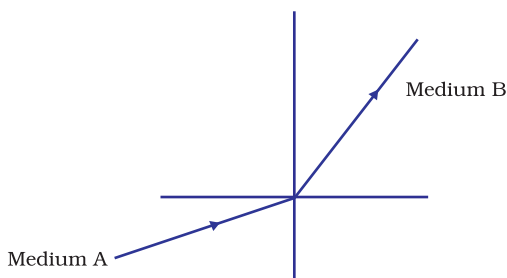

Fig. 10.2

5. A light ray enters from medium A to medium B as shown in Figure 10.2. The refractive index of medium B relative to A will be
- greater than unity
 - less than unity
 - equal to unity
 - zero

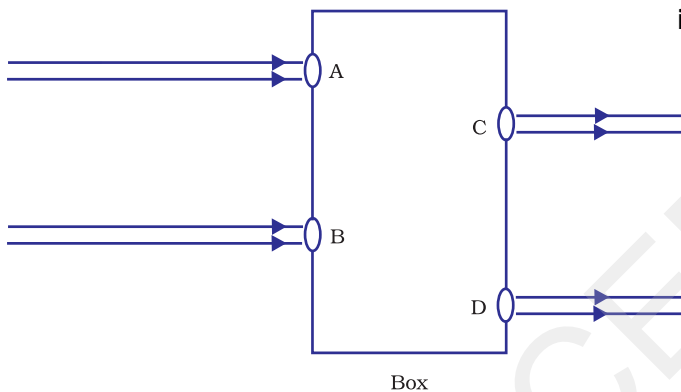

Fig. 10.3

- A rectangular glass slab
- A convex lens
- A concave lens
- A prism

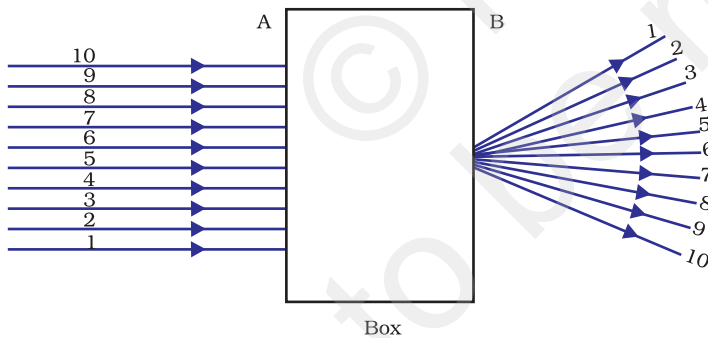

Fig. 10.4

7. A beam of light is incident through the holes on side A and emerges out of the holes on the other face of the box as shown in the Figure 10.4. Which of the following could be inside the box?

- Concave lens
- Rectangular glass slab
- Prism
- Convex lens

8. Which of the following statements is true?

- A convex lens has 4 dioptre power having a focal length 0.25 m
- A convex lens has -4 dioptre power having a focal length 0.25 m
- A concave lens has 4 dioptre power having a focal length 0.25 m
- A concave lens has -4 dioptre power having a focal length 0.25 m

9. Magnification produced by a rear view mirror fitted in vehicles
- is less than one
 - is more than one
 - is equal to one
 - can be more than or less than one depending upon the position of the object in front of it
10. Rays from Sun converge at a point 15 cm in front of a concave mirror. Where should an object be placed so that size of its image is equal to the size of the object?
- 15 cm in front of the mirror
 - 30 cm in front of the mirror
 - between 15 cm and 30 cm in front of the mirror
 - more than 30 cm in front of the mirror
11. A full length image of a distant tall building can definitely be seen by using
- a concave mirror
 - a convex mirror
 - a plane mirror
 - both concave as well as plane mirror
12. In torches, search lights and headlights of vehicles the bulb is placed
- between the pole and the focus of the reflector
 - very near to the focus of the reflector
 - between the focus and centre of curvature of the reflector
 - at the centre of curvature of the reflector

13. The laws of reflection hold good for
- plane mirror only
 - concave mirror only
 - convex mirror only
 - all mirrors irrespective of their shape

14. The path of a ray of light coming from air passing through a rectangular glass slab traced by four students are shown as A, B, C and D in Figure 10.5. Which one of them is correct?

- A
- B
- C
- D

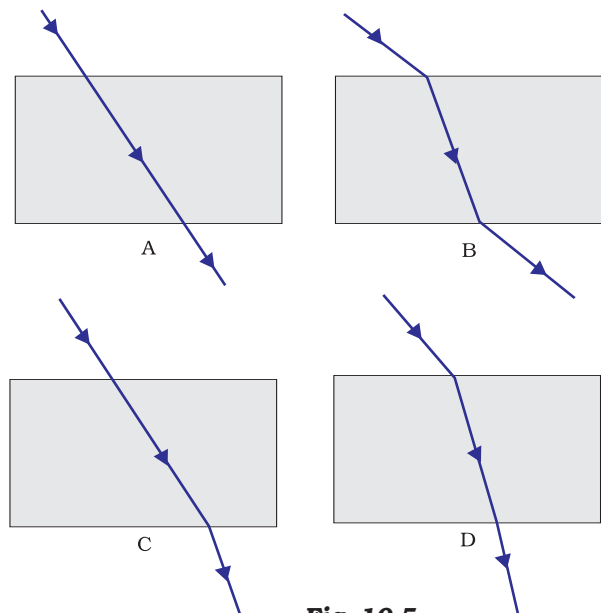

Fig. 10.5

15. You are given water, mustard oil, glycerine and kerosene. In which of these media a ray of light incident obliquely at same angle would bend the most?

- (a) Kerosene
- (b) Water
- (c) Mustard oil
- (d) Glycerine

16. Which of the following ray diagrams is correct for the ray of light incident on a concave mirror as shown in Figure 10.6?

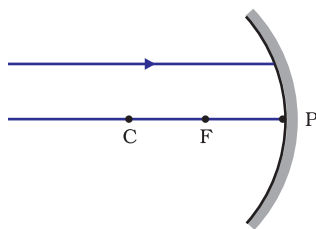

Fig. 10.6

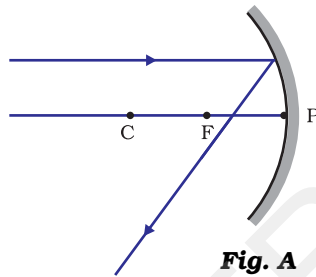

Fig. A

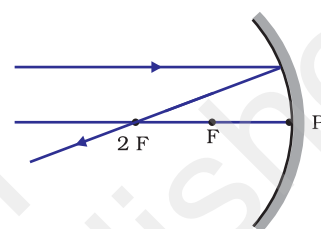

Fig. B

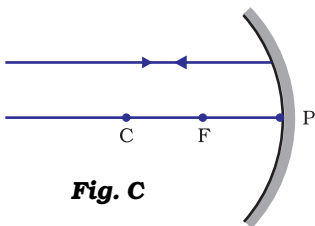

Fig. C

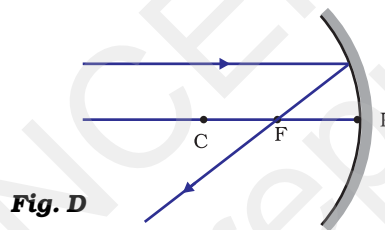

Fig. D

- (a) Fig. A
- (b) Fig. B
- (c) Fig. C
- (d) Fig. D

17. Which of the following ray diagrams is correct for the ray of light incident on a lens shown in Fig. 10.7?

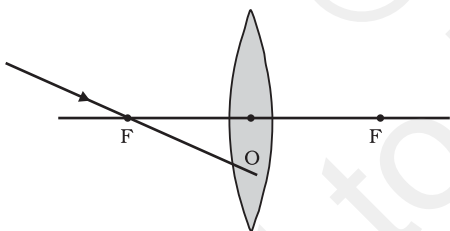

Fig. 10.7

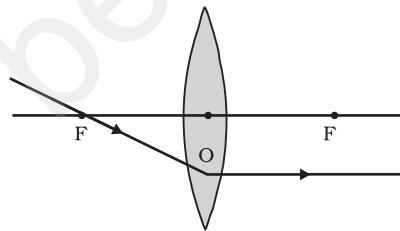

Fig. A

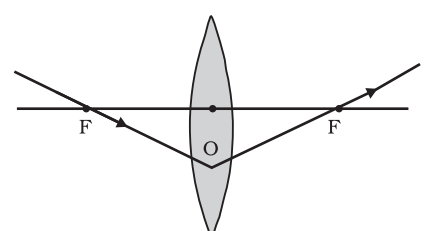

Fig. B

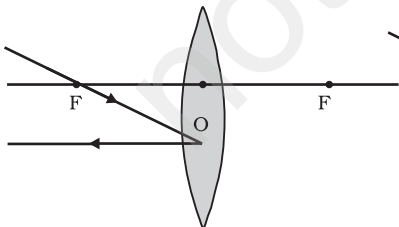

Fig. C

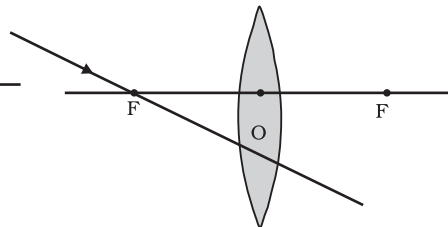

Fig. D

- (a) Fig. A.
- (b) Fig. B.
- (c) Fig. C.
- (d) Fig. D.

- 18.** A child is standing in front of a magic mirror. She finds the image of her head bigger, the middle portion of her body of the same size and that of the legs smaller. The following is the order of combinations for the magic mirror from the top.
- (a) Plane, convex and concave
 - (b) Convex, concave and plane
 - (c) Concave, plane and convex
 - (d) Convex, plane and concave
- 19.** In which of the following, the image of an object placed at infinity will be highly diminished and point sized?
- (a) Concave mirror only
 - (b) Convex mirror only
 - (c) Convex lens only
 - (d) Concave mirror, convex mirror, concave lens and convex lens

Short Answer Questions

- 20.** Identify the device used as a spherical mirror or lens in following cases, when the image formed is virtual and erect in each case.
- (a) Object is placed between device and its focus, image formed is enlarged and behind it.
 - (b) Object is placed between the focus and device, image formed is enlarged and on the same side as that of the object.
 - (c) Object is placed between infinity and device, image formed is diminished and between focus and optical centre on the same side as that of the object.
 - (d) Object is placed between infinity and device, image formed is diminished and between pole and focus, behind it.
- 21.** Why does a light ray incident on a rectangular glass slab immersed in any medium emerges parallel to itself? Explain using a diagram.
- 22.** A pencil when dipped in water in a glass tumbler appears to be bent at the interface of air and water. Will the pencil appear to be bent to the same extent, if instead of water we use liquids like, kerosene or turpentine. Support your answer with reason.
- 23.** How is the refractive index of a medium related to the speed of light? Obtain an expression for refractive index of a medium with respect to another in terms of speed of light in these two media?
- 24.** Refractive index of diamond with respect to glass is 1.6 and absolute refractive index of glass is 1.5. Find out the absolute refractive index of diamond.

- 25.** A convex lens of focal length 20 cm can produce a magnified virtual as well as real image. Is this a correct statement? If yes, where shall the object be placed in each case for obtaining these images?
- 26.** Sudha finds out that the sharp image of the window pane of her science laboratory is formed at a distance of 15 cm from the lens. She now tries to focus the building visible to her outside the window instead of the window pane without disturbing the lens. In which direction will she move the screen to obtain a sharp image of the building? What is the approximate focal length of this lens?
- 27.** How are power and focal length of a lens related? You are provided with two lenses of focal length 20 cm and 40 cm respectively. Which lens will you use to obtain more convergent light?
- 28.** Under what condition in an arrangement of two plane mirrors, incident ray and reflected ray will always be parallel to each other, whatever may be angle of incidence. Show the same with the help of diagram.
- 29.** Draw a ray diagram showing the path of rays of light when it enters with oblique incidence (i) from air into water; (ii) from water into air.

Long Answer Questions

- 30.** Draw ray diagrams showing the image formation by a concave mirror when an object is placed
- between pole and focus of the mirror
 - between focus and centre of curvature of the mirror
 - at centre of curvature of the mirror
 - a little beyond centre of curvature of the mirror
 - at infinity
- 31.** Draw ray diagrams showing the image formation by a convex lens when an object is placed
- between optical centre and focus of the lens
 - between focus and twice the focal length of the lens
 - at twice the focal length of the lens
 - at infinity
 - at the focus of the lens
- 32.** Write laws of refraction. Explain the same with the help of ray diagram, when a ray of light passes through a rectangular glass slab.

- 33.** Draw ray diagrams showing the image formation by a concave lens when an object is placed
- (a) at the focus of the lens
 - (b) between focus and twice the focal length of the lens
 - (c) beyond twice the focal length of the lens
- 34.** Draw ray diagrams showing the image formation by a convex mirror when an object is placed
- (a) at infinity
 - (b) at finite distance from the mirror
- 35.** The image of a candle flame formed by a lens is obtained on a screen placed on the other side of the lens. If the image is three times the size of the flame and the distance between lens and image is 80 cm, at what distance should the candle be placed from the lens? What is the nature of the image at a distance of 80 cm and the lens?
- 36.** Size of image of an object by a mirror having a focal length of 20 cm is observed to be reduced to $\frac{1}{3}$ rd of its size. At what distance the object has been placed from the mirror? What is the nature of the image and the mirror?
- 37.** Define power of a lens. What is its unit? One student uses a lens of focal length 50 cm and another of -50 cm. What is the nature of the lens and its power used by each of them?
- 38.** A student focussed the image of a candle flame on a white screen using a convex lens. He noted down the position of the candle screen and the lens as under
- Position of candle = 12.0 cm
Position of convex lens = 50.0 cm
Position of the screen = 88.0 cm
- (i) What is the focal length of the convex lens?
 - (ii) Where will the image be formed if he shifts the candle towards the lens at a position of 31.0 cm?
 - (iii) What will be the nature of the image formed if he further shifts the candle towards the lens?
 - (iv) Draw a ray diagram to show the formation of the image in case (iii) as said above.



CHAPTER 11

The Human Eye and the Colourful World

Multiple Choice Questions

1. A person cannot see distinctly objects kept beyond 2 m. This defect can be corrected by using a lens of power
 - (a) + 0.5 D
 - (b) - 0.5 D
 - (c) + 0.2 D
 - (d) - 0.2 D
2. A student sitting on the last bench can read the letters written on the blackboard but is not able to read the letters written in his text book. Which of the following statements is correct?
 - (a) The near point of his eyes has receded away
 - (b) The near point of his eyes has come closer to him
 - (c) The far point of his eyes has come closer to him
 - (d) The far point of his eyes has receded away
3. A prism ABC (with BC as base) is placed in different orientations. A narrow beam of white light is incident on the prism as shown in Figure 11.1. In which of the following cases, after dispersion, the third colour from the top corresponds to the colour of the sky?
 - (a) (i)
 - (b) (ii)
 - (c) (iii)
 - (d) (iv)

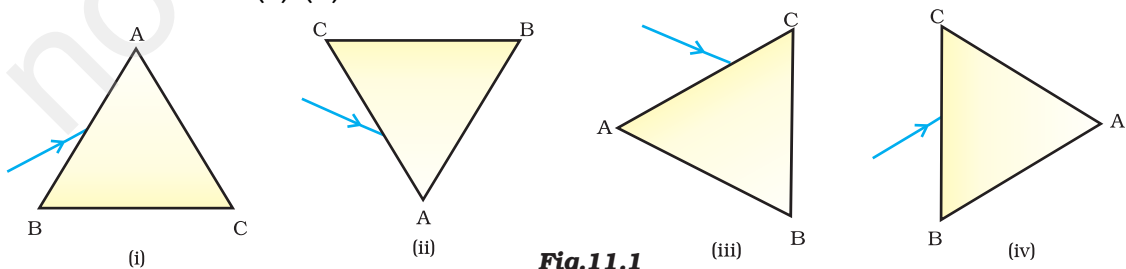

Fig.11.1

4. At noon the sun appears white as
- (a) light is least scattered
 - (b) all the colours of the white light are scattered away
 - (c) blue colour is scattered the most
 - (d) red colour is scattered the most
5. Which of the following phenomena of light are involved in the formation of a rainbow?
- (a) Reflection, refraction and dispersion
 - (b) Refraction, dispersion and total internal reflection
 - (c) Refraction, dispersion and internal reflection
 - (d) Dispersion, scattering and total internal reflection
6. Twinkling of stars is due to atmospheric
- (a) dispersion of light by water droplets
 - (b) refraction of light by different layers of varying refractive indices
 - (c) scattering of light by dust particles
 - (d) internal reflection of light by clouds
7. The clear sky appears blue because
- (a) blue light gets absorbed in the atmosphere
 - (b) ultraviolet radiations are absorbed in the atmosphere
 - (c) violet and blue lights get scattered more than lights of all other colours by the atmosphere
 - (d) light of all other colours is scattered more than the violet and blue colour lights by the atmosphere
8. Which of the following statements is correct regarding the propagation of light of different colours of white light in air?
- (a) Red light moves fastest
 - (b) Blue light moves faster than green light
 - (c) All the colours of the white light move with the same speed
 - (d) Yellow light moves with the mean speed as that of the red and the violet light
9. The danger signals installed at the top of tall buildings are red in colour. These can be easily seen from a distance because among all other colours, the red light
- (a) is scattered the most by smoke or fog
 - (b) is scattered the least by smoke or fog
 - (c) is absorbed the most by smoke or fog
 - (d) moves fastest in air

- 10.** Which of the following phenomena contributes significantly to the reddish appearance of the sun at sunrise or sunset?
- (a) Dispersion of light
 - (b) Scattering of light
 - (c) Total internal reflection of light
 - (d) Reflection of light from the earth
- 11.** The bluish colour of water in deep sea is due to
- (a) the presence of algae and other plants found in water
 - (b) reflection of sky in water
 - (c) scattering of light
 - (d) absorption of light by the sea
- 12.** When light rays enter the eye, most of the refraction occurs at the
- (a) crystalline lens
 - (b) outer surface of the cornea
 - (c) iris
 - (d) pupil
- 13.** The focal length of the eye lens increases when eye muscles
- (a) are relaxed and lens becomes thinner
 - (b) contract and lens becomes thicker
 - (c) are relaxed and lens becomes thicker
 - (d) contract and lens becomes thinner
- 14.** Which of the following statement is correct?
- (a) A person with myopia can see distant objects clearly
 - (b) A person with hypermetropia can see nearby objects clearly
 - (c) A person with myopia can see nearby objects clearly
 - (d) A person with hypermetropia cannot see distant objects clearly

Short Answer Questions

- 15.** Draw ray diagrams each showing (i) myopic eye and (ii) hypermetropic eye.
- 16.** A student sitting at the back of the classroom cannot read clearly the letters written on the blackboard. What advice will a doctor give to her? Draw ray diagram for the correction of this defect.
- 17.** How are we able to see nearby and also the distant objects clearly?

- 18.** A person needs a lens of power -4.5 D for correction of her vision.
- What kind of defect in vision is she suffering from?
 - What is the focal length of the corrective lens?
 - What is the nature of the corrective lens?
- 19.** How will you use two identical prisms so that a narrow beam of white light incident on one prism emerges out of the second prism as white light? Draw the diagram.
- 20.** Draw a ray diagram showing the dispersion through a prism when a narrow beam of white light is incident on one of its refracting surfaces. Also indicate the order of the colours of the spectrum obtained.
- 21.** Is the position of a star as seen by us its true position? Justify your answer.
- 22.** Why do we see a rainbow in the sky only after rainfall?
- 23.** Why is the colour of the clear sky blue?
- 24.** What is the difference in colours of the Sun observed during sunrise/sunset and noon? Give explanation for each.

Long Answer Questions

- 25.** Explain the structure and functioning of Human eye. How are we able to see nearby as well as distant objects?
- 26.** When do we consider a person to be myopic or hypermetropic? Explain using diagrams how the defects associated with myopic and hypermetropic eye can be corrected?
- 27.** Explain the refraction of light through a triangular glass prism using a labelled ray diagram. Hence define the angle of deviation.
- 28.** How can we explain the reddish appearance of sun at sunrise or sunset? Why does it not appear red at noon?
- 29.** Explain the phenomenon of dispersion of white light through a glass prism, using suitable ray diagram.
- 30.** How does refraction take place in the atmosphere? Why do stars twinkle but not the planets?

CHAPTER 12

Electricity

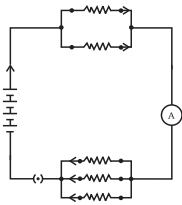

Multiple Choice Questions

1. A cell, a resistor, a key and ammeter are arranged as shown in the circuit diagrams of Figure 12.1. The current recorded in the ammeter will be

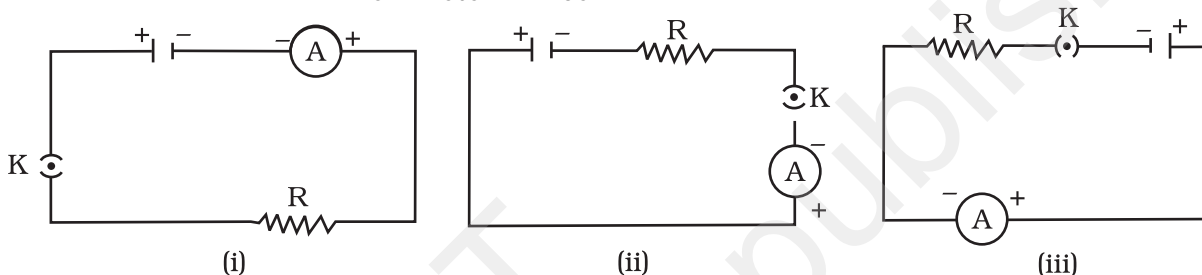

Fig. 12.1

- (a) maximum in (i)
 (b) maximum in (ii)
 (c) maximum in (iii)
 (d) the same in all the cases

2. In the following circuits (Figure 12.2), heat produced in the resistor or combination of resistors connected to a 12 V battery will be

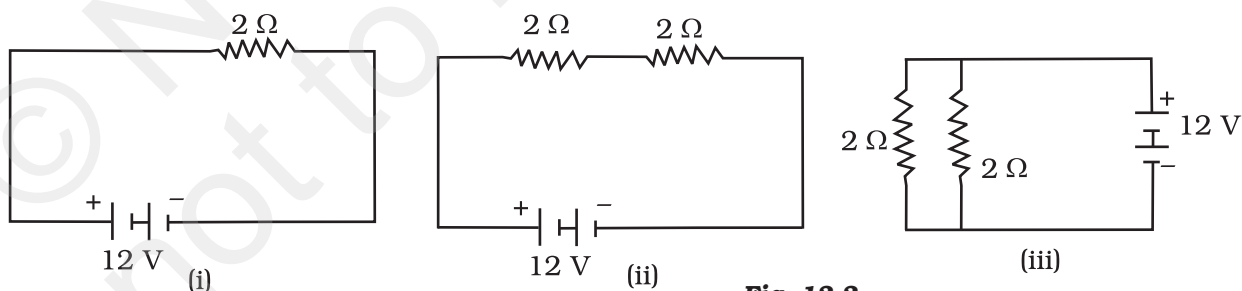

Fig. 12.2

- (a) same in all the cases
 (b) minimum in case (i)
 (c) maximum in case (ii)
 (d) maximum in case (iii)

3. Electrical resistivity of a given metallic wire depends upon
- its length
 - its thickness
 - its shape
 - nature of the material
4. A current of 1 A is drawn by a filament of an electric bulb. Number of electrons passing through a cross section of the filament in 16 seconds would be roughly
- 10^{20}
 - 10^{16}
 - 10^{18}
 - 10^{23}
5. Identify the circuit (Figure 12.3) in which the electrical components have been properly connected.

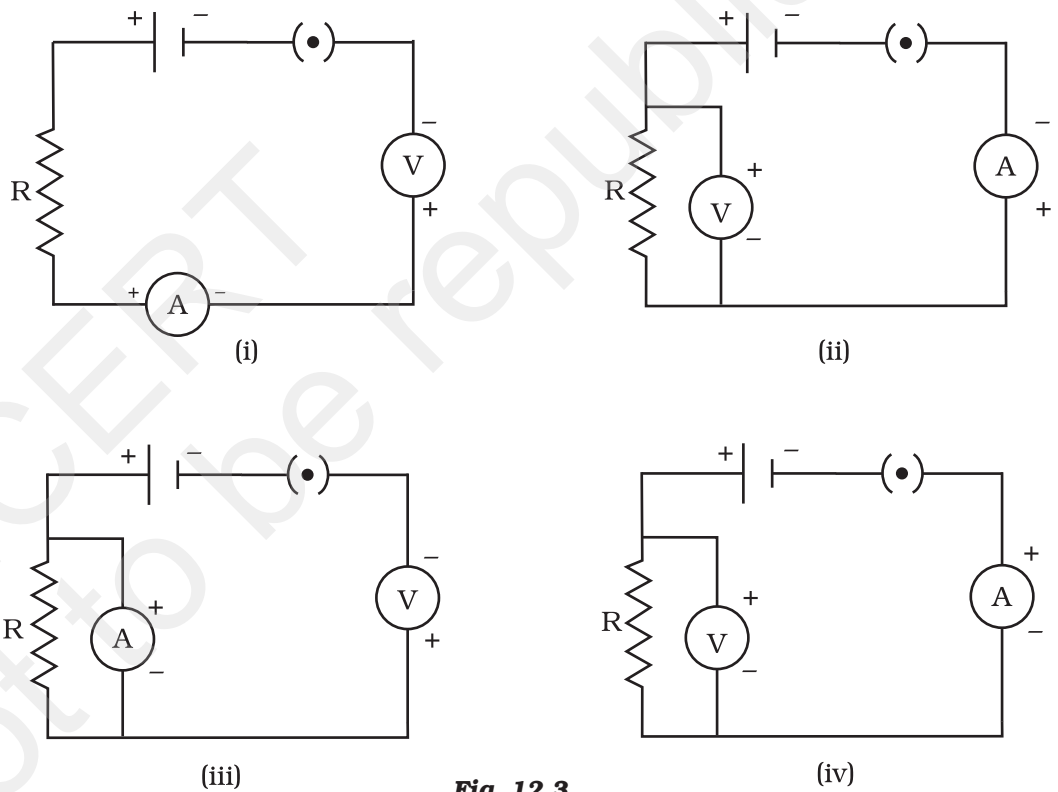

Fig. 12.3

- (i)
- (ii)
- (iii)
- (iv)

6. What is the maximum resistance which can be made using five resistors each of $1/5 \Omega$?
- (a) $1/5 \Omega$
 (b) 10Ω
 (c) 5Ω
 (d) 1Ω
7. What is the minimum resistance which can be made using five resistors each of $1/5 \Omega$?
- (a) $1/5 \Omega$
 (b) $1/25 \Omega$
 (c) $1/10 \Omega$
 (d) 25Ω
8. The proper representation of series combination of cells (Figure 12.4) obtaining maximum potential is

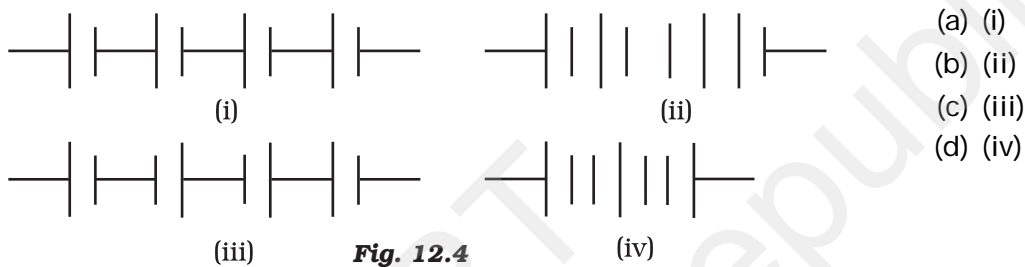

Fig. 12.4

9. Which of the following represents voltage?
- (a) $\frac{\text{Work done}}{\text{Current} \times \text{Time}}$
 (b) Work done Charge
 (c) $\frac{\text{Work done} \times \text{Time}}{\text{Current}}$
 (d) Work done Charge Time
10. A cylindrical conductor of length l and uniform area of cross-section A has resistance R . Another conductor of length $2l$ and resistance R of the same material has area of cross section
- (a) $A/2$
 (b) $3A/2$
 (c) $2A$
 (d) $3A$

11. A student carries out an experiment and plots the V-I graph of three samples of nichrome wire with resistances R_1 , R_2 and R_3 respectively (Figure.12.5). Which of the following is true?

- (a) $R_1 = R_2 = R_3$
- (b) $R_1 > R_2 > R_3$
- (c) $R_3 > R_2 > R_1$
- (d) $R_2 > R_3 > R_1$

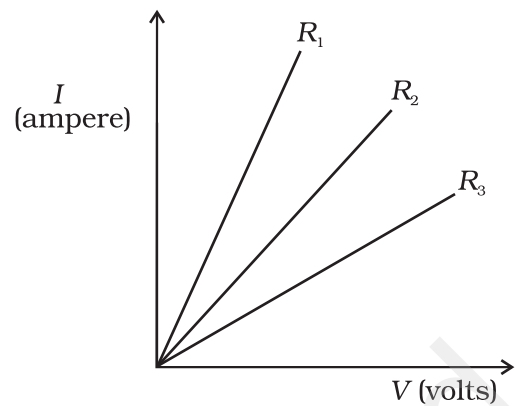

Fig. 12.5

12. If the current I through a resistor is increased by 100% (assume that temperature remains unchanged), the increase in power dissipated will be

- (a) 100 %
- (b) 200 %
- (c) 300 %
- (d) 400 %

13. The resistivity does not change if

- (a) the material is changed
- (b) the temperature is changed
- (c) the shape of the resistor is changed
- (d) both material and temperature are changed

14. In an electrical circuit three incandescent bulbs A, B and C of rating 40 W, 60 W and 100 W respectively are connected in parallel to an electric source. Which of the following is likely to happen regarding their brightness?

- (a) Brightness of all the bulbs will be the same
- (b) Brightness of bulb A will be the maximum
- (c) Brightness of bulb B will be more than that of A
- (d) Brightness of bulb C will be less than that of B

15. In an electrical circuit two resistors of 2Ω and 4Ω respectively are connected in series to a 6 V battery. The heat dissipated by the 4Ω resistor in 5 s will be

- (a) 5 J
- (b) 10 J
- (c) 20 J
- (d) 30 J

16. An electric kettle consumes 1 kW of electric power when operated at 220 V. A fuse wire of what rating must be used for it?

- (a) 1 A
- (b) 2 A
- (c) 4 A
- (d) 5 A

- 17.** Two resistors of resistance $2\ \Omega$ and $4\ \Omega$ when connected to a battery will have
- same current flowing through them when connected in parallel
 - same current flowing through them when connected in series
 - same potential difference across them when connected in series
 - different potential difference across them when connected in parallel
- 18.** Unit of electric power may also be expressed as
- volt ampere
 - kilowatt hour
 - watt second
 - joule second

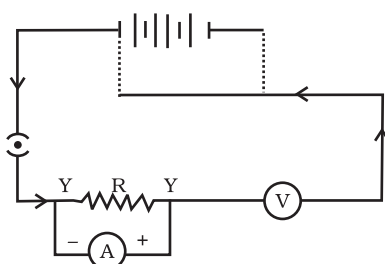

Fig. 12.6

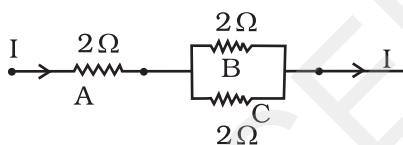

Fig. 12.7

Short Answer Questions

- 19.** A child has drawn the electric circuit to study Ohm's law as shown in Figure 12.6. His teacher told that the circuit diagram needs correction. Study the circuit diagram and redraw it after making all corrections.
- 20.** Three $2\ \Omega$ resistors, A, B and C, are connected as shown in Figure 12.7. Each of them dissipates energy and can withstand a maximum power of 18W without melting. Find the maximum current that can flow through the three resistors?
- 21.** Should the resistance of an ammeter be low or high? Give reason.

- 22.** Draw a circuit diagram of an electric circuit containing a cell, a key, an ammeter, a resistor of $2\ \Omega$ in series with a combination of two resistors ($4\ \Omega$ each) in parallel and a voltmeter across the parallel combination. Will the potential difference across the $2\ \Omega$ resistor be the same as that across the parallel combination of $4\ \Omega$ resistors? Give reason.
- 23.** How does use of a fuse wire protect electrical appliances?
- 24.** What is electrical resistivity? In a series electrical circuit comprising a resistor made up of a metallic wire, the ammeter reads $5\ \text{A}$. The reading of the ammeter decreases to half when the length of the wire is doubled. Why?

- 25.** What is the commercial unit of electrical energy? Represent it in terms of joules.
- 26.** A current of 1 ampere flows in a series circuit containing an electric lamp and a conductor of $5\ \Omega$ when connected to a 10 V battery. Calculate the resistance of the electric lamp.
- Now if a resistance of $10\ \Omega$ is connected in parallel with this series combination, what change (if any) in current flowing through $5\ \Omega$ conductor and potential difference across the lamp will take place? Give reason.
- 27.** Why is parallel arrangement used in domestic wiring?

- 28.** B_1 , B_2 and B_3 are three identical bulbs connected as shown in Figure 12.8. When all the three bulbs glow, a current of 3A is recorded by the ammeter A.

- (i) What happens to the glow of the other two bulbs when the bulb B_1 gets fused?
- (ii) What happens to the reading of A_1 , A_2 , A_3 and A when the bulb B_2 gets fused?
- (iii) How much power is dissipated in the circuit when all the three bulbs glow together?

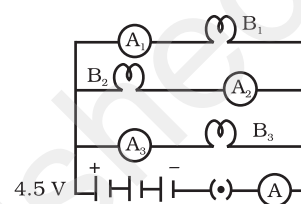

Fig. 12.8

Long Answer Questions

- 29.** Three incandescent bulbs of 100 W each are connected in series in an electric circuit. In another circuit another set of three bulbs of the same wattage are connected in parallel to the same source.
- (a) Will the bulb in the two circuits glow with the same brightness? Justify your answer.
- (b) Now let one bulb in both the circuits get fused. Will the rest of the bulbs continue to glow in each circuit? Give reason.
- 30.** State Ohm's law? How can it be verified experimentally? Does it hold good under all conditions? Comment.
- 31.** What is electrical resistivity of a material? What is its unit? Describe an experiment to study the factors on which the resistance of conducting wire depends.
- 32.** How will you infer with the help of an experiment that the same current flows through every part of the circuit containing three resistances in series connected to a battery?
- 33.** How will you conclude that the same potential difference (voltage) exists across three resistors connected in a parallel arrangement to a battery?

- 34.** What is Joule's heating effect? How can it be demonstrated experimentally? List its four applications in daily life.
- 35.** Find out the following in the electric circuit given in Figure 12.9
- Effective resistance of two $8\ \Omega$ resistors in the combination
 - Current flowing through $4\ \Omega$ resistor
 - Potential difference across $4\ \Omega$ resistance
 - Power dissipated in $4\ \Omega$ resistor
 - Difference in ammeter readings, if any.

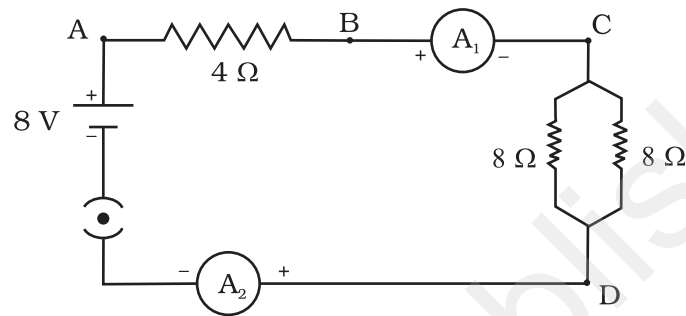
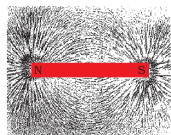

Fig. 12.9

CHAPTER 13

Magnetic Effects of Electric Current



Multiple Choice Questions

1. Choose the incorrect statement from the following regarding magnetic lines of field

- (a) The direction of magnetic field at a point is taken to be the direction in which the north pole of a magnetic compass needle points
- (b) Magnetic field lines are closed curves
- (c) If magnetic field lines are parallel and equidistant, they represent zero field strength
- (d) Relative strength of magnetic field is shown by the degree of closeness of the field lines

2. If the key in the arrangement (Figure 13.1) is taken out (the circuit is made open) and magnetic field lines are drawn over the horizontal plane ABCD, the lines are

- (a) concentric circles
- (b) elliptical in shape
- (c) straight lines parallel to each other
- (d) concentric circles near the point O but of elliptical shapes as we go away from it

3. A circular loop placed in a plane perpendicular to the plane of paper carries a current when the key is ON. The current as seen from points A and B (in the plane of paper and on the axis of the coil) is anti clockwise and clockwise respectively. The magnetic field lines point from B to A. The N-pole of the resultant magnet is on the face close to

- (a) A
- (b) B
- (c) A if the current is small, and B if the current is large
- (d) B if the current is small and A if the current is large

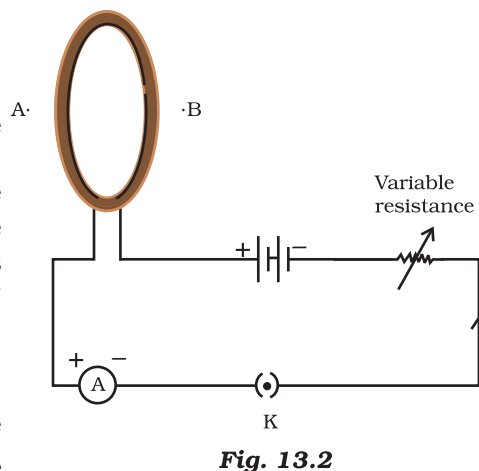
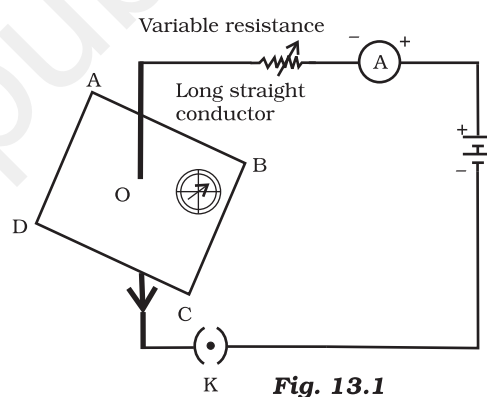

4. For a current in a long straight solenoid N- and S-poles are created at the two ends. Among the following statements, the incorrect statement is
- The field lines inside the solenoid are in the form of straight lines which indicates that the magnetic field is the same at all points inside the solenoid
 - The strong magnetic field produced inside the solenoid can be used to magnetise a piece of magnetic material like soft iron, when placed inside the coil
 - The pattern of the magnetic field associated with the solenoid is different from the pattern of the magnetic field around a bar magnet
 - The N- and S-poles exchange position when the direction of current through the solenoid is reversed

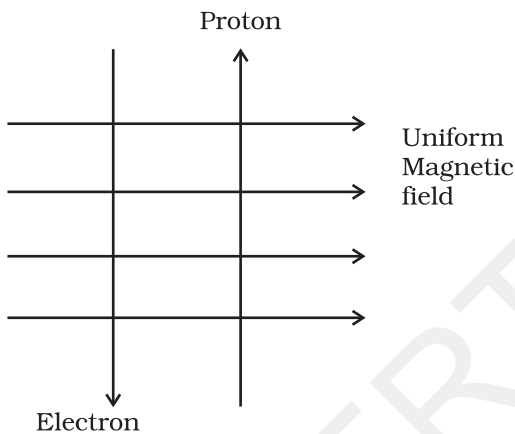

Fig. 13.3

5. A uniform magnetic field exists in the plane of paper pointing from left to right as shown in Figure 13.3. In the field an electron and a proton move as shown. The electron and the proton experience

- forces both pointing into the plane of paper
- forces both pointing out of the plane of paper
- forces pointing into the plane of paper and out of the plane of paper, respectively
- force pointing opposite and along the direction of the uniform magnetic field respectively

6. Commercial electric motors do not use

- an electromagnet to rotate the armature
- effectively large number of turns of conducting wire in the current carrying coil
- a permanent magnet to rotate the armature
- a soft iron core on which the coil is wound

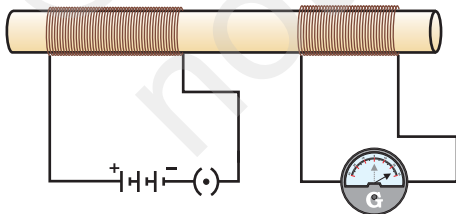

Fig. 13.4

7. In the arrangement shown in Figure 13.4 there are two coils wound on a non-conducting cylindrical rod. Initially the key is not inserted. Then the key is inserted and later removed. Then

- the deflection in the galvanometer remains zero throughout
- there is a momentary deflection in the galvanometer but it dies out shortly and there is no effect when the key is removed

- (c) there are momentary galvanometer deflections that die out shortly; the deflections are in the same direction
- (d) there are momentary galvanometer deflections that die out shortly; the deflections are in opposite directions
- 8.** Choose the incorrect statement
- (a) Fleming's right-hand rule is a simple rule to know the direction of induced current
- (b) The right-hand thumb rule is used to find the direction of magnetic fields due to current carrying conductors
- (c) The difference between the direct and alternating currents is that the direct current always flows in one direction, whereas the alternating current reverses its direction periodically
- (d) In India, the AC changes direction after every $\frac{1}{50}$ second
- 9.** A constant current flows in a horizontal wire in the plane of the paper from east to west as shown in Figure 13.5. The direction of magnetic field at a point will be North to South
- (a) directly above the wire
- (b) directly below the wire
- (c) at a point located in the plane of the paper, on the north side of the wire
- (d) at a point located in the plane of the paper, on the south side of the wire
- 10.** The strength of magnetic field inside a long current carrying straight solenoid is
- (a) more at the ends than at the centre
- (b) minimum in the middle
- (c) same at all points
- (d) found to increase from one end to the other
- 11.** To convert an AC generator into DC generator
- (a) split-ring type commutator must be used
- (b) slip rings and brushes must be used
- (c) a stronger magnetic field has to be used
- (d) a rectangular wire loop has to be used
- 12.** The most important safety method used for protecting home appliances from short circuiting or overloading is
- (a) earthing
- (b) use of fuse
- (c) use of stabilizers
- (d) use of electric meter

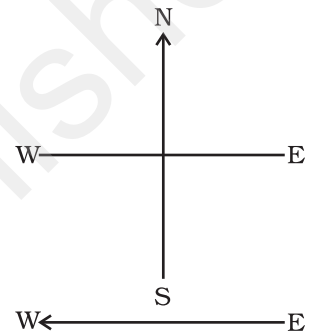

Fig. 13.5

Short Answer Questions

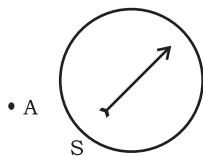

Fig. 13.6

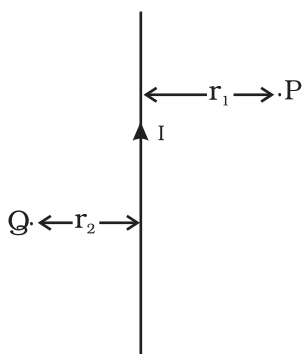

Fig. 13.7

- 13.** A magnetic compass needle is placed in the plane of paper near point A as shown in Figure 13.6. In which plane should a straight current carrying conductor be placed so that it passes through A and there is no change in the deflection of the compass? Under what condition is the deflection maximum and why?
- 14.** Under what conditions permanent electromagnet is obtained if a current carrying solenoid is used? Support your answer with the help of a labelled circuit diagram.
- 15.** AB is a current carrying conductor **in** the plane of the paper as shown in Figure 13.7. What are the directions of magnetic fields produced by it at points P and Q? Given $r_1 > r_2$, where will the strength of the magnetic field be larger?
- 16.** A magnetic compass shows a deflection when placed near a current carrying wire. How will the deflection of the compass get affected if the current in the wire is increased? Support your answer with a reason.
- 17.** It is established that an electric current through a metallic conductor produces a magnetic field around it. Is there a similar magnetic field produced around a thin beam of moving (i) alpha particles, (ii) neutrons? Justify your answer.
- 18.** What does the direction of thumb indicate in the right-hand thumb rule. In what way this rule is different from Fleming's left-hand rule?
- 19.** Meena draws magnetic field lines of field close to the axis of a current carrying circular loop. As she moves away from the centre of the circular loop she observes that the lines keep on diverging. How will you explain her observation.
- 20.** What does the divergence of magnetic field lines near the ends of a current carrying straight solenoid indicate?
- 21.** Name four appliances wherein an electric motor, a rotating device that converts electrical energy to mechanical energy, is used as an important component. In what respect motors are different from generators?
- 22.** What is the role of the two conducting stationary brushes in a simple electric motor?
- 23.** What is the difference between a direct current and an alternating current? How many times does AC used in India change direction in one second?

- 24.** What is the role of fuse, used in series with any electrical appliance? Why should a fuse with defined rating not be replaced by one with a larger rating?

Long Answer Questions

- 25.** Why does a magnetic compass needle pointing North and South in the absence of a nearby magnet get deflected when a bar magnet or a current carrying loop is brought near it. Describe some salient features of magnetic lines of field concept.
- 26.** With the help of a labelled circuit diagram illustrate the pattern of field lines of the magnetic field around a current carrying straight long conducting wire. How is the right hand thumb rule useful to find direction of magnetic field associated with a current carrying conductor?
- 27.** Explain with the help of a labelled diagram the distribution of magnetic field due to a current through a circular loop. Why is it that if a current carrying coil has n turns the field produced at any point is n times as large as that produced by a single turn?
- 28.** Describe the activity that shows that a current-carrying conductor experiences a force perpendicular to its length and the external magnetic field. How does Fleming's left-hand rule help us to find the direction of the force acting on the current carrying conductor?
- 29.** Draw a labelled circuit diagram of a simple electric motor and explain its working. In what way these simple electric motors are different from commercial motors?
- 30.** Explain the phenomenon of electromagnetic induction. Describe an experiment to show that a current is set up in a closed loop when an external magnetic field passing through the loop increases or decreases.
- 31.** Describe the working of an AC generator with the help of a labelled circuit diagram. What changes must be made in the arrangement to convert it to a DC generator?
- 32.** Draw an appropriate schematic diagram showing common domestic circuits and discuss the importance of fuse. Why is it that a burnt out fuse should be replaced by another fuse of identical rating?

CHAPTER 14

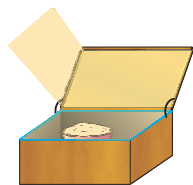

Sources of Energy

Multiple Choice Questions

1. Which of the following is a non-renewable source of energy?
 - (a) Wood
 - (b) Sun
 - (c) Fossil fuels
 - (d) Wind
2. Acid rain happens because
 - (a) sun leads to heating of upper layer of atmosphere
 - (b) burning of fossil fuels release oxides of carbon, nitrogen and sulphur in the atmosphere
 - (c) electrical charges are produced due to friction amongst clouds
 - (d) earth atmosphere contains acids
3. Fuel used in thermal power plants is
 - (a) water
 - (b) uranium
 - (c) biomass
 - (d) fossil fuels
4. In a hydro power plant
 - (a) Potential energy possessed by stored water is converted into electricity
 - (b) Kinetic energy possessed by stored water is converted into potential energy
 - (c) Electricity is extracted from water
 - (d) Water is converted into steam to produce electricity

- 5.** Which is the ultimate source of energy?
- (a) Water
 - (b) Sun
 - (c) Uranium
 - (d) Fossil fuels
- 6.** Which one of the following forms of energy leads to least environmental pollution in the process of its harnessing and utilisation?
- (a) Nuclear energy
 - (b) Thermal energy
 - (c) Solar energy
 - (d) Geothermal energy
- 7.** Ocean thermal energy is due to
- (a) energy stored by waves in the ocean
 - (b) temperature difference at different levels in the ocean
 - (c) pressure difference at different levels in the ocean
 - (d) tides arising out in the ocean
- 8.** The major problem in harnessing nuclear energy is how to
- (a) split nuclei?
 - (b) sustain the reaction?
 - (c) dispose off spent fuel safely?
 - (d) convert nuclear energy into electrical energy?
- 9.** Which part of the solar cooker is responsible for green house effect?
- (a) Coating with black colour inside the box
 - (b) Mirror
 - (c) Glass sheet
 - (d) Outer cover of the solar cooker
- 10.** The main constituent of biogas is
- (a) methane
 - (b) carbon dioxide
 - (c) hydrogen
 - (d) hydrogen sulphide
- 11.** The power generated in a windmill
- (a) is more in rainy season since damp air would mean more air mass hitting the blades
 - (b) depends on the height of the tower
 - (c) depends on wind velocity
 - (d) can be increased by planting tall trees close to the tower

- 12.** Choose the correct statement
- (a) Sun can be taken as an inexhaustible source of energy
 - (b) There is infinite storage of fossil fuel inside the earth
 - (c) Hydro and wind energy plants are non polluting sources of energy
 - (d) Waste from a nuclear power plant can be easily disposed off
- 13.** In a hydroelectric power plant more electrical power can be generated if water falls from a greater height because
- (a) its temperature increases
 - (b) larger amount of potential energy is converted into kinetic energy
 - (c) the electricity content of water increases with height
 - (d) more water molecules dissociate into ions
- 14.** Choose the incorrect statement regarding wind power
- (a) It is expected to harness wind power to minimum in open space
 - (b) The potential energy content of wind blowing at high altitudes is the source of wind power
 - (c) Wind hitting at the blades of a windmill causes them to rotate. The rotation thus achieved can be utilised further
 - (d) One possible method of utilising the energy of rotational motion of the blades of a windmill is to run the turbine of an electric generator
- 15.** Choose the incorrect statement
- (a) We are encouraged to plant more trees so as to ensure clean environment and also provide bio-mass fuel
 - (b) Gobar-gas is produced when crops, vegetable wastes etc., decompose in the absence of oxygen
 - (c) The main ingredient of bio-gas is ethane and it gives a lot of smoke and also produces a lot of residual ash
 - (d) Bio-mass is a renewable source of energy

Short Answer Questions

- 16.** Why is there a need to harness non-conventional sources of energy? Give two main reasons.
- 17.** Write two different ways of harnessing energy from ocean.
- 18.** What steps would you suggest to minimise environmental pollution caused by burning of fossil fuels?

19. What is the role of a plane mirror and a glass sheet in a solar cooker?
20. Mention three advantages of a solar cell?
21. What is biomass? What can be done to obtain bio-energy using biomass?
22. What are the limitations in obtaining energy from wind?

Long Answer Questions

23. Which is the process used to harness nuclear energy these days? Explain it briefly.
24. How can solar energy be harnessed? Mention any two limitations in using solar energy. How are these limitations overcome?
25. Make a list of conventional and non-conventional sources of energy. Give a brief description of harnessing one non-conventional source of energy.
26. Why is there a need for harnessing non-conventional sources of energy? How can energy be harnessed from the sea in different ways?
27. What are the environmental consequences of using fossil fuels? Suggest the steps to minimise the pollution caused by various sources of energy including non-conventional sources of energy.
28. Energy from various sources is considered to have been derived from the sun. Do you agree? Justify your answer.
29. What is biomass? Explain the principle and working of a biogas plant using a labelled schematic diagram.

CHAPTER 15



Our Environment

Multiple Choice Questions

- Which one of the following is an artificial ecosystem?
 - Pond
 - Crop field
 - Lake
 - Forest
- In a food chain, the third trophic level is always occupied by
 - carnivores
 - herbivores
 - decomposers
 - producers
- An ecosystem includes
 - all living organisms
 - non-living objects
 - both living organisms and non-living objects
 - sometimes living organisms and sometimes non-living objects
- In the given food chain, suppose the amount of energy at fourth trophic level is 5 kJ, what will be the energy available at the producer level?
Grass → Grasshopper → Frog → Snake → Hawk
 - 5 k J
 - 50 k J
 - 500 k J
 - 5000 k J
- Accumulation of non-biodegradable pesticides in the food chain in increasing amount at each higher trophic level is known as
 - eutrophication
 - pollution
 - biomagnification
 - accumulation

- 6.** Depletion of ozone is mainly due to
- (a) chlorofluorocarbon compounds
 - (b) carbon monoxide
 - (c) methane
 - (d) pesticides
- 7.** Organisms which synthesise carbohydrates from inorganic compounds using radiant energy are called
- (a) decomposers
 - (b) producers
 - (c) herbivores
 - (d) carnivores
- 8.** In an ecosystem, the 10% of energy available for transfer from one trophic level to the next is in the form of
- (a) heat energy
 - (b) light energy
 - (c) chemical energy
 - (d) mechanical energy
- 9.** Organisms of a higher trophic level which feed on several types of organisms belonging to a lower trophic level constitute the
- (a) food web
 - (b) ecological pyramid
 - (c) ecosystem
 - (d) food chain
- 10.** Flow of energy in an ecosystem is always
- (a) unidirectional
 - (b) bidirectional
 - (c) multi directional
 - (d) no specific direction
- 11.** Excessive exposure of humans to U V-rays results in
- (i) damage to immune system
 - (ii) damage to lungs
 - (iii) skin cancer
 - (iv) peptic ulcers
- (a) (i) and (ii)
 - (b) (ii) and (iv)
 - (c) (i) and (iii)
 - (d) (iii) and (iv)

- 12.** In the following groups of materials, which group (s) contains only non-biodegradable items?
- (i) Wood, paper, leather
 - (ii) Polythene, detergent, PVC
 - (iii) Plastic, detergent, grass
 - (iv) Plastic, bakelite, DDT
- (a) (iii) (b) (iv)
 - (c) (i) and (iii) (d) (ii) and (iv)
- 13.** Which of the following limits the number of trophic levels in a food chain?
- (a) Decrease in energy at higher trophic levels
 - (b) Dufficient food supply
 - (c) Polluted air
 - (d) Water
- 14.** Which of the statement is incorrect?
- (a) All green plants and blue green algae are producers
 - (b) Green plants get their food from organic compounds
 - (c) Producers prepare their own food from inorganic compounds
 - (d) Plants convert solar energy into chemical energy
- 15.** Which group of organisms are not constituents of a food chain?
- (i) Grass, lion, rabbit, wolf
 - (ii) Plankton, man, fish, grasshopper
 - (iii) Wolf, grass, snake, tiger
 - (iv) Frog, snake, eagle, grass, grasshopper
- (a) (i) and (iii) (b) (iii) and (iv)
 - (c) (ii) and (iii) (d) (i) and (iv)
- 16.** The percentage of solar radiation absorbed by all the green plants for the process of photosynthesis is about
- (a) 1 %
 - (b) 5 %
 - (c) 8 %
 - (d) 10 %

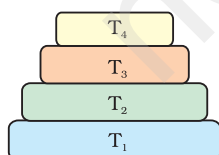

Fig. 15.1

- 17.** In the given Figure 15.1 the various trophic levels are shown in a pyramid. At which trophic level is maximum energy available?
- (a) T_4
 - (b) T_2
 - (c) T_1
 - (d) T_3

18. What will happen if deer is missing in the food chain given below?

Grass → Deer → Tiger

- (a) The population of tiger increases
- (b) The population of grass decreases
- (c) Tiger will start eating grass
- (d) The population of tiger decreases and the population of grass increases

19. The decomposers in an ecosystem

- (a) convert inorganic material, to simpler forms
- (b) convert organic material to inorganic forms
- (c) convert inorganic materials into organic compounds
- (d) do not breakdown organic compounds

20. If a grass hopper is eaten by a frog, then the energy transfer will be from

- (a) producer to decomposer
- (b) producer to primary consumer
- (c) primary consumer to secondary consumer
- (d) secondary consumer to primary consumer

21. Disposable plastic plates should not be used because

- (a) they are made of materials with light weight
- (b) they are made of toxic materials
- (c) they are made of biodegradable materials
- (d) they are made of non-biodegradable materials

Short Answer Questions

22. Why is improper disposal of waste a curse to environment?

23. Write the common food chain of a pond ecosystem.

24. What are the advantages of cloth bags over plastic bags during shopping?

25. Why are crop fields known as artificial ecosystems?

26. Differentiate between biodegradable and non-biodegradable substances. Cite examples.

- 27.** Suggest one word for each of the following statements/ definitions
- (a) The physical and biological world where we live in
 - (b) Each level of food chain where transfer of energy takes place
 - (c) The physical factors like temperature, rainfall, wind and soil of an ecosystem
 - (d) Organisms which depend on the producers either directly or indirectly for food
- 28.** Explain the role of decomposers in the environment?
- 29.** Select the mis-matched pair in the following and correct it.
- (a) Biomagnification — Accumulation of chemicals at the successive trophic levels of a food chain
 - (b) Ecosystem — Biotic components of environment
 - (c) Aquarium — A man-made ecosystem
 - (d) Parasites — Organisms which obtain food from other living organisms
- 30.** We do not clean ponds or lakes, but an aquarium needs to be cleaned. Why?

Long Answer Questions

- 31.** Indicate the flow of energy in an ecosystem. Why is it unidirectional? Justify.
- 32.** What are decomposers? What will be the consequence of their absence in an ecosystem?
- 33.** Suggest any four activities in daily life which are eco-friendly.
- 34.** Give two differences between food chain and food web.
- 35.** Name the wastes which are generated in your house daily. What measures would you take for their disposal?
- 36.** Suggest suitable mechanism (s) for waste management in fertiliser industries.
- 37.** What are the by-products of fertiliser industries? How do they affect the environment?
- 38.** Explain some harmful effects of agricultural practices on the environment.

CHAPTER 16

Management of Natural Resources



Multiple Choice Questions

1. From the list given below pick the item that is not a natural resource
 - (a) Soil
 - (b) Water
 - (c) Electricity
 - (d) Air
2. The most rapidly dwindling natural resource in the world is
 - (a) water
 - (b) forests
 - (c) wind
 - (d) sunlight
3. The most appropriate definition of a natural resource is that it is a substance/commodity that is
 - (a) present only on land
 - (b) a gift of nature which is very useful to mankind
 - (c) a man-made substance placed in nature
 - (d) available only in the forest
4. The main cause for abundant coliform bacteria in the river Ganga is
 - (a) disposal of unburnt corpses into water
 - (b) discharge of effluents from electroplating industries
 - (c) washing of clothes
 - (d) immersion of ashes
5. The pH of water sample collected from a river was found to be acidic in the range of 3.5 – 4.5, on the banks of the river were several factories that were discharging effluents into the river. The effluents of which one of the following factories is the most likely cause for lowering the pH of river water?
 - (a) Soap and detergent factory
 - (b) Lead battery manufacturing factory
 - (c) Plastic cup manufacturing factory
 - (d) Alcohol distillery

- 6.** The pH range most conducive for life of fresh water plants and animals is
- (a) 6.5 – 7.5
 - (b) 2.0 – 3.5
 - (c) 3.5 – 5.0
 - (d) 9.0 – 10.5
- 7.** The three R's that will help us to conserve natural resources for long term use are
- (a) recycle, regenerate, reuse
 - (b) reduce, regenerate, reuse
 - (c) reduce, reuse, redistribute
 - (d) reduce, recycle, reuse
- 8.** Given below are a few statements related to biodiversity. Pick those that correctly describe the concept of biodiversity
- (i) Biodiversity refers to the different species of flora and fauna present in an area
 - (ii) Biodiversity refers to only the flora of a given area
 - (iii) Biodiversity is greater in a forest
 - (iv) Biodiversity refers to the total number of individuals of a particular species living in an area
- (a) (i) and (ii)
 - (b) (ii) and (iv)
 - (c) (i) and (iii)
 - (d) (ii) and (iii)
- 9.** Among the statements given below select the ones that correctly describe the concept of sustainable development
- (i) Planned growth with minimum damage to the environment
 - (ii) Growth irrespective of the extent of damage caused to the environment
 - (iii) Stopping all developmental work to conserve the environment
 - (iv) Growth that is acceptable to all the stakeholders
- (a) (i) and (iv)
 - (b) (ii) and (iii)
 - (c) (ii) and (iv)
 - (d) (iii) only
- 10.** In our country, vast tracts of forests are cleared and a single species of plant is cultivated. This practice promotes
- (a) biodiversity in the area
 - (b) monoculture in the area
 - (c) growth of natural forest
 - (d) preserves the natural ecosystem in the area

- 11.** A successful forest conservation strategy should involve
- (a) protection of animals at the highest trophic level
 - (b) protection of only consumers
 - (c) protection of only herbivores
 - (d) comprehensive programme to protect all the physical and biological components
- 12.** The important message conveyed by the 'Chipko Movement' is
- (a) to involve the community in forest conservation efforts
 - (b) to ignore the community in forest conservation efforts
 - (c) to cut down forest trees for developmental activities
 - (d) government agencies have the unquestionable right to order destruction of trees in forests
- 13.** In our country, there are attempts to increase the height of several existing dams like Tehri and Almati, dams across Narmada. Choose the correct statements among the following that are a consequence of raising the height of dams
- (i) Terrestrial flora and fauna of the area is destroyed completely
 - (ii) Dislocation of people and domestic animals living in the area
 - (iii) Valuable agricultural land may be permanently lost
 - (iv) It will generate permanent employment for people
- (a) (i) and (ii)
 - (b) (i), (ii) and (iii)
 - (c) (ii) and (iv)
 - (d) (i), (iii) and (iv)
- 14.** Expand the abbreviation GAP
- (a) Governmental Agency for Pollution Control
 - (b) Gross Assimilation by Photosynthesis
 - (c) Ganga Action Plan
 - (d) Governmental Agency for Animal Protection
- 15.** Select the incorrect statement
- (a) Economic development is linked to environmental conservation
 - (b) Sustainable development encourages development for current generation and conservation of resources for future generations
 - (c) Sustainable development does not consider the view points of stakeholders
 - (d) Sustainable development is a long planned and persistent development
- 16.** Which of the following is not a natural resource?
- (a) Mango tree
 - (b) Snake
 - (c) Wind
 - (d) Wooden house

- 17.** Select the wrong statement
- (a) Forests provide variety of products
 - (b) Forests have greater plant diversity
 - (c) Forests do not conserve soil
 - (d) Forests conserve water
- 18.** Arabari forests of Bengal is dominated by
- (a) Teak
 - (b) Sal
 - (c) Bamboo
 - (d) Mangroove
- 19.** Ground water will not be depleted due to
- (a) afforestation
 - (b) thermal power plants
 - (c) loss of forest, and decreased rainfall
 - (d) cropping of high water demanding crops
- 20.** Opposition to the construction of large dams is due to
- (a) social reasons
 - (b) economic reasons
 - (c) enviromental reasons
 - (d) all the above
- 21.** Khadins, Bundhis, Ahars and Kattas are ancient structures that are examples for
- (a) grain storage
 - (b) wood storage
 - (c) water harvesting
 - (d) soil conservation
- 22.** Pick the right combination of terms which has no fossil fuel.
- (a) Wind, ocean and coal
 - (b) Kerosene, wind and tide
 - (c) Wind, wood, sun
 - (d) Petroleum, wood, sun
- 23.** Select the eco-friendly activity among the following
- (a) Using car for transportation
 - (b) Using polybags for shopping
 - (c) Using dyes for colouring clothes
 - (d) Using windmills to generate power for irrigation

- 24.** It is important to make small check dams across the flooded gullies because they
- (i) hold water for irrigation
 - (ii) hold water and prevent soil erosion
 - (iii) recharge ground water
 - (iv) hold water permanently
- (a) (i) and (iv) (b) (ii) and (iii)
(c) (iii) and (iv) (d) (ii) and (iv)

Short Answer Questions

- 25.** Prepare a list of five items that you use daily in the school. Identify from the list such items that can be recycled.
- 26.** List two advantages associated with water harvesting at the community level.
- 27.** In a village in Karnataka, people started cultivating crops all around a lake which was always filled with water. They added fertilisers to their field in order to enhance the yield. Soon they discovered that the waterbody was completely covered with green floating plants and fishes started dying in large numbers.
- Analyse the situation and give reasons for excessive growth of plants and death of fish in the lake.
- 28.** What measures would you take to conserve electricity in your house?
- 29.** Although coal and petroleum are produced by degradation of bio-mass, yet we need to conserve them. Why?
- 30.** Suggest a few measures for controlling carbon dioxide levels in the atmosphere.
- 31.** (a) Locate and name the water reservoirs in Figures 16.1 (a) and (b).
(b) Which has an advantage over the other and why?

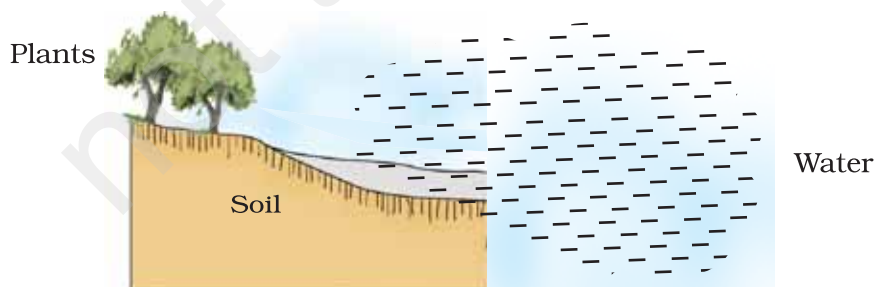

Fig. 16.1 (a)

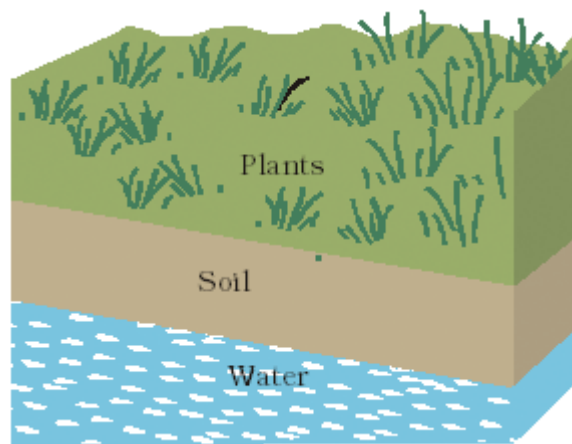

Fig. 16.1 (b)

Long Answer Questions

- 32.** In the context of conservation of natural resources, explain the terms reduce, recycle and reuse. From among the materials that we use in daily life, identify two materials for each category.
- 33.** Prepare a list of five activities that you perform daily in which natural resources can be conserved or energy utilisation can be minimised.
- 34.** Is water conservation necessary? Give reasons.
- 35.** Suggest a few useful ways of utilising waste water.
- 36.** What is the importance of forest as a resource?
- 37.** Why are the Arabari forests of Bengal known to be a good example of conserved forest?

SCIENCE
CLASS X (THEORY)
SAMPLE QUESTION PAPER-I

Time : 3 Hours

Maximum Marks : 75

Multiple Choice Questions

- 1.** Solid calcium oxide reacts vigorously with water to form calcium hydroxide accompanied by liberation of heat. This process is called slaking of lime. Which among the following is (are) true about slaking of lime?
- (i) It is an endothermic reaction
 - (ii) It is an exothermic reaction
 - (iii) The pH of the resulting solution will be more than seven
 - (iv) The pH of the resulting solution will be less than seven
- (a) (i) and (ii)
 - (b) (ii) and (iii)
 - (c) (i) and (iv)
 - (d) (iii) and (iv) (1)
- 2.** Sodium carbonate is a basic salt because it is a salt of
- (a) strong acid and strong base
 - (b) weak acid and weak base
 - (c) weak base and strong acid
 - (d) strong base and weak acid (1)
- 3.** Which one of the following four metals would be displaced from the solution of its salt by other three metals?
- (a) Mg
 - (b) Ag
 - (c) Zn
 - (d) Cu (1)
- 4.** Which one among the following is the correct representation of electron dot structure of nitrogen
- (a) $\cdot\ddot{N} : \ddot{N} \cdot$
 - (b) $\cdot\ddot{N} :: \ddot{N} \cdot$
 - (c) $\cdot\ddot{N} : \ddot{N} \cdot$
 - (d) $\cdot\ddot{N} :: \ddot{N} \cdot$ (1)

5. The correct sequence of anaerobic reactions in yeast is

- (a) Glucose $\xrightarrow{\text{cytoplasm}}$ Pyruvate $\xrightarrow{\text{mitochondria}}$ Ethanol + Carbondioxide
 - (b) Glucose $\xrightarrow{\text{cytoplasm}}$ Pyruvate $\xrightarrow{\text{cytoplasm}}$ Lactic acid
 - (c) Glucose $\xrightarrow{\text{cytoplasm}}$ Pyruvate $\xrightarrow{\text{mitochondria}}$ Lactic acid
 - (d) Glucose $\xrightarrow{\text{cytoplasm}}$ Pyruvate $\xrightarrow{\text{cytoplasm}}$ Ethanol + Carbondioxide
- (1)

6. Offspring formed as a result of sexual reproduction exhibit more variations because

- (a) sexual reproduction is a lengthy process
 - (b) genetic material comes from two parents of the same species
 - (c) genetic material comes from two parents of different species
 - (d) genetic material comes from many parents
- (1)

7. New species may be formed if

- (i) DNA undergoes significant changes in germ cells
- (ii) chromosome number changes in the gamete
- (iii) chromosome number remains the same
- (iv) mating does not take place

- (a) (i) and (ii)
 - (b) (i) and (iii)
 - (c) (ii), (iii) and (iv)
 - (d) (i), (ii) and (iv)
- (1)

8. Beams of light are incident through the holes A and B and emerge out of the box through the holes C and D respectively as shown in the Figure. Which of the following could be inside the box?

- (a) a rectangular glass slab
 - (b) a convex lens
 - (c) a concave lens
 - (d) a glass prism
- (1)

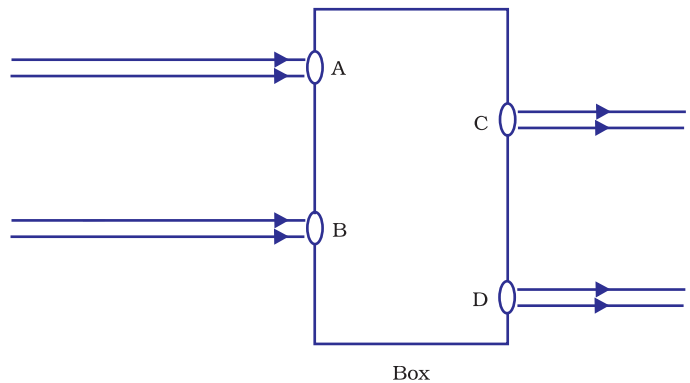

9. The clear sky appears blue because

- (a) blue light gets absorbed in the atmosphere.
- (b) ultraviolet radiations are absorbed in the atmosphere.
- (c) violet and blue lights get scattered more than all other colours by the atmosphere.
- (d) light of all other colours is scattered more than the violet and blue colour lights by the atmosphere. (1)

10. Identify the given circuit in which the electrical components have been properly connected.

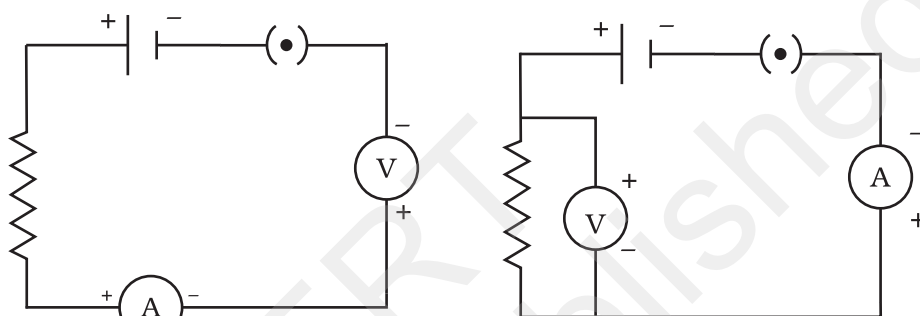

(i)

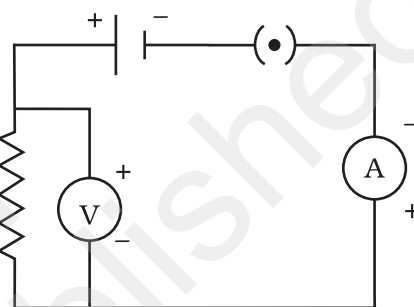

(ii)

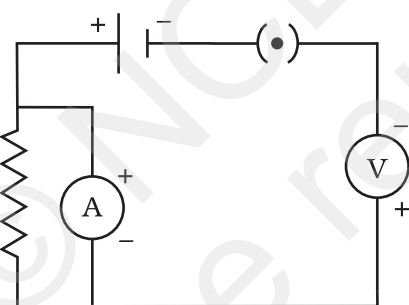

(iii)

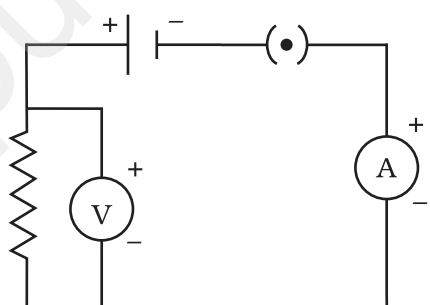

(iv)

(a) (i)

(b) (ii)

(c) (iii)

(d) (iv)

(1)

11. The resistance between A and B in the given Figure will be

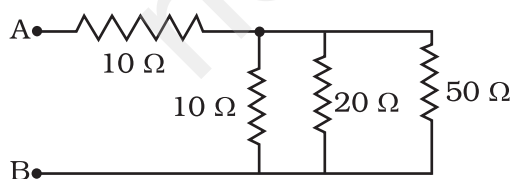

(a) 20 Ω

(b) 30 Ω

(c) 90 Ω

(d) more than 10 Ω but less than 20 Ω (1)

12. In the arrangement shown in given Figure, there are two coils wound on a non-conducting cylindrical rod. Initially the key is not inserted. Then the key is inserted and later removed. Then

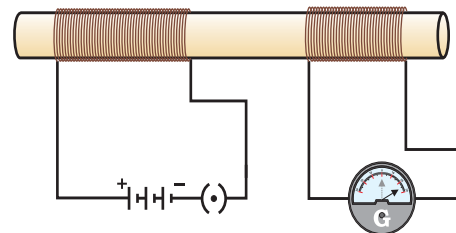

- (a) the deflection in the galvanometer remains zero throughout
- (b) there is a momentary deflection in the galvanometer but it dies out shortly and there is no effect when the key is removed
- (c) there are momentary galvanometer deflections that die out shortly; the deflections are in the same direction
- (d) there are momentary galvanometer deflections that die out shortly; the deflections are in opposite directions (1)

13. A constant current flows in a horizontal wire in the plane of the paper from east to west as shown in the given Figure. The direction of magnetic field at a point will be North to South

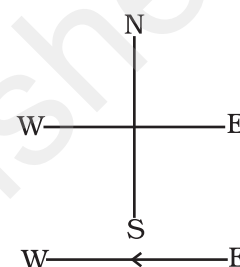

- (a) directly above the wire
- (b) directly below the wire
- (c) at a point located in the plane of the paper, on the north side of the wire
- (d) at a point located in the plane of the paper, on the south side of the wire (1)

14. The major problem in harnessing nuclear energy is how to

- (a) split nuclei
- (b) sustain the reaction
- (c) dispose off spent fuel safely
- (d) convert nuclear energy into electrical energy (1)

15. Which of the statements is incorrect?

- (a) All green plants and blue green algae are producers
- (b) Green plants get their food from organic compounds
- (c) Producers prepare their own food from inorganic compounds
- (d) Plants convert solar energy into chemical energy (1)

Short Answer Questions

16. Write the balanced chemical equations for the following reactions and identify the type of reaction in each case

- (a) Nitrogen gas is treated with hydrogen gas in the presence of a catalyst at 773K to form ammonia gas.
- (b) Limestone is heated strongly to form quicklime and carbondioxide gas is evolved (1+1=2)

- 17.** Salt A commonly used in bakery products on heating converts into another salt B which is used in the manufacture of glass and a gas C is evolved. The gas C when passed through lime water, turns it milky. Identify A, B and C. Write the reaction for heating of salt A. (□ + □ + □ + □ = 2)
- 18.** Properties of the elements are given below. Where would you locate the following elements in the Periodic Table?
- (a) A soft metal stored under kerosene
 - (b) An element with variable (more than one) valency stored under water. (1+1=2)
- 19.** Why is 'nutrition' a necessity for an organism? (2)
- 20.** Why is the flow of signals in a synapse from axonal end of one neuron to dendritic end of another neuron but not the reverse? (2)
- 21.** In human beings, the statistical probability of getting either a male or female child is 50 : 50. Give a suitable explanation.(2)
- 22.** Sudha finds out that the sharp image of the window pane of her science laboratory is formed at a distance of 15 cm from the lens. She now tries to focus the building visible to her outside the window instead of the window pane without disturbing the lens. In which direction will she move the screen to obtain a sharp image of the building? What is the approximate focal length of this lens? (1+1=2)
- 23.** A student sitting at the back of the classroom cannot read clearly the letters written on the blackboard. What advice will a doctor give to her? Draw ray diagram for the correction of this defect. (1 + 1 =2)
- 24.** How will you use two identical prisms so that a ray of white light incident on one prism emerges out of the second prism as white light? Draw the diagram. (2)
- 25.** Three 60 W incandescent bulbs are connected in a parallel.
- (a) Calculate the total power consumed.
 - (b) Now suppose that one of the bulbs is fused. What will be the total power consumed now? (1 + 1 =2)
- 26.** A magnetic compass shows a deflection when placed near a current carrying wire. How will the deflection of the compass get affected if the current in the wire is increased? Support your answer with a reason. (2)

- 27.** What is the difference between the direct and alternating currents?
How many times does AC used in India change direction in one second? (1+1=2)
- 28.** What steps would you suggest to minimise environmental pollution caused by burning of fossil fuels? (2)
- 29.** List the common food chain of a pond ecosystem (2)
- 30.** List two advantages associated with water harvesting at the community level. (2)

Long Answer Questions

- 31.** Explain the following
- (a) The reactivity of a piece of aluminium metal decreases if it is dipped in HNO_3
 - (b) Carbon cannot reduce the oxides of Na or Mg
 - (c) NaCl does not conduct electricity in solid state whereas it does conduct electricity in aqueous solution as well as in molten state
 - (d) Necessity of galvanisation of iron articles
 - (e) Metals like Na, K, Ca and Mg are never found in their free state in nature. (1+1+1+1+1 = 5)

or

Given below are the steps for extraction of copper from its ore.

- (a) Write the equations of the reactions involved in roasting of copper (I) sulphide followed by its reduction.
 - (b) Draw a neat labelled diagram for electrolytic refining (3 + 2 = 5)
- 32.** You are given the balls and sticks models of six carbon atoms and fourteen hydrogen atoms and sufficient number of sticks. In how many ways one can join the models of six carbon atoms and fourteen hydrogen atoms to form different molecules of C_6H_{14} . (5)

or

Draw structural formulae of all the possible isomers of the compound with molecular formula $\text{C}_3\text{H}_6\text{O}$ and also give their electron dot structures. (2 + 3 = 5)

- 33.** Distinguish between pollination and fertilisation. Mention the site and product of fertilisation in a flower. Draw a neat, labelled diagram of a pistil showing pollen tube growth and its entry into the ovule. (1□+1□+2=5)

or

Reproduction is essentially a phenomenon that is not for survival of an individual but for continuation of a species. Justify (5)

- 34.** (a) Draw ray diagrams showing the image formation by a convex lens when an object is placed
- at twice the focal length of the lens
 - at infinity
- (b) The image of a candle flame formed by a lens is obtained on a screen placed on the other side of the lens. If the image is three times the size of the flame and the distance between lens and image is 80 cm, at what distance has the candle been placed from the lens? What is the nature of the image and the lens? (1 + 1 + 3 = 5)

or

Write laws of refraction of light. Explain the same with the help of ray diagram, when a ray of light passes through a rectangular glass slab (2 + 3 = 5)

- 35.** How will you infer with the help of an experiment that the same current flows through every part of the circuit containing three resistances in series connected to a battery? (5)

or

Find out the following in the electric circuit given in the Figure.

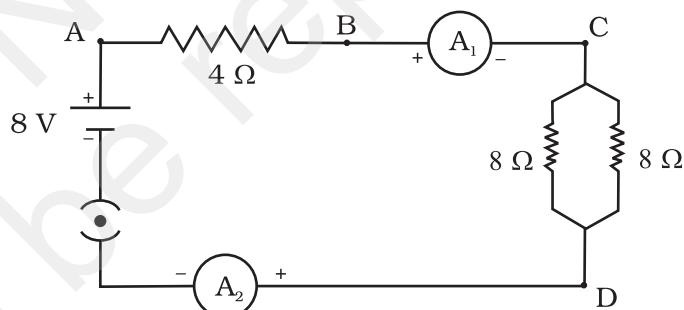

- Effective resistance of two 8 Ω resistors in combination.
 - Current flowing through 4 Ω resistor.
 - Potential difference across 4 Ω resistor.
 - Power dissipated by 4 Ω resistor.
 - Difference in ammeter readings, if any. (1+1+1+1+1= 5)
- 36.** In the context of conservation of natural resources, explain the terms reduce, recycle and reuse. From among the materials that we use in daily life, identify two materials for each category. (5)

or

Suggest a few useful ways of utilising waste water. (5)

ANSWERS

Multiple Choice Questions

1. (b)
2. (d)
3. (b)
4. (d)
5. (d)
6. (b)
7. (a)
8. (a)
9. (c)
10. (b)
11. (d)
12. (d)
13. (b)
14. (c)
15. (b)

Short Answer Questions

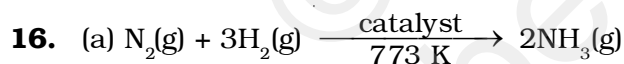

Combination reaction



Decomposition reaction

17. The salt A which is commonly used in bakery product is baking powder (NaHCO_3). On heating it forms B sodium carbonate (Na_2CO_3) and CO_2 gas C is evolved. When $\text{CO}_2(\text{g})$ is passed through lime water, it forms calcium carbonate (CaCO_3), which is sparingly soluble in water making it milky.

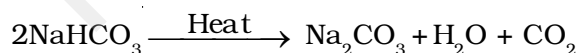

18. (a) Sodium (Na) Group 1 and Period 3
(b) Phosphorus (P) Group 15 and Period 3

- 19.** Food is required for the following purposes.
- It provides energy for the various metabolic processes in the body.
 - It is essential for the growth of new cells and the repair or replacement of worn out cells.
 - It is needed to develop resistance against various diseases.
- 20.** When an electrical signal reaches the axonal end of a neuron, it releases a chemical substance. This chemical diffuses towards the dendrite end of next neuron where it generates an electrical impulse or signal. Hence, the electrical signal is converted into a chemical signal at the axonal end. Since these chemicals are absent at the dendrite end of the neuron, the electrical signal cannot be converted into chemical signal.
- 21.** The sex of an infant is determined by the type of sex chromosome contributed by the male gamete. Since the ratio of male gametes containing X chromosome and those containing Y chromosome is 50 : 50, the statistical possibility of male or a female infant is also 50 : 50.
- 22.** Sudha should move the screen towards the lens so as to obtain a clearer image of the building. The approximate focal length of this lens will be 15 cm.
- 23.** The student is suffering from myopia (Short sightedness). Doctor advises her to use a concave lens of appropriate power to correct this defect.

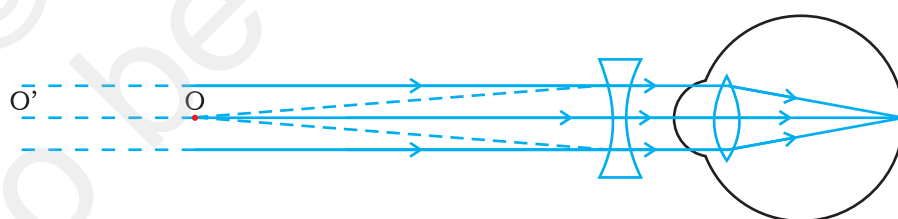

Correction for myopia

- 24. Hint—** By using two identical prisms, one placed inverted with respect to the other.

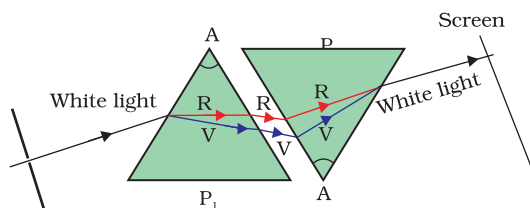

- 25. Hint—** (a) $60\text{ W} \times 3 = 180\text{ W}$. Since wattage in parallel combination becomes three times the wattage of a single bulb.
 (b) 120 W
- 26.** The deflection increases. The strength of magnetic field is directly proportional to the magnitude of current passing through the straight conductor.
- 27.** Direct current always flows in one direction but the alternating current reverses its direction periodically. The frequency of AC in India is 50 Hz and in each cycle it alters direction twice. Therefore AC changes direction $2 \times 50 = 100$ times in one second.
- 28.** (a) Use of alternative source of energy like solar and wind energy
 (b) Use of catalytic converters in vehicles
 (c) Use of refined fuels like CNG
 (d) Proper servicing of vehicles
- 29.** Phytoplanktons and aquatic plants \rightarrow small aquatic animals (insects, larvae etc.) \rightarrow fish \rightarrow bird.
- 30. Hint—** (a) The ground water level increases due to recharging of wells.
 (b) Ground water keeps the layers of soil above it moist and prevents loss of water by evaporation.
 (c) The water can be stored during rainy season and can be used when required.

Long Answer Questions

- 31. Hint—** (a) Due to the formation of a layer of oxide that is, Al_2O_3
 (b) Na or Mg are more reactive metals as compared to carbon
 (c) In solid state the movement of NaCl ions is not possible due to its rigid structure. In molten state, the ions can move freely as the forces of attraction between oppositely charged ions are overcome due to heat. Also, in aqueous solution, the ions are free to move.
 (d) To protect iron from rusting
 (e) They are highly reactive

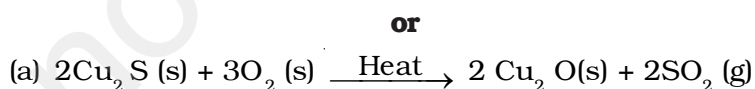

- (b) Diagram for electrolytic refining

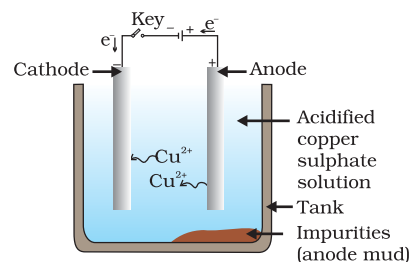

32. C_6H_{14}

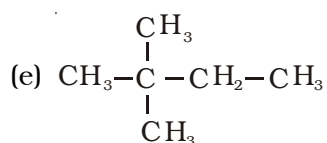
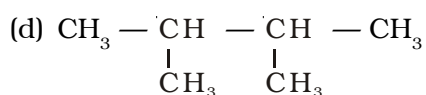
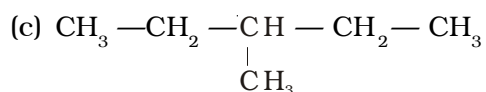
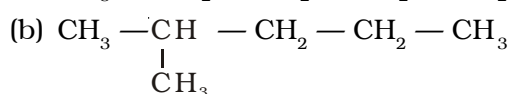
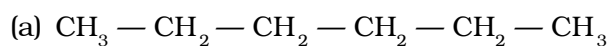

Hint—

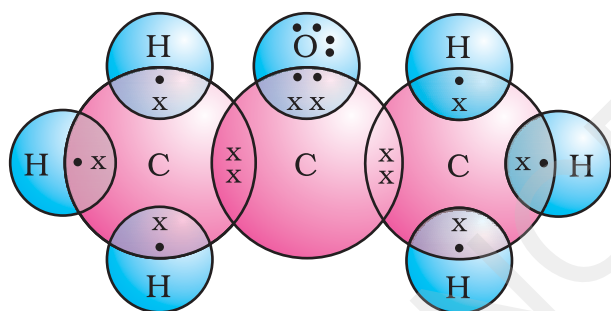

Electron dot structure of propanone

or



Propanone

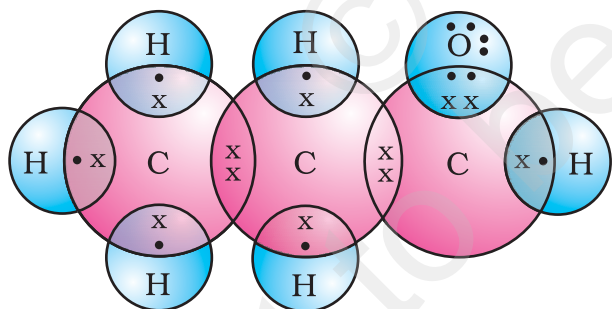

Electron dot structure of propanal

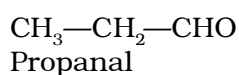

Propanal

33. The process or mechanism of transfer of pollen grains from the anther to the stigma is termed pollination.

The fusion of male and female gametes giving rise to zygote is termed fertilisation.

The site of fertilisation is ovule.

The product of fertilisation is zygote.

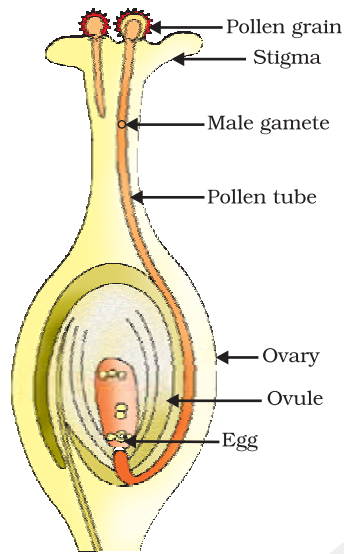

or

Hint—

- (a) For survival an individual needs energy which it obtains from life processes such as nutrition and respiration.
- (b) Reproduction does not provide energy.
- (c) Reproduction ensures transfer of genetic material from one generation to the next which helps in continuation of species.

34. (a)

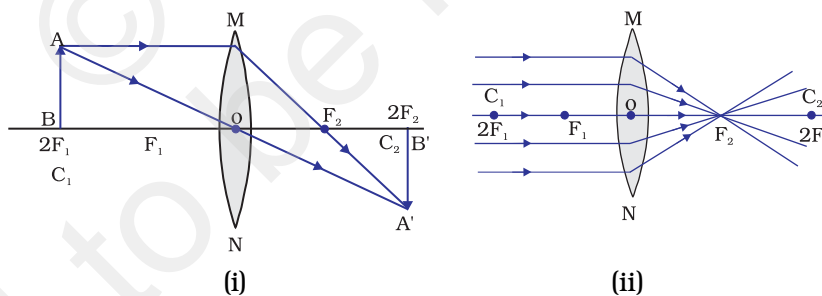

(b) **Hint—** $m = -\frac{v}{u} = -3$, using $\frac{1}{v} - \frac{1}{u} = \frac{1}{f}$ calculate u .

$u = -\frac{80}{3} \text{ cm}$. Image is real and inverted. The lens is convex.

or

Give the laws of refraction

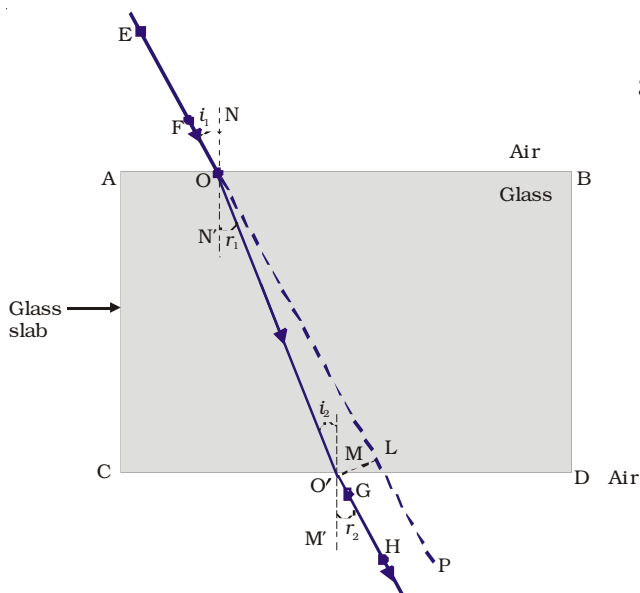

35. Hint— Explain with the help of the diagram

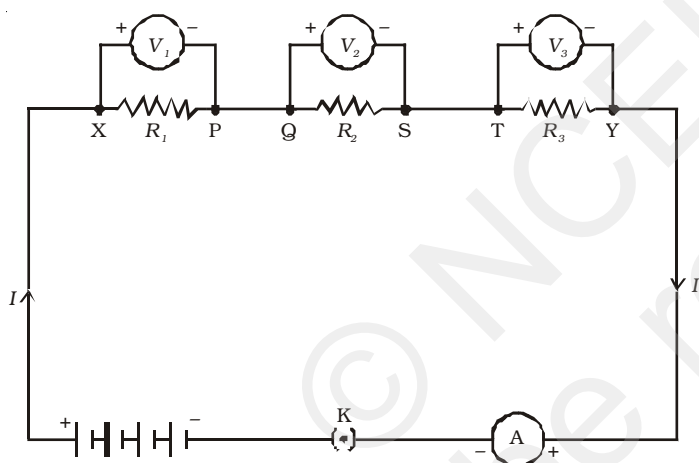

or

Describe the experiment showing that same current flows through each component in a series circuit

- (a) 1 A.
- (b) 4 Ω .
- (c) 4 V.
- (d) 4 W.
- (e) No difference. (Same current flows through each element in a series circuit)

36. Reduce means to use a material/commodity in lesser quantity, e.g. electricity and water.

Recycle means a material that is used once is collected and sent back to a manufacturer so that they can make some other useful material from it.

e.g., plastic cups and buckets, glass tumbler, paper, metal objects.

Reuse means using a thing over and over again instead of throwing it away. It does not involve the process of recycling either in small or large scale: e.g., used envelopes, plastic carry bags, bottles of jam.

or

Hint— The waste water can be used for

- (a) recharging the ground water
- (b) irrigation purpose
- (c) municipal water can be treated and used for washing cars, watering the garden and other domestic uses.
- (c) pollutants in sewage water can become fertilisers for various crops.

© NCERT
not to be republished

SCIENCE
CLASS X (THEORY)
SAMPLE QUESTION PAPER-II

Time : 3 Hours

Maximum Marks : 75

Multiple Choice Questions

1. Which among the following statement(s) is(are) true? Silver chloride on exposure to sunlight for long duration turns grey due to
- (i) the formation of silver by decomposition of silver chloride
 - (ii) sublimation of silver chloride
 - (iii) decomposition of chlorine gas from silver chloride
 - (iv) oxidation of silver chloride
- (a) (i) only
(b) (i) and (iii)
(c) (ii) and (iii)
(d) (iv) only (1)
2. Which of the following oxide(s) of iron would be obtained on prolonged reaction of iron with steam?
- (a) FeO
(b) Fe₂O₃
(c) Fe₃O₄
(d) Fe₂O₃ and Fe₃O₄ (1)
3. $\text{CH}_3\text{CH}_2\text{OH} \xrightarrow{\text{Alkaline KMnO}_4 + \text{Heat}} \text{CH}_3\text{COOH}$
In the above given reaction, alkaline KMnO₄ acts as
- (a) reducing agent
(b) oxidising agent
(c) reducing as well as oxidising agent
(d) dehydrating agent (1)
4. Which of the following gives the correct increasing order of the atomic radii of O, F and N?
- (a) O, F, N
(b) N, O, F
(c) O, N, F
(d) F, O, N (1)

5. Which of the following statement(s) is(are) true about heart?
- (i) Left atrium receives oxygenated blood from different parts of the body while right atrium receives deoxygenated blood from lungs
 - (ii) Left ventricle pumps oxygenated blood to different body parts while right ventricle pumps deoxygenated blood to lungs
 - (iii) Left atrium transfers oxygenated blood to right ventricle which sends it to different parts of the body
 - (iv) Right atrium receives deoxygenated blood from different parts of the body while left ventricle pumps oxygenated blood to different parts of the body
- (a) (i) (b) (ii)
(c) (ii) and (iv) (d) (i) and (iii) (1)
6. The substance that triggers the fall of mature leaves and fruits from plants is
- (a) Auxin
 - (b) Gibberellin
 - (c) Abscisic acid
 - (d) Cytokinin (1)
7. Which among the following statements are true for unisexual flowers?
- (i) They possess both stamen and pistil
 - (ii) They possess either stamen or pistil
 - (iii) They exhibit cross pollination
 - (iv) Unisexual flowers possessing only stamens cannot produce fruits
- (a) (i) and (iv) (b) (ii), (iii) and (iv)
(c) (iii) and (iv) (d) (i), (iii) and (iv) (1)
8. According to the evolutionary theory, formation of a new species is generally due to
- (a) sudden creation by nature
 - (b) accumulation of variations over several generations
 - (c) clones formed during asexual reproduction
 - (d) movement of individuals from one habitat to another (1)
9. Under which of the following conditions the real image formed by a concave mirror is larger than the actual object?
- (a) When source is at a distance equal to radius of curvature of the concave mirror
 - (b) When source is at a distance less than the focal length of the concave mirror
 - (c) When source is placed at a distance between the focus and centre of curvature of the concave mirror
 - (d) When source is placed at a distance greater than the radius of curvature of the concave mirror (1)

10. The path of a ray of light passing through a rectangular glass slab tested by four students are shown in Figure as A, B, C and D. Which one of them is correct?

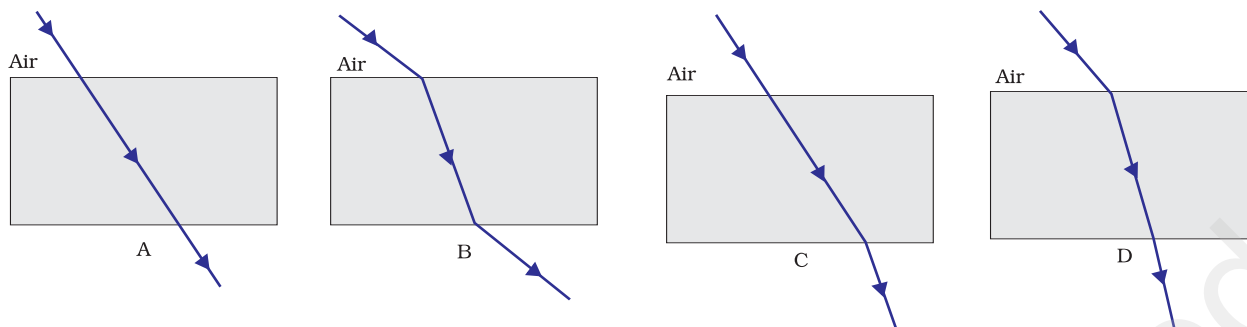

- (a) A
 (b) B
 (c) C
 (d) D
- (1)

11. In the following given circuits, heat produced in the resistor or combination of resistors connected to a 12 V battery will be

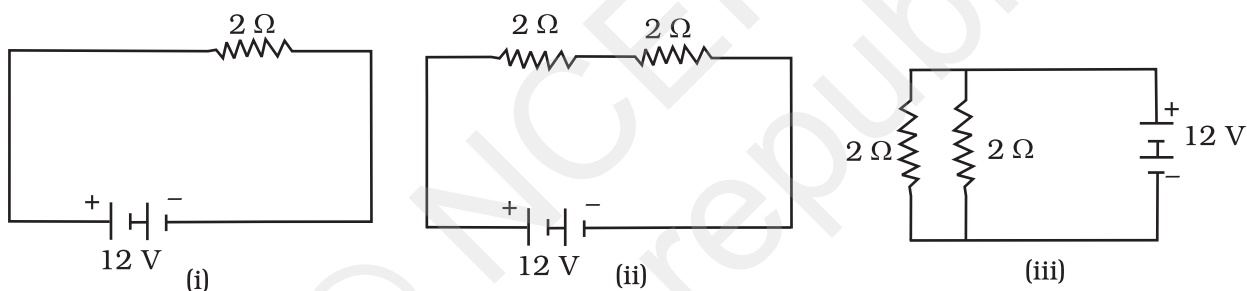

- (a) same in all the cases.
 (b) minimum in case (i).
 (c) maximum in case (ii).
 (d) maximum in case (iii).
- (1)

12. What is the maximum resistance which can be made using five resistors each of $1/5 \Omega$?

- (a) $1/5 \Omega$
 (b) 10Ω
 (c) 5Ω
 (d) 1Ω
- (1)

13. In an electrical circuit three incandescent bulbs A, B and C of rating 40 W, 60 W and 100 W are connected in parallel to an electric source. Which of the following is likely to happen regarding their brightness?

- (a) Brightness of all the bulbs will be the same

- (b) Brightness of bulb A will be the maximum
- (c) Brightness of bulb B will be more than that of A
- (d) Brightness of bulb C will be less than that of B (1)

14. Choose the incorrect statement

- (a) Fleming's right-hand rule is a simple rule to know the direction of induced current
- (b) The right-hand thumb rule is used to find the direction of magnetic fields due to current carrying conductors
- (c) The difference between the direct and alternating currents is that the direct current always flows in one direction, whereas the alternating current reverses its direction periodically
- (d) In India the AC changes direction after every $\frac{1}{50}$ second (1)

15. Among the statements given below select the ones that describe the concept of sustainable development

- (i) Planned growth with minimum damage to the environment
 - (ii) Growth irrespective of the extent of damage caused to the environment
 - (iii) Stopping all developmental work to conserve the environment
 - (iv) Growth that is acceptable to all the stakeholders
- (a) (i) and (iv)
 - (b) (ii) and (iii)
 - (c) (ii) and (iv)
 - (d) (iii) only (1)

Short Answer Questions

16. Identify the oxidising agent (oxidant) in the following reactions

- (a) $\text{Pb}_3\text{O}_4 + 8\text{HCl} \longrightarrow 3\text{PbCl}_2 + \text{Cl}_2 + 4\text{H}_2\text{O}$
- (b) $\text{Mg} + 2\text{H}_2\text{O} \longrightarrow \text{Mg}(\text{OH})_2 + \text{H}_2$
- (c) $\text{CuSO}_4 + \text{Zn} \longrightarrow \text{Cu} + \text{ZnSO}_4$
- (d) $\text{V}_2\text{O}_5 + 5\text{Ca} \longrightarrow 2\text{V} + 5\text{CaO}$ ($\square + \square + \square + \square = 2$)

17. A non-metal A is an important constituent of our food and forms two oxides B and C. Oxide B is toxic whereas C causes global warming

- (a) Identify A, B and C
- (b) To which Group of periodic table A belongs? ($1\square + \square = 2$)

18. Atomic number of a few elements are given below

(i) 10

(ii) 20

(iii) 7

(iv) 14

(a) Identify the elements

(b) Identify the period to which these elements belong

(1 + 1 = 2)

19. What will happen if the mucus is not secreted by the gastric glands? (2)

20. Name the plant hormones responsible for the following

(a) elongation of cells

(b) growth of stem

(c) promotion of cell division

(d) falling of senescent leaves (□ + □ + □ + □ = 2)

21. How are general growth and sexual maturation different from each other? (2)

22. A very small population of a species faces a greater threat of extinction. Provide a suitable genetic explanation. (2)

23. It is established that an electric current through a metallic conductor produces a magnetic field around it. Is there a similar magnetic field produced around a thin beam of moving (i) positively charged alpha particles, (ii) neutrons? Justify your answer by giving suitable arguments. (1 + 1 = 2)

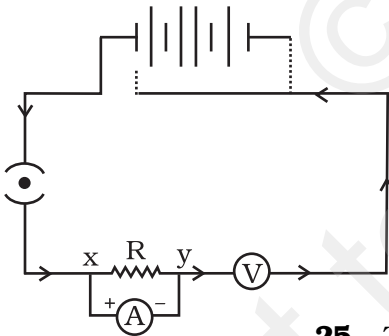

24. A child has drawn the electric circuit to study Ohm's law as shown in the figure. His teacher told that the circuit diagram needs correction.

Study the circuit diagram and redraw it after making all corrections. (2)

25. Three 2Ω resistors, A, B, and C, are connected as shown below. Each of them dissipates and can stand a maximum power of 18 W without melting. Find the maximum current that can flow through the three resistors.

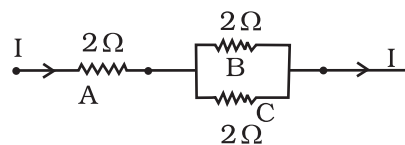

(2)

26. Draw the reflected ray corresponding to the ray incident on a concave mirror as shown in the ray diagram? (2)

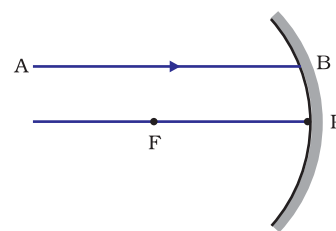

27. Why does a light ray incident on a rectangular glass slab immersed in any medium emerge parallel to itself? Explain using a diagram. (2)

28. A person needs a lens of power -4.5 D for correction of her vision.
 (a) What kind of defect in vision is she suffering from?
 (b) What is the focal length of the corrective lens?
 (c) What is the nature of the corrective lens? (2)

29. In a village in Karnataka, people started cultivating crops all around a lake which was always filled with water. They added fertilisers to their field in order to enhance the yield. Soon they discovered that the waterbody was completely covered with green floating plants and fish in the lake started dying in large numbers.

Analyse the situation and give reasons for excessive growth of plants and death of fishes in the lake. (2)

30. Although coal and petroleum are produced by degradation of bio-mass, yet we need to conserve them. Why? (2)

Long Answer Questions

31. In the following schematic diagram for the preparation of hydrogen gas as shown in Figure, what would happen if following changes are made?

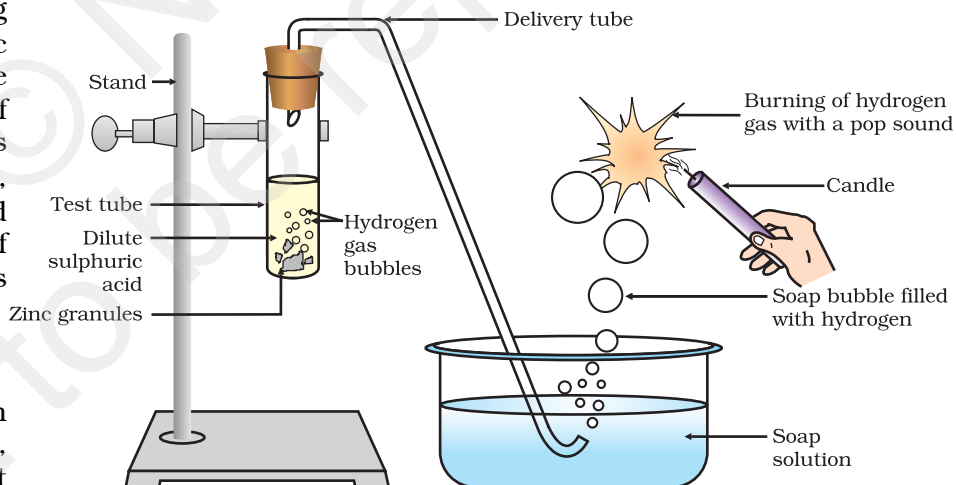

- (a) In place of Zn granules, same amount of zinc dust is taken in the test tube
 (b) Instead of dilute sulphuric acid, dilute hydrochloric acid is taken
 (c) In place of Zn, Cu turnings are taken
 (d) Sodium hydroxide is taken in place of sulphuric acid and tube is heated (1+1+1+1=5)

or

A metal carbonate X on reacting with an acid gives a gas which when passed through a solution Y gives the carbonate back. On the other hand, a gas G that is obtained at anode during electrolysis of brine is passed on dry Y, it gives a compound Z, used for disinfecting drinking water. Identify X, Y, G and Z. Also, write the chemical reactions involved. (5)

32. When ethanoic acid reacts with sodium hydrogencarbonate, a salt X is formed and a gas Y is evolved.

- (a) Identify X and Y. Write chemical equation of reaction involved.
(b) Describe an activity and draw the diagram of the apparatus to prove that the evolved gas is the one which you have named.

(2 + 2 + 1 = 5)

or

Look at Figure and answer the following questions.

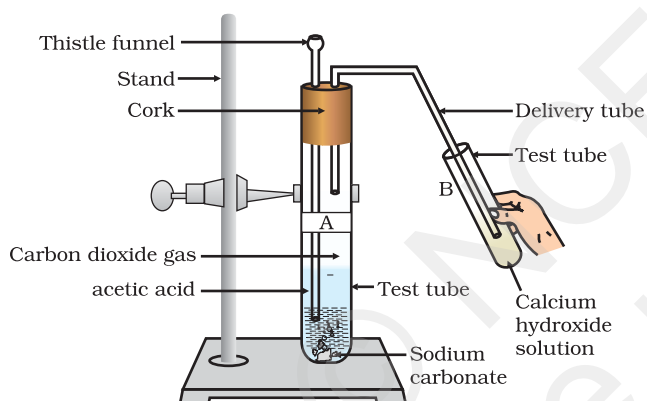

- (a) What change would you observe in tube B containing calcium hydroxide solution
(b) Write the reaction involved in test tubes A and B respectively
(c) If ethanol is given instead of acetic acid, would you expect the same change?
(d) How can a solution of lime water be prepared in the laboratory?

(1+2+1+1 = 5)

33. When do we consider a person to be myopic or hypermetropic? Explain using diagrams how the defects associated with myopic and hypermetropic eye can be corrected? (5)

or

Explain the refraction of light through a triangular glass prism using a labelled ray diagram. Hence define the angle of deviation. (5)

34. How can solar energy be harnessed? What are the limitations in using solar energy? How are these limitations overcome?

(1□+1□+2= 5)

or

What is biomass? Explain the principle and working of a biogas plant using a labelled schematic diagram (2+3 = 5)

- 35.** Explain with the help of a labelled diagram the distribution of a magnetic field due to a current through a circular loop. Why is it that if a current carrying loop has n turns the field produced at any point is n times as large as that produced by a single turn?

(2+3 = 5)

or

Explain the phenomenon of electromagnetic induction? Describe an appropriate experiment to show that a current is set up in a closed loop when an external magnetic field passing through the loop increases or decreases. (2 + 3 = 5)

- 36.** Suggest any five activities in daily life which are eco-friendly. (5)

or

Explain some harmful effects of agricultural practices on the environment. (5)

ANSWERS

Multiple Choice Questions

1. (a)
2. (c)
3. (b)
4. (d)
5. (c)
6. (c)
7. (b)
8. (b)
9. (c)
10. (b)
11. (d)
12. (d)
13. (c)
14. (d)
15. (a)

Short Answer Questions

16. (a) Pb_3O_4
(b) H_2O
(c) CuSO_4
(d) V_2O_5
17. (a) A is carbon, B is carbon monoxide and C is carbon dioxide
(b) Group 14 of periodic table
18. (a) Ne, Ca, N, Si
(b) 2, 3, 2, 3

19. Gastric glands in stomach release hydrochloric acid, enzyme pepsin and mucus. The mucus protects the inner lining of the stomach from the action of hydrochloric acid and enzyme pepsin. If mucus is not released, it will lead to erosion of inner lining of stomach, which may cause acidity and ulcer.
20. (a) Auxin
(b) Gibberellin
(c) Cytokinin
(d) Abscisic acid
21. General growth refers to different types of developmental process in the body like increase in height, weight gain, changes in shape and size of the body but sexual maturation is specific to changes reflected at puberty like cracking of voice, new hair patterns, development of breast in female etc.
22. Fewer individuals in a species impose extensive inbreeding among them. This limits the appearance of variations and puts the species at a disadvantage if there are changes in the environment. Since the individuals fail to cope up with the environmental changes, they may become extinct.
23. **Hint**—(i) Yes, (ii) No. Alpha particles are positively charged particles and therefore a thin beam of moving alpha particles constitutes a current in the direction of motion of the alpha particles. The neutrons on the other hand are electrically neutral and therefore there is no current associated with the thin beam of moving neutrons.

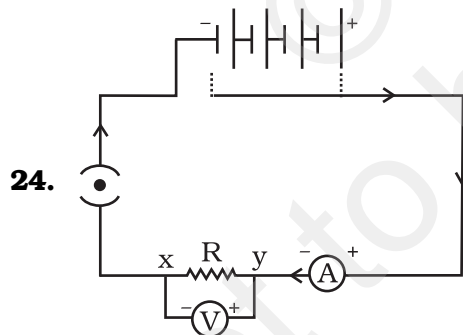

25. Maximum current through resistor A = $\sqrt{\frac{18}{2}}$ A = 3 A.

Thus the maximum current through resistors B and C, each

$$= 3 \times \frac{1}{2} \text{ A} = 1.5 \text{ A.}$$

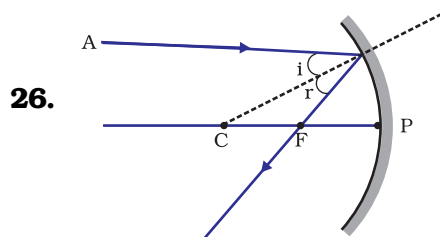

27. **Hint**— Draw the diagram and explain using laws of refraction at both interfaces.

28. (a) Myopia (b) -0.22 m (c) Concave Lens

29. **Hint**— Since people used excessive fertilisers in the fields, they were carried down to the lake by the rains. As many fertilisers contain phosphates and nitrates, the water body became enriched with these chemicals. These chemicals promote excessive growth of aquatic plants and the surface of water was completely covered with plants (eutrophication). Due to insufficient availability of dissolved oxygen and nutrients resulted in the death of fish.

30. Both the energy sources, coal and petroleum, take millions of years for their formation. As these resources are being utilised at a much faster rate than their formation, they will be exhausted in the near future, hence they need to be conserved.

Long Answer Questions

31. **Hint**— (a) Hydrogen gas will evolve with a greater speed

(b) Almost same amount of gas is evolved

(c) Hydrogen gas is not evolved

(d) If sodium hydroxide is taken, hydrogen gas will be evolved

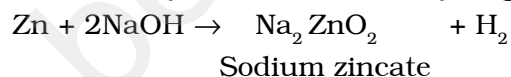

or

The gas G evolved at anode during electrolysis of brine is chlorine

When chlorine gas is passed through dry $\text{Ca}(\text{OH})_2$ (Y), it produces bleaching powder Z used for disinfecting drinking water.

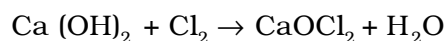

Slaked Bleaching

lime powder

Since Y and Z are calcium salts, therefore X is also a calcium salt and is calcium carbonate.

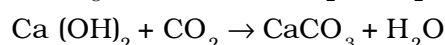
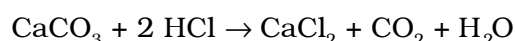

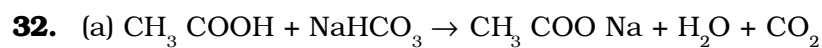

X is sodium ethanoate

Gas evolved is carbon dioxide (Y)

(b) The gas evolved during the reaction is passed through a delivery tube into the test tube containing lime water. The lime water solution turns milky due to the formation of calcium carbonate, a characteristic property of CO_2 gas.

or

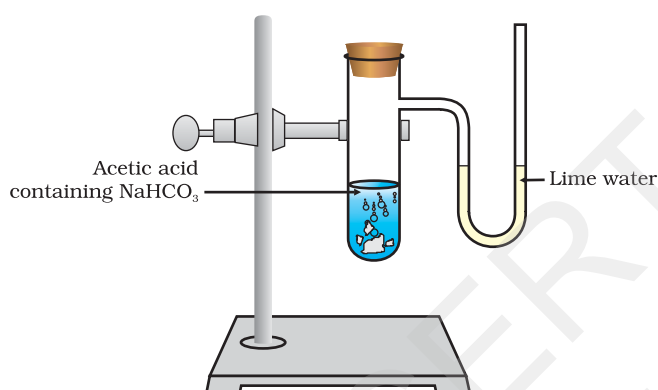

(a) It will turn milky



With excess CO_2 , milkyness disappears.



(c) As $\text{C}_2\text{H}_5\text{OH}$ and Na_2CO_3 do not react, a similar change is not expected



(d) The lime water is prepared by dissolving calcium oxide in water and decanting the supernatant liquid. The reaction is referred to as slaking of lime

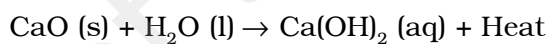

33.

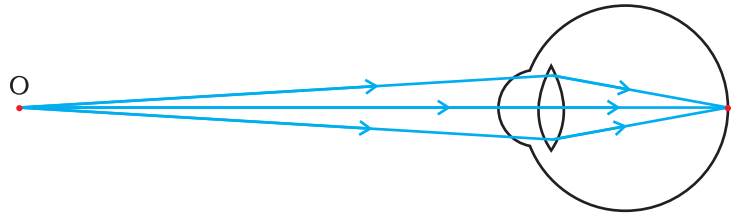

(a) Far point

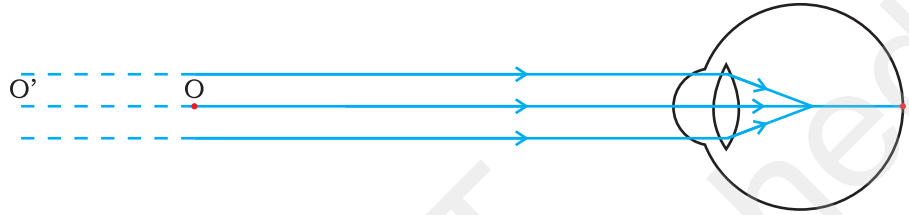

(b) Myopic Eye

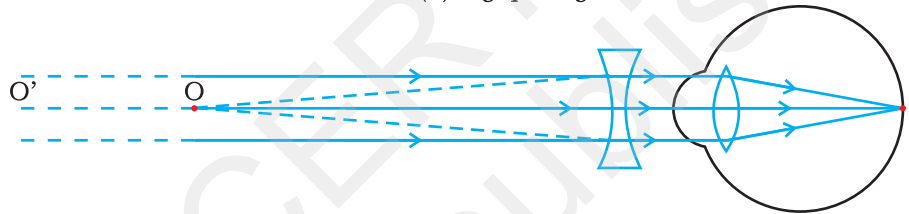

(c) Correction for myopia

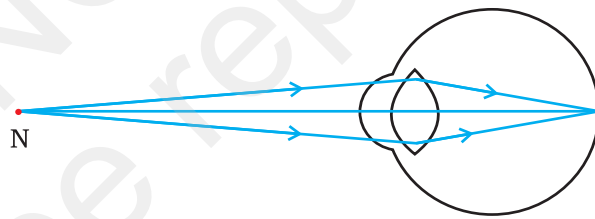

(a) Near point

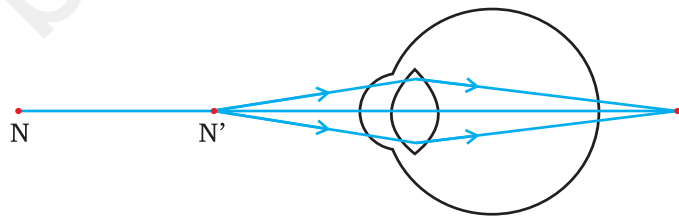

(b) Hypermetropic eye

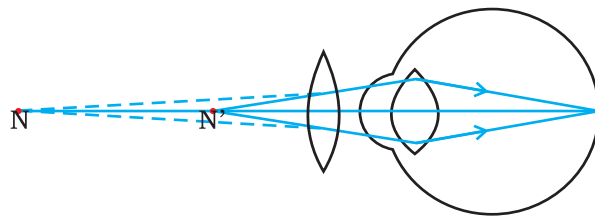

(c) Correction for hypermetropia

Hint— When a person is not able to see distant objects clearly but can see nearby objects clearly then he/she is considered to be myopic. If it is otherwise, he/she is hypermetropic. Give explanation based on figures.

or

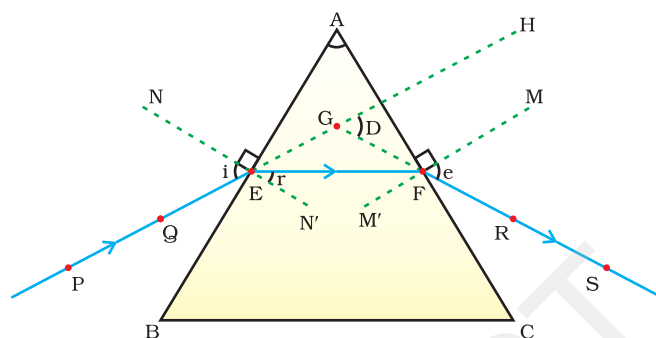

Hint— Give explanation based on figure. Angle of deviation is the angle D, between the incident ray and the emergent ray when a light ray passes through a glass prism.

- 34. Hint—** Answer must include working of a solar device using reflectors/solar cell; limitations; available during day time/sunny days. Requires huge costly installations. To overcome limitation: use of solar cell.

or

Hint— Biomass- Plant and animal wastes

Give description of biogas plant with the help of label diagram.

35.

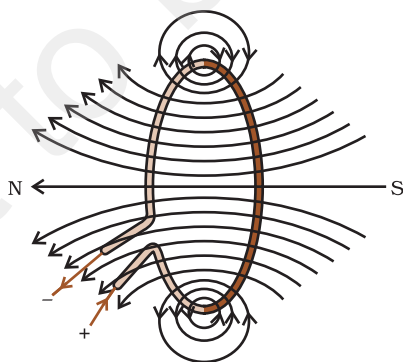

Hint— The magnetic field at a point is the resultant of the field produced by each turn.

or

Hint— The process by which changing magnetic field in a conductor induces a current in another conductor is called electromagnetic induction.

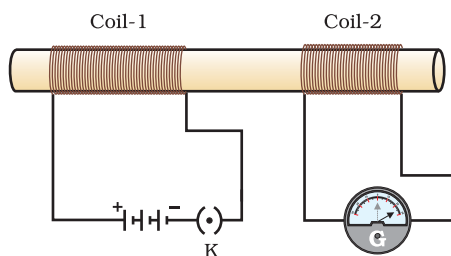

Explain the working of the setup with the help of the diagram.

- 36. Hint—** (i) Separation of biodegradable and non-biodegradable substances.
- (ii) Gardening
- (iii) Use of gunny bags/paper bags in place of polythene/plastic bags
- (iv) Use of compost and vermicompost in place of fertilisers
- (v) Harvesting rain water

or

Hint—

- (a) Excessive use of fertilisers changes the chemistry of soil and kills useful microbes.
- (b) Excessive use of non-biodegradable chemical pesticides leads to biological magnification.
- (c) Extensive cropping causes loss of soil fertility.
- (d) Excessive use of ground water for agriculture lowers the water table.
- (e) Damage to natural ecosystem/habitat.

CHAPTER 1

ANSWERS

Multiple Choice Questions

1. (d) 2. (c)
3. (c) **Hint**— The substance which oxidises the other substances in a chemical reaction is known as an oxidising agent. Likewise, the substance which reduces the other substance in a chemical reaction is known as reducing agent.
4. (a) 5. (c) 6. (a) 7. (b)
8. (a) 9. (b) 10. (d) 11. (b)
12. (d)
13. (b) **Hint**— Lead sulphate being insoluble will not dissociate into Pb^{2+} ions.
14. (d) 15. (a) 16. (d) 17. (d)
18. (d)

Short Answer Questions

19. (a) $\text{N}_2(\text{g}) + 3\text{H}_2(\text{g}) \xrightarrow[773 \text{ K}]{\text{Catalyst}} 2\text{NH}_3(\text{g})$
Combination reaction
- (b) $\text{NaOH}(\text{aq}) + \text{CH}_3\text{COOH}(\text{aq}) \longrightarrow \text{CH}_3\text{COONa}(\text{aq}) + \text{H}_2\text{O}(\text{l})$
Double displacement reaction/Neutralisation reaction
- (c) $\text{C}_2\text{H}_5\text{OH}(\text{l}) + \text{CH}_3\text{COOH}(\text{l}) \xrightarrow{\text{H}^+} \text{CH}_3\text{COOC}_2\text{H}_5(\text{l}) + \text{H}_2\text{O}(\text{l})$
Double displacement reaction/Esterification reaction
- (d) $\text{C}_2\text{H}_4(\text{g}) + 3\text{O}_2(\text{g}) \longrightarrow 2\text{CO}_2(\text{g}) + 2\text{H}_2\text{O}(\text{g}) + \text{Heat} + \text{Light}$
Redox reaction/Combustion reaction

20. (a) $\text{Fe}_2\text{O}_3(\text{s}) + 2\text{Al}(\text{s}) \longrightarrow \text{Al}_2\text{O}_3(\text{s}) + 2\text{Fe}(\text{l}) + \text{Heat}$
Displacement reaction/Redox reaction

(b) $3\text{Mg}(\text{s}) + \text{N}_2(\text{g}) \longrightarrow \text{Mg}_3\text{N}_2(\text{s})$
Combination reaction

(c) $2\text{KI}(\text{aq}) + \text{Cl}_2(\text{g}) \longrightarrow 2\text{KCl}(\text{aq}) + \text{I}_2(\text{s})$
Displacement reaction

(d) $\text{C}_2\text{H}_5\text{OH}(\text{l}) + 3\text{O}_2(\text{g}) \longrightarrow 2\text{CO}_2(\text{g}) + 3\text{H}_2\text{O}(\text{l}) + \text{Heat}$
Redox reaction/Combustion reaction

21. (a) $\mathbf{x} \longrightarrow (\text{s})$
 $\mathbf{y} \longrightarrow (\text{aq})$
(b) $\mathbf{x} \longrightarrow 2 \text{Ag}$
(c) $\mathbf{x} \longrightarrow (\text{aq})$
 $\mathbf{y} \longrightarrow (\text{g})$
(d) $\mathbf{x} \longrightarrow \text{Heat}$

22. (b) and (c) are exothermic as heat is released in these changes.
(a) and (d) are endothermic as heat is absorbed in these changes

23. (a) Ammonia (NH_3)
(b) Water (H_2O) as F_2 is getting reduced to HF
(c) Carbon monoxide (CO)
(d) Hydrogen

Hint—Reducing agents are those substances which have the ability of adding hydrogen or removing oxygen from the other substances.

24. (a) Pb_3O_4
(b) O_2
(c) CuSO_4
(d) V_2O_5
(e) H_2O
(f) CuO

25. (a) $\text{Na}_2\text{CO}_3 + \text{HCl} \longrightarrow \text{NaCl} + \text{NaHCO}_3$
(b) $\text{NaHCO}_3 + \text{HCl} \longrightarrow \text{NaCl} + \text{H}_2\text{O} + \text{CO}_2$
(c) $2\text{CuSO}_4 + 4\text{KI} \longrightarrow \text{Cu}_2\text{I}_2 + 2\text{K}_2\text{SO}_4 + \text{I}_2$

26. $\text{KCl}(\text{aq}) + \text{AgNO}_3(\text{aq}) \longrightarrow \text{AgCl}(\text{s}) + \text{KNO}_3(\text{aq})$

It is a double displacement and precipitation reaction.

27. $2\text{FeSO}_4(\text{s}) \xrightarrow{\text{Heat}} \text{Fe}_2\text{O}_3(\text{s}) + \text{SO}_2(\text{g}) + \text{SO}_3(\text{g})$

It is a thermal decomposition reaction

- 28.** Fire flies have a protein which in the presence of an enzyme undergoes aerial oxidation. This is a chemical reaction which involves emission of visible light. Therefore, fire flies glow at night.
- 29.** Grapes when attached to the plants are living and therefore their own immune system prevents fermentation. The microbes can grow in the plucked grapes and under anaerobic conditions these can be fermented. This is a chemical change.
- 30.** (a), (c) and (e) — are physical changes.
(b) and (d) are chemical changes
- 31. Hint—** (a) Silver metal does not react with dilute HCl
(b) The temperature of the reaction mixture rises when aluminium is added because it is an exothermic reaction.
(c) Reaction of sodium metal is found to be highly explosive because it is an exothermic reaction
(d) When lead is treated with hydrochloric acid, bubbles of hydrogen gas are evolved

$$\text{Pb} + 2\text{HCl} \rightarrow \text{PbCl}_2 + \text{H}_2$$
- 32.** Calcium oxide

$$\text{CaO(s)} + \text{H}_2\text{O(l)} \longrightarrow \text{Ca(OH)}_2\text{(aq)}$$
- 33.** (a) $\text{Pb(CH}_3\text{COO)}_2 + 2\text{HCl} \longrightarrow \text{PbCl}_2 + \text{CH}_3\text{COOH}$; Double displacement reaction
(b) $2\text{Na} + 2\text{C}_2\text{H}_5\text{OH} \longrightarrow 2\text{C}_2\text{H}_5\text{ONa} + \text{H}_2$; Displacement reaction
(c) $\text{Fe}_2\text{O}_3 + 3\text{CO} \longrightarrow 2\text{Fe} + 3\text{CO}_2$; Redox reaction
(d) $2\text{H}_2\text{S} + \text{O}_2 \longrightarrow 2\text{S} + 2\text{H}_2\text{O}$; Redox reaction
- 34.** Silver chloride on exposure to sunlight may decompose as per the following reaction.

$$2\text{AgCl} \longrightarrow 2\text{Ag} + \text{Cl}_2$$

 Therefore, it is stored in dark coloured bottles.
- 35.** (a) Balanced; Combination reaction
(b) $2\text{HgO (s)} \xrightarrow{\text{Heat}} 2\text{Hg (l)} + \text{O}_2 \text{ (g)}$; Decomposition reaction
(c) $2\text{Na (s)} + \text{S (s)} \xrightarrow{\text{Fuse}} \text{Na}_2\text{S (s)}$; Combination reaction
(d) $\text{TiCl}_4 \text{ (l)} + 2\text{Mg (s)} \longrightarrow \text{Ti (s)} + 2\text{MgCl}_2 \text{ (s)}$; Displacement reaction
(e) Balanced; Combination reaction
(f) $2\text{H}_2\text{O}_2 \text{ (l)} \xrightarrow{\text{UV}} 2\text{H}_2\text{O (l)} + \text{O}_2 \text{ (g)}$; Decomposition reaction

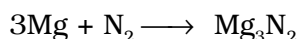

(a) X is MgO; Y is Mg_3N_2

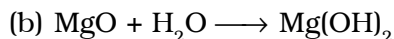

37. Zinc is above hydrogen whereas copper is below hydrogen in the activity series of metals. That is why zinc displaces hydrogen from dilute hydrochloric acid, while copper does not.

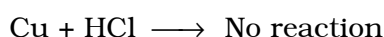
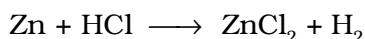

38. (a) Metals such as silver when attacked by substances around it such as moisture, acids, gases etc, are said to corrode and this phenomenon is called corrosion.

(b) The black substance is formed because silver (Ag) reacts with H_2S present in air. It forms thin black coating of silver sulphide (Ag_2S).

Long Answer Questions

39. (a) Balanced chemical equation



(b) The brown gas X evolved is nitrogen dioxide (NO_2)

(c) This is a decomposition reaction

(d) Nitrogen dioxide dissolves in water to form acidic solution because it is an oxide of non-metal. Therefore, pH of this solution is less than 7

40. The characteristic test for

(a) Carbon dioxide (CO_2) gas turns lime water milky when passed through it due to the formation of insoluble calcium carbonate.

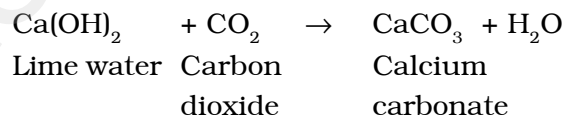

(b) Sulphur dioxide (SO_2) gas when passed through acidic potassium permanganate solution (purple in colour) turns it colourless because SO_2 is a strong reducing agent

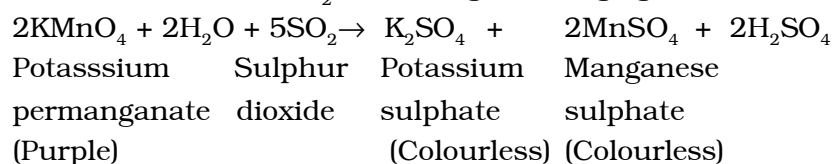

or

Sulphur dioxide gas when passed through acidic dichromate solution (orange in colour) turns it to green because sulphur dioxide is a strong reducing agent.

- (c) The evolution of oxygen (O₂) gas during a reaction can be confirmed by bringing a burning candle near the mouth of the test tube containing the reaction mixture. The intensity of the flame increases because oxygen supports burning.
- (d) Hydrogen (H₂) gas burns with a pop sound when a burning candle is brought near it.

- 41.** (a) Zinc being more reactive than copper displaces copper from its solution and a solution of zinc sulphate is obtained

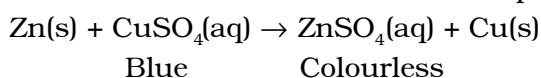

This is an example of displacement reaction

- (b) Aluminium being more reactive displaces hydrogen from dilute hydrochloric acid solution and hydrogen gas is evolved.

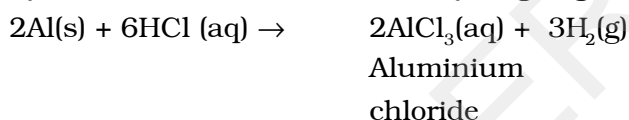

- (c) Silver metal being less reactive than copper cannot displace copper from its salt solution. Therefore, no reaction occurs

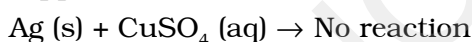

- 42.** The reaction of Zn granules with

- (a) Dilute H₂SO₄



- (b) Dilute HCl

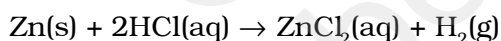

- (c) Dilute HNO₃

Reaction with dilute HNO₃ is different as compared to other acids because nitric acid is an oxidising agent and it oxidises H₂ gas evolved to H₂O.

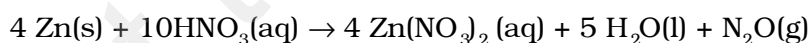

- (d) NaCl solution

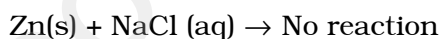

- (e) NaOH solution

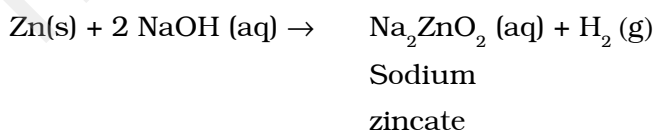

43. (a) Balanced chemical equation

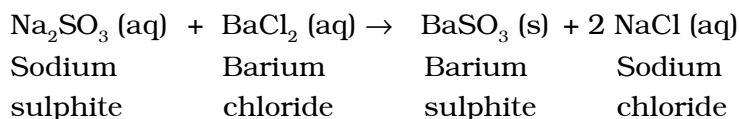

(b) This reaction is also known as double displacement reaction

(c) BaSO_3 is a salt of a weak acid (H_2SO_3), therefore dilute acid such as HCl decomposes barium sulphite to produce sulphur dioxide gas which has the smell of burning sulphur.



White ppt.

BaCl_2 is soluble in water, hence white precipitate disappears

44. (A) When solutions are kept in copper container

(a) Dilute HCl

Copper does not react with dilute HCl. Therefore, it can be kept.

(b) Dilute HNO_3

Nitric acid acts as a strong oxidising agent and reacts with copper vessel, therefore cannot be kept.

(c) ZnCl_2

Zinc is more reactive than copper (Cu) therefore, no displacement reaction occurs and hence can be kept.

(d) H_2O

Copper does not react with water. Therefore, can be kept.

(B) When solutions are kept in aluminium containers

(a) Dilute HCl

Aluminium reacts with dilute HCl to form its salt and hydrogen is evolved. Therefore, cannot be kept.

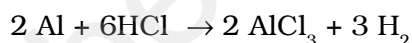

(b) Dilute HNO_3

Aluminium gets oxidised by dilute HNO_3 to form a layer of Al_2O_3 and can be kept.

(c) ZnCl_2

Aluminium being more reactive than zinc can displace zinc ion from the solution. Therefore, the solution cannot be kept.

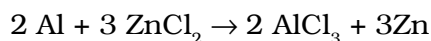

(d) H_2O

Aluminium does not react with cold or hot water. Therefore, water can be kept.

Aluminium is attacked by steam to form aluminium oxide and hydrogen

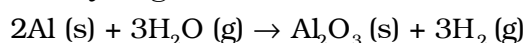

CHAPTER 2

ANSWERS

Multiple Choice Questions

1. (d) 2. (d) 3. (c) 4. (b)
5. (d) 6. (a) 7. (d) 8. (a)
9. (b) 10. (b) 11. (c) 12. (b)
13. (c) 14. (d) 15. (a) 16. (b)
17. (c) 18. (d) 19. (a) 20. (c)
21. (d) 22. (b) 23. (d) 24. (b)
25. (c) 26. (c)
27. (c) **Hint—** Though HCl gas is a covalent compound, in the aqueous solution it ionizes to form H^+ (aq) and Cl^- (aq) ions.
28. (c) 29. (a) 30. (d)

Short Answer Questions

31. (a)— (iv) (b)— (iii) (c)— (ii) (d)— (i)
32. (a)— (ii) (b)— (iii) (c)— (iv) (d)— (i)

33.	Substance	Action on Litmus paper
	Dry HCl gas	No change
	Moistened NH_3 gas	Turns red to blue
	Lemon juice	Turns blue to red
	Carbonated soft drink	Turns blue to red
	Curd	Turns blue to red
	Soap solution	Turns red to blue

34. The acid present in ant sting is methanoic acid (formic acid). The chemical formula is HCOOH . To get relief one should apply any available basic salt e.g., baking soda (NaHCO_3) on it.

- 35.** Egg shells contain calcium carbonate. When nitric acid is added to it, carbon dioxide gas is evolved. The reaction can be given as



- 36. Hint—** Using chemical indicator like phenolphthalein or natural indicators like turmeric, china rose etc.

- 37.** The chemical formula of baking powder is sodium hydrogencarbonate (NaHCO_3). Whereas, that of washing soda is sodium carbonate ($\text{Na}_2\text{CO}_3 \cdot 10\text{H}_2\text{O}$)

Sodium hydrogencarbonate on heating gives CO_2 gas which will turn lime water milky whereas no such gas is obtained from sodium carbonate.

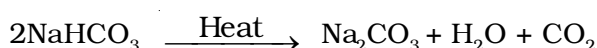

- 38.** Baking powder (NaHCO_3), salt A is commonly used in bakery products. On heating it forms sodium carbonate (Na_2CO_3), B and CO_2 gas, C is evolved. When CO_2 gas is passed through lime water it forms calcium carbonate (CaCO_3), which is slightly soluble in water making it milky.

A — NaHCO_3

B — Na_2CO_3

C — CO_2 gas

- 39.** In the manufacture of sodium hydroxide, hydrogen gas and chlorine gas (X) are formed as by-products. When chlorine gas (X) reacts with lime water, it forms calcium oxychloride (bleaching powder) Y. The reactions are

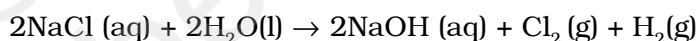

X → Cl_2 (Chlorine gas)

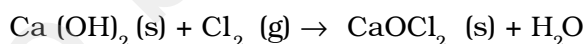

Y — Calcium oxychloride (bleaching powder)

40.

	Name of the salt	Formula	Salt obtained from	
			Base	Acid
(i)	Ammonium chloride	NH_4Cl	NH_4OH	<u>HCl</u>
(ii)	Copper sulphate	<u>CuSO_4</u>	<u>$\text{Cu}(\text{OH})_2$</u>	H_2SO_4
(iii)	Sodium chloride	NaCl	NaOH	<u>HCl</u>
(iv)	Magnesium nitrate	$\text{Mg}(\text{NO}_3)_2$	<u>$\text{Mg}(\text{OH})_2$</u>	HNO_3
(v)	Potassium sulphate	K_2SO_4	<u>KOH</u>	<u>H_2SO_4</u>
(vi)	Calcium nitrate	$\text{Ca}(\text{NO}_3)_2$	$\text{Ca}(\text{OH})_2$	<u>HNO₃</u>

- 41.** In aqueous solutions strong acids ionise completely and provide hydronium ions. On the other hand weak acids are partially ionised and an aqueous solution of same molar concentration provides a much smaller concentration of H_3O^+ ions.

Strong acids — Hydrochloric acid, sulphuric acid, nitric acid

Weak acid — Citric acid, acetic acid, formic acid

- 42.** When zinc reacts with dilute solution of strong acid, it forms salt and hydrogen gas is evolved.

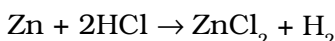

When a burning splinter is brought near the mouth of the test tube, the gas burns with a pop sound.

Long Answer Questions

- 43. Hint—** (a) Hydrogen gas will evolve with greater speed

(b) Almost same amount of gas is evolved

(c) Hydrogen gas is not evolved

(d) If sodium hydroxide is taken, hydrogen gas will be evolved

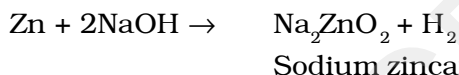

- 44.** (a) Baking soda is sodium hydrogencarbonate. On heating, it is converted into sodium carbonate which is bitter to taste



(b) Baking soda can be converted into baking powder by the addition of appropriate amount of tartaric acid to it.

(c) The role of tartaric acid is to neutralise sodium carbonate and cake will not taste bitter.

- 45.** The gas evolved at anode during electrolysis of brine is chlorine (G)

When chlorine gas is passed through dry $\text{Ca}(\text{OH})_2$ (Y) produces bleaching powder (Z) used for disinfecting drinking water.



Slaked Bleaching

lime powder

Since Y and Z are calcium salts, therefore X is also a calcium salt and is calcium carbonate.

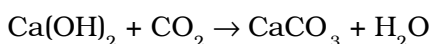
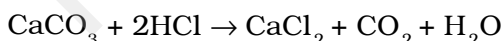

- 46.** Sodium hydroxide (NaOH) is a commonly used base and is hygroscopic, that is, it absorbs moisture from the atmosphere and becomes sticky.

The acidic oxides react with base to give salt and water. The reaction between NaOH and CO₂ can be given as

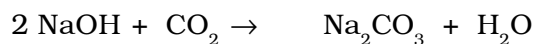

- 47.** The substance which is used for making different shapes is Plaster of Paris. Its chemical name is calcium sulphate hemihydrate (CaSO₄ · $\frac{1}{2}$ H₂O). The two formula unit of CaSO₄ share one molecule of water. As a result, it is soft.

When it is left open for some time, it absorbs moisture from the atmosphere and forms gypsum, which is a hard solid mass.

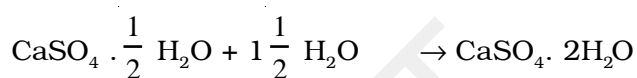

Plaster of Paris

(Soft)

(Sulphate salt)

Gypsum

(Hard mass)

- 48.** X— NaOH (Sodium hydroxide)
A— Na₂ZnO₂ (Sodium zincate)
B— NaCl (Sodium chloride)
C— CH₃COONa (Sodium acetate)



CHAPTER 3

ANSWERS

Multiple Choice Questions

1. (c) 2. (a) 3. (d) 4. (d)
5. (c) **Hint**— $3 \text{ Fe (s)} + 4 \text{ H}_2\text{O (g)} \rightarrow \text{Fe}_3\text{O}_4 \text{ (s)} + 4 \text{ H}_2 \text{ (g)}$
6. (d) 7. (c) 8. (c) 9. (b)
10. (b) 11. (c) 12. (a) 13. (c)
14. (c) 15. (a) 16. (b) 17. (d)
18. (d) 19. (d)
20. (b) **Hint**— Reactivity series $\text{Mg} > \text{Zn} > \text{Cu} > \text{Ag}$
21. (b) 22. (c) 23. (b) 24. (a)
25. (b) 26. (d) 27. (b) 28. (d)
29. (b) 30. (d) 31. (c) 32. (b)
33. (c) 34. (b) 35. (d) 36. (c)

Short Answer Questions

37. The produced gas can be identified by bringing a burning match stick near the reaction vessel, a pop sound is produced
- $$\text{M} + 2\text{NaOH} \rightarrow \text{Na}_2\text{MO}_2 + \text{H}_2$$
- $$\text{M} + 2\text{HCl} \rightarrow \text{MCl}_2 + \text{H}_2$$
- The element is a metal
38. (a) Anode : Impure silver
Cathode : Pure silver
- (b) Electrolyte: Silver salt, such as AgNO_3
- (c) We get pure silver at cathode
39. It is easier to obtain metal from its oxide, as compared from its sulphides and carbonates.

- 40.** It is because HNO_3 is a strong oxidising agent. It oxidises the H_2 produced to H_2O .
- 41.** (a) X — Fe_2O_3 (b) Thermite reaction
(c) $\text{Fe}_2\text{O}_3(\text{s}) + 2\text{Al}(\text{s}) \rightarrow 2\text{Fe}(\text{l}) + \text{Al}_2\text{O}_3(\text{s}) + \text{Heat}$
- 42.** X — Na, Y — NaOH, Z — H_2
 $2\text{Na} + 2\text{H}_2\text{O} \rightarrow 2\text{NaOH} + \text{H}_2 + \text{Heat energy}$
- 43.** X — Carbon; Y — Diamond and Z — Graphite
- 44.** (a) No, because oxygen is added to aluminium therefore, it is getting oxidised
(b) No, since manganese has lost oxygen therefore, it is getting reduced.
- 45.** Solder is an alloy of lead and tin. Low melting point of solder makes it suitable for welding electrical wires.
- 46.** A — Al; B — Al_2O_3
 $\text{Al}_2\text{O}_3 + 6\text{HCl} \rightarrow 2\text{AlCl}_3 + 3\text{H}_2\text{O}$
 $\text{Al}_2\text{O}_3 + 2\text{NaOH} \rightarrow 2\text{NaAlO}_2 + \text{H}_2\text{O}$
- 47.** Metals low in activity series can be obtained by reducing their sulphides or oxides by heating. Mercury is the only metal that exists as liquid at room temperature. It can be obtained by heating cinnabar (HgS), the sulphide ore of mercury.
The reactions are as follows:
 $2\text{HgS} + 3\text{O}_2 \xrightarrow{\text{Heat}} 2\text{HgO} + 2\text{SO}_2$
 $2\text{HgO} \xrightarrow{\text{Heat}} 2\text{Hg} + \text{O}_2$
- 48.** (a) Mg_3N_2 (b) Li_2O (c) AlCl_3 (d) K_2O
- 49.** (a) It undergoes calcination. The chemical reaction can be given as
 $\text{ZnCO}_3 \xrightarrow{\text{Heat}} \text{ZnO} + \text{CO}_2$
(b) It undergoes auto reduction forming copper and sulphur dioxide
 $2\text{Cu}_2\text{O} + \text{Cu}_2\text{S} \xrightarrow{\text{Heat}} 6\text{Cu} + \text{SO}_2$
- 50.** (a) A is carbon, B is carbon monoxide and C is carbon dioxide
(b) A belongs to Group – 14 of the Periodic Table
- 51.** (a) Good conductor : Ag and Cu
(b) Poor conductor : Pb and Hg

52. Metal – Mercury (Hg); Non-metal – Bromine (Br)

Two metals with melting points less than 310K are Cesium (Cs) and Gallium (Ga)

53. A – Ca; B – Ca(OH)₂; C – CaO

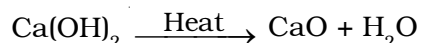

54. A – Na; B – NaOH; C – NaAlO₂

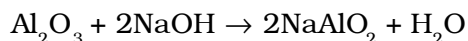
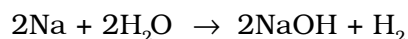

55. (a) $2\text{ZnS}(\text{s}) + 3\text{O}_2 \xrightarrow{\text{Heat}} 2\text{ZnO}(\text{s}) + 2\text{SO}_2(\text{g})$



56. M = Cu; Black product – CuO

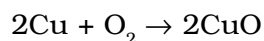

57. Since an oxide of element is acidic in nature, therefore, A will be a non-metal.

58. Fe is more reactive as compared to Cu. Therefore, Fe displaces Cu from CuSO₄ and forms FeSO₄.

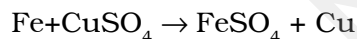

Long Answer Questions

59. (a) A – N₂; B – NH₃; C – NO; D – HNO₃

(b) Element **A** belongs to Group -15 of the Periodic Table

60. Sulphide ore of low reactivity metal

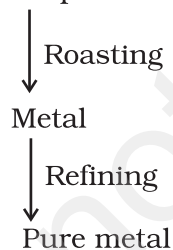

Sulphide ore of medium reactivity metal

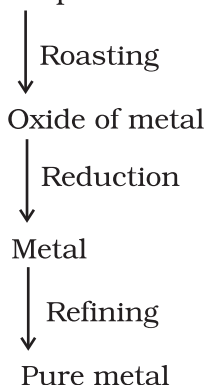

- 61. Hint—** (a) Due to the formation of a layer of oxide i.e., Al_2O_3
 (b) Na or Mg are more reactive metals as compared to carbon
 (c) In solid NaCl, the movement of ions is not possible due to its rigid structure but in aqueous solution or molten state, the ions can move freely.
 (d) To protect from corrosion
 (e) They are highly reactive

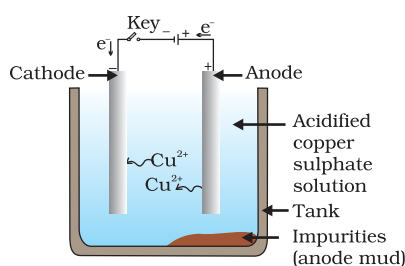

62. (i) (a) Roasting of sulphide ore



This reaction is known as auto-reduction

(c) Reaction for electrolytic refining

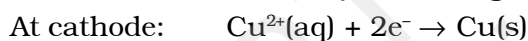

(ii) Diagram for electrolytic refining of copper

63. X is alkali metal, Na or K

Y is alkaline earth metal, Mg or Ca

Z is Fe

Increasing reactivity series: $\text{Na} > \text{Mg} > \text{Fe}$

64. A = Na; B = Cl_2 ; C = NaCl; D = NaOH

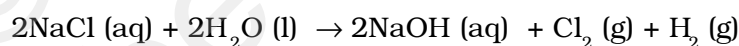
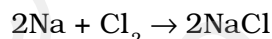

65. Since ore A gives CO_2 and ore B gives SO_2 . Therefore, ores are MCO_3 and MS.

A can be obtained

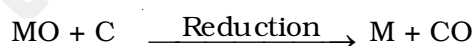

B can be obtained

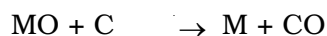

CHAPTER 4

ANSWERS

Multiple Choice Questions

1. (b) 2. (d) 3. (a) 4. (c)
5. (c) 6. (b) 7. (a) 8. (b)
9. (a) 10. (d) 11. (a) 12. (d)
13. (b) 14. (a) 15. (c) 16. (c)
17. (c) 18. (d) 19. (c) 20. (a)
21. (b) 22. (c) 23. (d) 24. (c)
25. (d) 26. (a) 27. (d) 28. (d)
29. (a)

Short Answer Questions

30. $\text{H} : \text{C} \begin{matrix} \cdot\cdot \\ \cdot\cdot \end{matrix} \text{C} : \text{H}$ Electron dot structure of ethyne (C_2H_2)
 $\text{H} - \text{C} \equiv \text{C} - \text{H}$ Structural formula of ethyne
31. (a) Pentanoic acid
(b) Butyne
(c) Heptanal
(d) Pentanol
32. (a) $-\text{OH}$ Hydroxyl/Alcohol
(b) $\begin{matrix} -\text{C}-\text{OH} \\ || \\ \text{O} \end{matrix}$ Carboxylic acid
(c) $\begin{matrix} \text{O} \\ || \\ -\text{C}- \end{matrix}$ Ketone
(d) $\begin{matrix} | & | \\ -\text{C} & = & \text{C}- \end{matrix}$ Alkene
33. (a) Carboxylic acid is ethanoic acid
(b) Alcohol is ethanol
(c) X is ethyl ethanoate

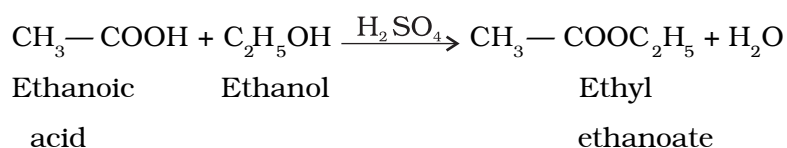

34. Detergents work as cleansing agent both in hard and soft water. The charged ends of detergents do not form insoluble precipitates with calcium and magnesium ions in hard water.

- 35.** (a) Ketone
 (b) Carboxylic acid
 (c) Aldehyde
 (d) Alcohol

36. Ethanol on heating with excess concentrated sulphuric acid at 443 K results in the dehydration of ethanol to give ethene.

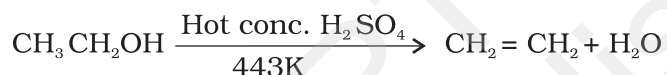

37. Methanol is oxidised to methanal in the liver. Methanal reacts rapidly with the components of cells. It causes the protoplasm to coagulate. It also affects the optic nerve, causing blindness.

38. Gas evolved is hydrogen.

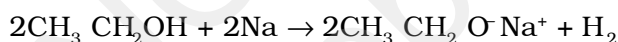

39. Sulphuric acid acts as a dehydrating agent.

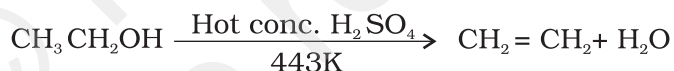

- 40.** (a) Carbon tetrachloride (CCl₄)
 (b) Carbon dioxide (CO₂)

- 41.** (a) K, L, M
 2, 8, 7



42. Carbon exhibits catenation much more than silicon or any other element due to its smaller size which makes the C–C bonds strong while the Si–Si bonds are comparatively weaker due to its large size.

43. Hint— The two can be distinguished by subjecting them to the flame. Saturated hydrocarbons generally give a clear flame while unsaturated hydrocarbons give a yellow flame with lots of black smoke.

44. (a) —(iv) (b) — (i)
 (c) — (ii) (d) — (iii)

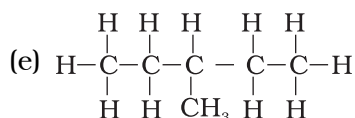
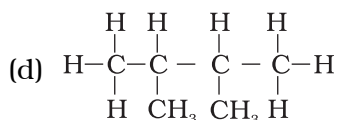
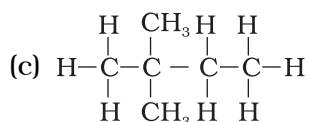
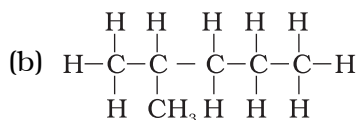
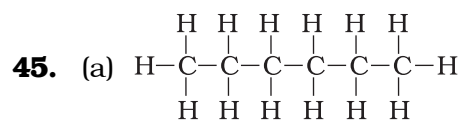

46. **Hint—** (a) Ni acts as a catalyst
 (b) Concentrated H_2SO_4 acts as a catalyst
 (c) Alkaline KMnO_4 acts as an oxidising agent

Long Answer Questions

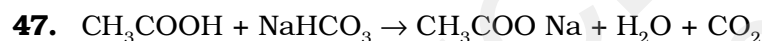

X is sodium ethanoate

Gas evolved is carbon dioxide

Hint— Activity

Lime water will turn milky, a characteristic property of CO_2 gas

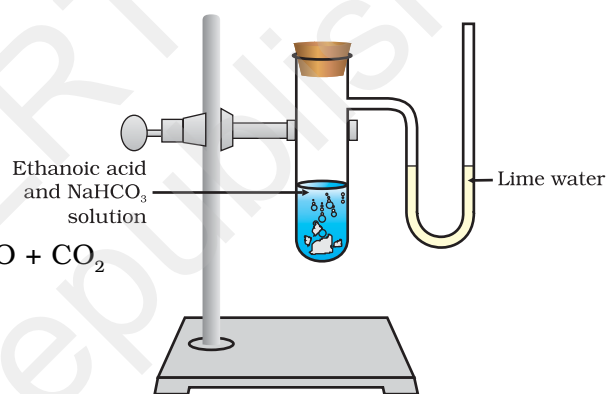

48. (a) Compounds of carbon and hydrogen are called hydrocarbons. Example, methane, ethane etc.
 (b) Saturated hydrocarbons contain carbon- carbon single bonds.
 Unsaturated hydrocarbons contain atleast one carbon - carbon double or triple bond.

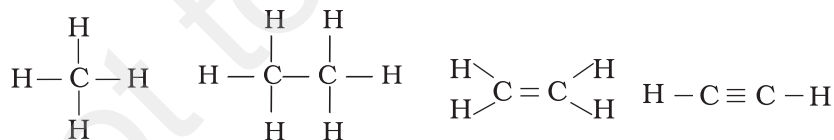

Methane

Ethane

Ethene

Ethyne

Saturated hydrocarbons

Unsaturated hydrocarbons

- (c) Functional group – An atom/group of atoms joined in a specific manner which is responsible for the characteristic chemical properties of the organic compounds. Examples are hydroxyl group ($-\text{OH}$), aldehyde group ($-\text{CHO}$), carboxylic group ($-\text{COOH}$) etc.

49. Hint— Hydrogenation reaction

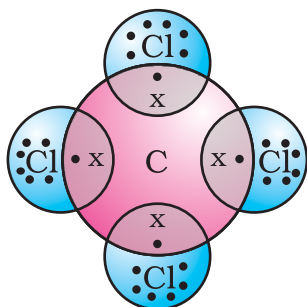
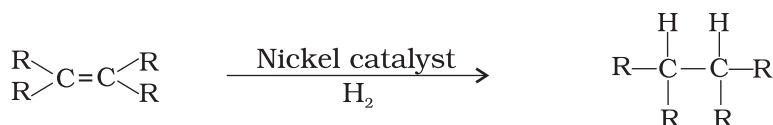

50. a) CCl_4

(b) Saponification is the process of converting esters into salts of carboxylic acids and ethanol by treating them with a base.

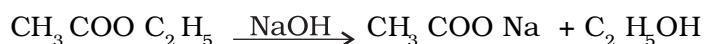

51. Activity

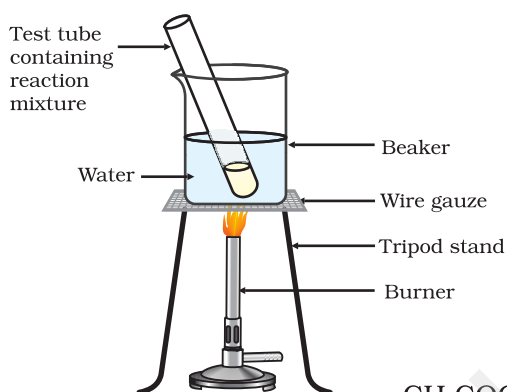

- Take 1 mL ethanol (absolute alcohol) and 1 mL glacial acetic acid along with a few drops of concentrated sulphuric acid in a test tube.
- Warm in a water-bath at about 60°C for at least 15 minutes as shown in the Figure (It should not be heated directly on flame as the vapours of ethanol catch fire)
- Pour into a beaker containing 20-50 mL of water and smell the resulting mixture.



52. C — Ethanoic acid

R — Sodium salt of ethanoic acid (sodium acetate) and gas evolved is hydrogen

A — Methanol

S — Ester (Methyl acetate)

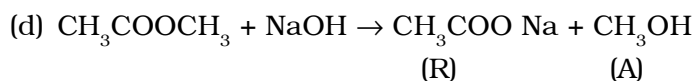
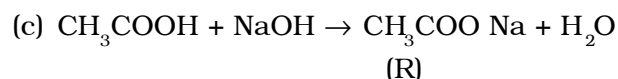
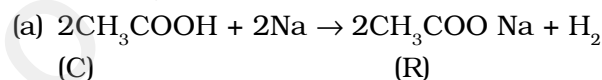

53. (a) It will turn milky

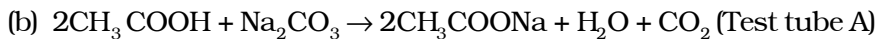

With excess CO_2 , milkiness disappears.

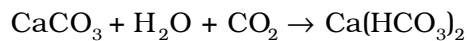

(c) As $\text{C}_2\text{H}_5\text{OH}$ and Na_2CO_3 do not react, a similar change is not expected

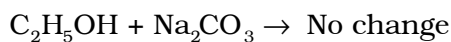

(d) The lime water is prepared by dissolving calcium oxide in water and decanting the supernatant liquid.

54. **Hint—** (a) By the dehydration of ethanol in the presence of concentrated H_2SO_4 .



(b) By the oxidation of propanol using oxidising agent such as alkaline KMnO_4 .



55.

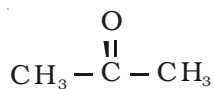

Propanone

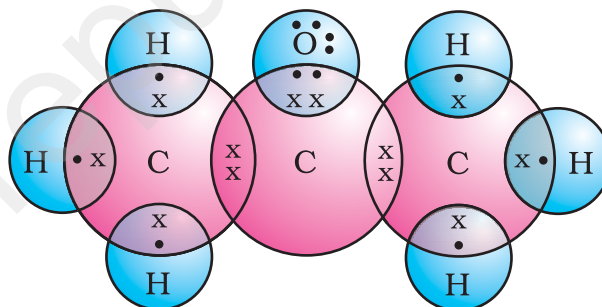

Electron dot structure of propanone



Propanal

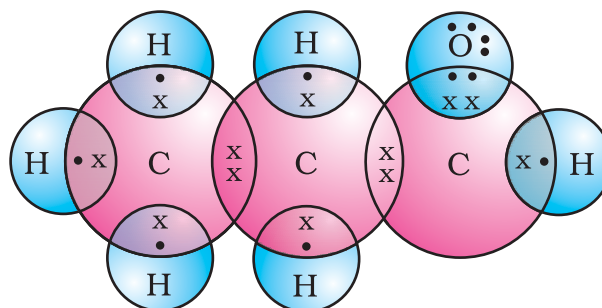

Electron dot structure of propanal

- 56. Hint—** (a) Unsaturated hydrocarbons add hydrogen in the presence of nickel catalyst to give saturated hydrocarbons.

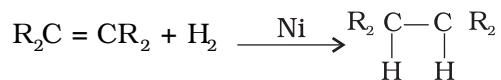

- (b) Ethanol is oxidised to ethanoic acid in the presence of alkaline $KMnO_4$ on heating.



- (c) In the presence of sunlight, chlorine is added to hydrocarbons.

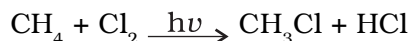

- (d) $CH_3COOC_2H_5 + NaOH \rightarrow CH_3COONa + C_2H_5OH$
Ester

Used in the preparation of soap

- (e) Most carbon compounds release a large amount of heat and light on burning



- 57.** Since compound C gives 2 moles of CO_2 and 3 moles of H_2O , it shows that it has the molecular formula C_2H_6 (Ethane). C is obtained by the addition of one mole of hydrogen to compound B so the molecular formula of B should be C_2H_4 (Ethene). Compound B is obtained by heating compound A with concentrated H_2SO_4 which shows it to be an alcohol. So compound A could be C_2H_5OH (Ethanol)

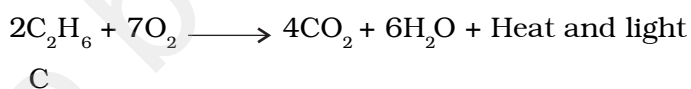
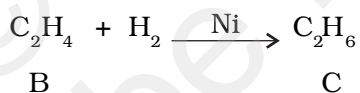
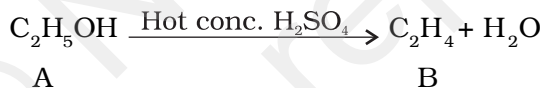

CHAPTER 5

ANSWERS

Multiple Choice Questions

1. (b) 2. (c) 3. (a) 4. (b)
5. (c) 6. (b) 7. (c) 8. (c)
9. (b) 10. (b) 11. (d) 12. (d)
13. (c) 14. (c) 15. (b) 16. (d)
17. (b) 18. (b) 19. (c) 20. (c)
21. (a) 22. (b) 23. (b) 24. (c)
25. (b) 26. (a)

Short Answer Questions

27. The arrangement of these elements is known as Döbereiner triad.
Example, Lithium, Sodium and Potassium
28. (a) (i) F and Cl (ii) Na and K.
(b) Newland's law of octaves
29. (a) No, because all these elements do not have similar properties although the atomic mass of silicon is average of atomic masses of sodium (Na) and chlorine (Cl).
(b) Yes, because they have similar properties and the mass of magnesium (Mg) is roughly the average of the atomic mass of Be and Ca.
30. **Hint**— Elements with similar properties can be grouped together.
31. **Hint**— Hydrogen resembles alkali metals as well as halogens
32. GeCl_4 , GaCl_3

33.

Element	Group No.	Valency
A	Group-13	3
B	Group-14	4
C	Group-2	2

34. XCl_4 ; Covalent bonding
35. **Hint**— Radii of Y is less than X because Y is cation of X
36. (a) $\text{F} < \text{N} < \text{Be} < \text{Li}$
(b) $\text{Cl} < \text{Br} < \text{I} < \text{At}$
37. (a), (b) and (d)
(a) Magnesium (b) Sodium (d) Lithium
38. **Hint**— A B 
- Ionic bond.
A = K (Potassium) B = Cl (Chlorine)
39. $\text{Ge} < \text{Ga} < \text{Mg} < \text{Ca} < \text{K}$
40. (a) Na or K (b) Ca (c) Hg
 $\text{Hg} < \text{Ca} < \text{Na} < \text{K}$
41. (a) Sodium (Na) Group 1 and Period 3 or Potassium (K) Group 1 and Period 4
(b) Phosphorus (P) Group 15 and Period 3
(c) Carbon (C) Group 14 and Period 2
(d) Helium (He) Group 18 and Period 1
(e) Aluminium (Al) Group 13 and Period 3

Long Answer Questions

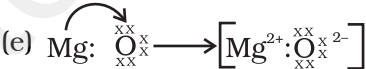
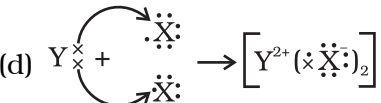
42. (a) Magnesium (Mg)
(b) K, L, M
2, 8, 2
(c) $2\text{Mg}(\text{s}) + \text{O}_2(\text{g}) \rightarrow 2\text{MgO}(\text{s})$
(d) $\text{MgO}(\text{s}) + \text{H}_2\text{O}(\text{l}) \rightarrow \text{Mg}(\text{OH})_2(\text{aq})$
(e) 
43. (a) X belongs to Group 17 and 3rd period
Y belongs to Group 2 and 4th period
(b) X — Non-metal and Y — Metal
(c) Basic oxide; Ionic bonding
(d) 

- 44.** (a) Elements— Neon (Ne), Calcium (Ca), Nitrogen (N), Silicon (Si)
 (b) Group— 18, 2, 15, 14
 (c) Period— 2, 4, 2, 3
 (d) Electron configuration— (2, 8); (2, 8, 8, 2); (2, 5); (2, 8, 4)
 (e) Valency— 0, 2, 3, 4

45.

	¹ M	⁷ A	G	N	E	² S	I	U	M		
		S				O					
		³ T	⁸ I	N		D	⁹ B		⁵ L		
		A	R			⁴ I	O	D	I	⁶ N	E
		T	O			U	R		T	E	
		I	N			M	O		H	O	
		N					N		I	N	
		E							U		
									M		

- 46.** (a) H, He, Li, Be, B, C, N, O, F, Ne, Na, Mg, Al, Si, P, S, Cl, Ar, K, Ca
 (b) Group 1 — H, Li, Na, K
 Group 2 — Be, Mg, Ca
 Group 13 — B, Al
 Group 14 — C, Si
 Group 15 — N, P
 Group 16 — O, S
 Group 17 — F, Cl
 Group 18 — He, Ne, Ar
- 47.** (a) Germanium (Ge) and Gallium (Ga)
 (b) Group 14; Period 4 and Group 13; Period 4
 (c) Ge — Metalloid; Ga — Metal
 (d) Ga — 3 Ge — 4
- 48.** (a) Lithium
 (b) Fluorine
 (c) Fluorine
 (d) Boron
 (e) Carbon

49. (a) Element X is sulphur (atomic no. 16)
 (b) K, L, M
 2, 8, 6
 (c) $2\text{FeSO}_4(\text{s}) \xrightarrow{\text{Heat}} \text{Fe}_2\text{O}_3(\text{s}) + \text{SO}_2(\text{g}) + \text{SO}_3(\text{g})$
 (d) Acidic
 (e) 3rd period, group 16

50. (a) Nitrogen (atomic no. 7)
 2,5; it has 5 valence electrons

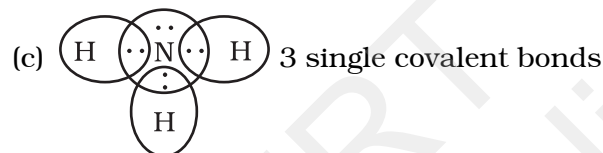
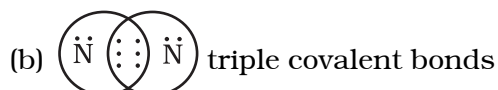

51. Noble gases

According to Mendeleev's classification, the properties of elements are the periodic function of their atomic masses and there is a periodic recurrence of elements with similar physical and chemical properties. Noble gas being inert, could be placed in a separate group without disturbing the original order.

52. (**Hint**— 63 elements were known.)

- Compounds of these elements with oxygen and hydrogen were studied (formation of oxides and hydrides)
- Elements with similar properties were arranged in a group
- Mendelée'ev observed that elements were automatically arranged in the order of increasing atomic masses.



CHAPTER 6

ANSWERS

Multiple Choice Questions

- | | | | |
|----------------|----------------|----------------|----------------|
| 1. (c) | 2. (b) | 3. (a) | 4. (d) |
| 5. (b) | 6. (b) | 7. (b) | 8. (d) |
| 9. (d) | 10. (d) | 11. (b) | 12. (d) |
| 13. (d) | 14. (d) | 15. (d) | 16. (b) |
| 17. (c) | 18. (a) | 19. (b) | 20. (d) |
| 21. (d) | 22. (d) | 23. (a) | 24. (a) |
| 25. (c) | 26. (c) | 27. (c) | 28. (c) |
| 29. (c) | 30. (b) | 31. (c) | 32. (c) |
| 33. (d) | 34. (c) | 35. (a) | |

Short Answer Questions

- 36.** (a) Photosynthesis
(b) Autotrophs
(c) Chloroplast
(d) Guard Cells
(e) Heterotrophs
(f) Pepsin
- 37.** During day time, as the rate of photosynthesis is more than the rate of respiration, the net result is evolution of oxygen. At night there is no photosynthesis, so they give out carbon dioxide due to respiration.
- 38.** The swelling of guard cells due to absorption of water causes opening of stomatal pores while shrinking of guard cells closes the pores. Opening and closing of stomata occurs due to turgor changes in guard cells. When guard cells are turgid, stomatal pore is open while in flaccid conditions, the stomatal aperture closes.
- 39.** Plant kept in continuous light will live longer, because it will be able to produce oxygen required for its respiration by the process of photosynthesis.

40. Release of CO_2 and intake of O_2 gives evidence that either photosynthesis is not taking place or its rate is too low. Normally during day time, the rate of photosynthesis is much more than the rate of respiration. So, CO_2 produced during respiration is used up for photosynthesis hence CO_2 is not released.

41. Fishes respire with the help of gills. Gills are richly supplied with blood capillaries and can readily absorb oxygen dissolved in water. Since fishes cannot absorb gaseous oxygen they die soon after they are taken out of water.

42.

Autotroph	Heterotroph
1. Organisms that prepare their own food.	1. Organisms that are dependent on other organisms for food.
2. They have chlorophyll.	2. They lack chlorophyll.

43. Food is required for the following purposes

- It provides energy for the various metabolic processes in the body.
- It is essential for the growth of new cells and repair or replacement of worn out cells.
- It is needed to develop resistance against various diseases.

44. Green plants are the sources of energy for all organisms. If all green plants disappear from the earth, all the herbivores will die due to starvation and so will the carnivores.

45. This plant will not remain healthy for a long time because

- it will not get oxygen for respiration.
- it will not get carbon dioxide for photosynthesis.
- Upward movement of water and minerals would be hampered due to lack of transpiration.

46.

Aerobic respiration	Anaerobic respiration
1. Oxygen is utilised for the breakdown of respiratory substrate.	1. Oxygen is not required.
2. It takes place in cytoplasm (glycolysis) and inside mitochondria (Krebs cycle)	2. It takes place in cytoplasm only.
3. End products are carbon dioxide and water	3. End products are lactic acid or ethanol and carbon dioxide.
4. More energy is released.	4. Less energy is released.

47. (a) (ii) (b) (i) (c) (iv) (d) (iii)

48.

Artery	Vein
<ol style="list-style-type: none">1. Have thick elastic, muscular walls.2. Lumen is narrow.3. Carry blood from heart to all body parts.4. Carry oxygenated blood (except pulmonary artery).	<ol style="list-style-type: none">1. Have thin, non-elastic, walls.2. Lumen is wide.3. Carry blood from all body parts to heart.4. Carry deoxygenated blood (except pulmonary vein).

49. (a) Leaves provide large surface area for maximum light absorption.
- (b) Leaves are arranged at right angles to the light source in a way that causes overlapping.
- (c) The extensive network of veins enables quick transport of substances to and from the mesophyll cells.
- (d) Presence of numerous stomata for gaseous exchange.
- (e) The chloroplasts are more in number on the upper surface of leaves.
50. Digestion of cellulose takes a longer time. Hence, herbivores eating grass need a longer small intestine to allow complete digestion of cellulose. Carnivorous animals cannot digest cellulose, hence they have a shorter intestine.
51. Gastric glands in stomach release hydrochloric acid, enzyme pepsin and mucus. Mucus protects the inner lining of stomach from the action of hydrochloric acid and enzyme pepsin. If mucus is not released, it will lead to erosion of inner lining of stomach, leading to acidity and ulcers.
52. Fats are present in food in the form of large globules which makes it difficult for enzymes to act on them. Bile salts present in bile break them down mechanically into smaller globules which increases the efficiency of fat digesting enzymes.
53. The wall of alimentary canal contains muscle layers. Rhythmic contraction and relaxation of these muscles pushes the food forward. This is called peristalsis, which occurs all along the gut.
54. Maximum absorption occurs in small intestine because
- (a) digestion is completed in small intestine
- (b) inner lining of small intestine is provided with villi which increases the surface area for absorption.
- (c) wall of intestine is richly supplied with blood vessels (which take the absorbed food to each and every cell of the body).

- 55.** (a) — (iv) (b) — (iii)
(c) — (i) (d) — (ii)
- 56.** Aquatic organisms like fishes obtain oxygen from water present in dissolved state through their gills. Since the amount of dissolved oxygen is fairly low compared to the amount of oxygen in the air, the rate of breathing in aquatic organisms is much faster than that seen in terrestrial organisms.
- 57.** The blood circulation in human heart is called double circulation because the blood passes through the heart twice in one complete cycle of the body – once through the right half in the form of deoxygenated blood and once through the left half in the form of oxygenated blood.
- 58.** In four chambered heart, left half is completely separated from right half by septa. This prevents oxygenated and deoxygenated blood from mixing. This allows a highly efficient supply of oxygenated blood to all parts of the body. This is useful in animals that have high energy needs, such as birds and mammals.
- 59.** The major events during photosynthesis are
(a) absorption of light energy by chlorophyll
(b) conversion of light energy to chemical energy
(c) splitting of H_2O into H_2 , O_2 and e^-
(d) reduction of CO_2 to carbohydrates
- 60.** (a) Decreases
(b) Decreases
(c) Increases
(d) Decreases
- 61.** Adenosine triphosphate (ATP) produced during respiration in living organisms and also during photosynthesis in plants.
- 62.** All are parasites, they derive nutrition from plants or animals without killing them.
- 63.** (a) Food is crushed into small pieces by the teeth.
(b) It mixes with saliva and the enzyme amylase (found in saliva) breaks down starch into sugars.
(c) Tongue helps in thorough mixing of food with saliva.
- 64.** (a) Production of pepsin enzyme that digests proteins
(b) Secretion of Mucus for protection of inner lining of stomach.
- 65.** (a) — i, (b) — iv, (c) — ii, (d) — iii

66. (a)— Protein (b)— Starch (c)— Protein (d)— Fats
67. Arteries carry blood from the heart to various organs of the body under high pressure so they have thick and elastic walls. Veins collect the blood from different organs and bring it back to the heart. The blood is no longer under pressure so the walls are thin with valves to ensure that blood flows only in one direction.
68. In the absence of platelets, the process of clotting will be affected.
69. Plants do not move. In a large plant body there are many dead cells like schlerenchyma as a result it requires less energy as compared to animals.
70. Cells of root are in close contact with soil and so actively take up ions. The ion-concentration, increases inside the root and hence osmotic pressure increases the movement of water from the soil into the root which occurs continuously.
71. Transpiration is important because
- (a) it helps in absorption and upward movement of water and minerals from roots to leaves
 - (b) it prevents the plant parts from heating up.
72. Many plants store waste materials in the vacuoles of mesophyll cells and epidermal cells. When old leaves fall, the waste materials are excreted along with the leaves.

Long Answer Questions

73. **Hints—** Finger like projections
Food vacuoles
Diffusion of simpler substances.
74. **Hints—** Mouth cavity
Oesophagus
Stomach
Intestine
75. **Hints—** 1. Passage of air
2. Gaseous exchange
3. Role of diaphragm
4. Function of rib muscles and alveoli
76. **Hints—** 1. Anchoring the plant
2. Source of water and minerals
3. Availability of oxygen for respiration of root cells
4. Symbiotic association with microbes

77.

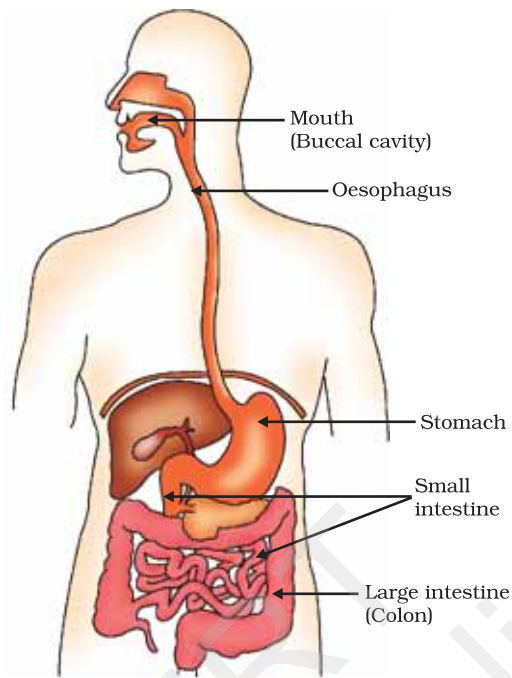

Alimentary canal of man

78. **Hints—** Mouth cavity

Stomach

Intestine

79. **Hints—** Absorption of light energy by chlorophyll

Conversion of light energy into chemical energy

Reduction of CO_2 into carbohydrates.

80. **Hints—** Pyruvate to ethanol, CO_2 and energy

Pyruvate to lactic acid and energy

Pyruvate to CO_2 , H_2O and energy

81. **Hints—** Atrium

Ventricles

Oxygenated blood

De-oxygenated blood

82. **Hints—** Nephrons

Filtration

Selective reabsorption

CHAPTER 7

ANSWERS

Multiple Choice Questions

- | | | | |
|----------------|----------------|----------------|----------------|
| 1. (a) | 2. (c) | 3. (d) | 4. (b) |
| 5. (d) | 6. (c) | 7. (c) | 8. (b) |
| 9. (b) | 10. (d) | 11. (c) | 12. (d) |
| 13. (b) | 14. (b) | 15. (a) | 16. (c) |
| 17. (c) | 18. (b) | 19. (a) | 20. (c) |
| 21. (b) | 22. (c) | 23. (d) | 24. (b) |
| 25. (c) | 26. (a) | 27. (b) | 28. (c) |
| 29. (d) | 30. (b) | 31. (c) | 32. (d) |
| 33. (d) | | | |

Short Answer Questions

- 34.** (a) Sensory neuron
(b) Spinal cord (CNS)
(c) Motor neuron
(d) Effector = Muscle in arm
- 35.** (a) Auxin
(b) Gibberellin
(c) Cytokinin
(d) Abscisic acid
- 36.** (a) Pineal gland
(b) Pituitary gland
(c) Thyroid
(d) Thymus
- 37.** Figure (a) is more appropriate because in a plant shoots are negatively geotropic hence, grow upwards and roots are positively geotropic so grow downwards.

- 38.** (a) Dendrite
(b) Cell body
(c) Axon
(d) Nerve ending
- 39.** (a) — (iii) (b) — (iv)
(c) — (i) (d) — (ii)
- 40.** The directional growth movements of plants due to external stimuli are called tropic movement. It can be either towards the stimulus, or away from it. For example, in case of phototropic movement, shoots respond by bending towards light while roots respond by bending away from it.
- 41.** (a) When iodine intake is low, release of thyroxin from thyroid gland will be less by which protein, carbohydrate and fat metabolisms will be affected.
(b) A person might suffer from goitre in case of iodine deficiency in the body.
- 42.** When an electrical signal reaches the axonal end of one neuron it releases certain chemical substances that cross the synapse and move towards the dendritic end of next neuron generating another electrical signal.
- 43.** (a) Oestrogen
(b) Growth hormone
(c) Insulin
(d) Thyroxin
- 44.** (a) Pituitary
(b) Pancreas
(c) Adrenal
(d) Testes

Long Answer Questions

- 45. Hints—** Cell body
Dendrite
Axon
- 46. Hints—** Fore brain
Mid brain
Hind brain
Give its functions

47. Hints— Brain and spinal cord

Brain box and vertebral column.

48. (a) Thyroxin regulates carbohydrate, fat and protein metabolisms

(b) Insulin — regulates blood sugar

(c) Adrenaline — increases heart rate and supply of blood to various organs

(d) Growth hormone — regulates growth and development

(e) Testosterone — controls the changes of body features associated with puberty in male

49. Hints— Auxin

Gibberellin

Cytokinin

Abscisic acid

50. Hints— Definition

Nerve impulses

51. Hints— Nerve impulses

Dendritic end and axonal end

Role of hormones

Roles of blood, muscles and glands.

52. Different endocrine glands secrete different hormones. These hormones are released into blood which carry them to specific tissues or organs called target tissues or target organs. In the target tissues, hormone triggers a particular biochemical or physiological activity.

53. When an electrical signal reaches the axonal end of a neuron, it releases a chemical substance. This chemical diffuses towards the dendrite end of next neuron where it generates an electrical impulse or signal. Hence, the electrical signal is converted into a chemical signal at the axonal end. Since these chemicals are absent at the dendrite end of the neuron the electrical signal, cannot be converted into chemical signal.



CHAPTER 8

ANSWERS

Multiple Choice Questions

- | | | | |
|----------------|----------------|----------------|----------------|
| 1. (b) | 2. (c) | 3. (c) | 4. (a) |
| 5. (d) | 6. (c) | 7. (a) | 8. (a) |
| 9. (d) | 10. (a) | 11. (b) | 12. (b) |
| 13. (b) | 14. (c) | 15. (b) | 16. (d) |
| 17. (b) | 18. (c) | 19. (c) | 20. (b) |
| 21. (d) | 22. (c) | 23. (d) | 24. (b) |
| 25. (c) | 26. (a) | 27. (b) | |

Short Answer Questions

- 28.** The pistil is intact. Cross pollination has occurred leading to fertilisation and formation of fruit.
- 29.** Yes, because it results in the formation of two daughter cells, that is, it results in the production of more individuals of the organism.
- 30.** Clone refers to offspring of an organism formed by asexual method of reproduction. Since they possess exact copies of the DNA of their parent, clones exhibit remarkable similarity.
- 31.** Reduction division (meiosis) during gamete formation halves the chromosome number in both male and female gametes. Since these two gametes fuse during fertilisation, the original number of chromosomes (as in the parent) is restored in the offspring.
- 32.** Sugar provides energy for sustaining all life activities in yeasts. In water, it fails to reproduce because of inadequate energy in its cells.
- 33.** Moisture is an important factor for the growth of hyphae. Moistened bread slice offers both moisture and nutrients to the bread mould, hence it grows profusely. Dry slice of bread offers nutrients but not moisture hence hyphae fail to grow.

- 34.** (a) Sexual reproduction involves two parents with different sets of characters
 (b) The gene combinations are different in gametes.
- 35.** Yes, shaded part in Figures D and E represent the regenerated halves.
- 36.** (a) No, there is no relationship between size of organism and its chromosome number.
 (b) No, process of reproduction follows a common pattern and is not dependent on the number of chromosomes
 (c) Yes, since the major component of chromosome is DNA, if there are more chromosomes in a cell, the quantity of DNA will also be more.
- 37.** Number of chromosomes in female gamete is 24
 Number of chromosomes in zygote is 48
- 38.** In a flower fertilisation requires both male and female gametes.
 If pollination does not occur, male gamete is not available hence fertilisation cannot take place.
- 39.** Yes, the constancy is maintained because cells in all these three structures undergo only mitotic divisions.
- 40.** Zygote is located inside the ovule which is present in the ovary.
- 41.** In reproduction, DNA passes from one generation to the next. Copying of a DNA takes place with consistency but with minor variations. This consistency leads to stability of species.
- 42.** General growth refers to different types of developmental process in the body like increase in height, weight gain, changes in shape and size of the body but sexual maturation is specific to changes reflected at puberty like cracking of voice, new hair patterns, development of breast in female etc.
- 43.** Sperm comes out from testis into the vas deferens and then passes through urethra before ejaculation. The secretions of seminal vesicle and prostate glands provide nutrition to the sperms and also facilitate their transport.
- 44.** The thick and spongy lining of the uterus slowly breaks and comes out through the vagina as blood and mucus.
- 45.** The uterine wall thickens that is richly supplied with blood. A special tissue called placenta develops which connects embryo to the uterine wall that provides nutrients and oxygen to it.

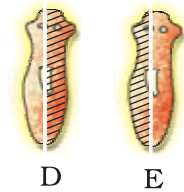

- 46.** Mechanical barriers like condom prevents the sperms from reaching the egg. Thus it is an effective method to avoid pregnancy. It also prevents transmission of infections during sexual act.

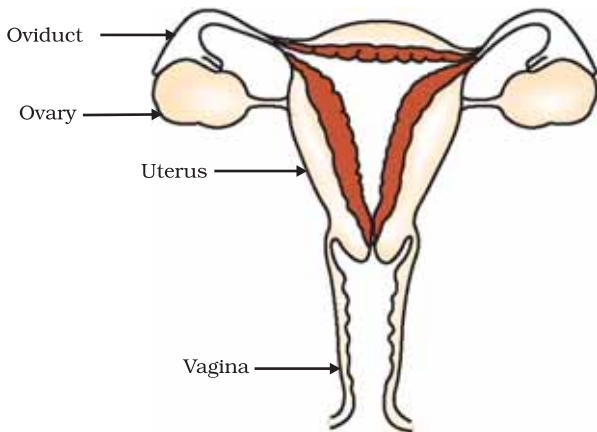

- 47.** (a) Ovary (production of egg)
 (b) Oviduct (site of fertilisation)
 (c) Uterus (site of implantation)
 (d) Vagina (entry of the sperms)

- 48.** The ratio is 1 : 2. Sperms contain either X or Y chromosome whereas an egg will always have an X chromosome.

Long Answer Questions

- 49.** Budding, fragmentation and regeneration are considered as asexual types of reproduction because all of them involve only one parent and gametes are not involved in reproduction



Regeneration in Planaria

50.

Asexual reproduction	Sexual reproduction
(a) Involves only one parent	(i) Often involves two parents
(b) Gametes are not produced	(ii) Gametes are produced
(c) No fertilisation and zygote formation	(iii) Fertilisation and zygote formation is observed.
(d) Meiosis does not occur at anytime during reproduction	(iv) Meiosis occurs at the time of gamete formation

During sexual reproduction two types of gametes fuse. Although the gametes contain the same number of chromosomes, their DNA is not identical. This situation generates variations among the offsprings.

51. The process or mechanism of transfer of pollen grains from the anther to the stigma is termed pollination.

The fusion of male and female gametes giving rise to zygote is termed fertilisation

The site of fertilisation is ovule.

The product of fertilisation is zygote.

52. Gamete represents the sex cell or germ cell in sexual reproduction. There are two types of gametes, male and female.

Zygote is the product of fertilisation in which a male and a female gamete fuse with each other.

The two fusing gametes possess characters of their parents in their DNA. Fertilisation brings characters of both parents into one zygote cell.

Zygote is the first cell of the next generation. It divides to form an embryo which subsequently grows into a new individual.

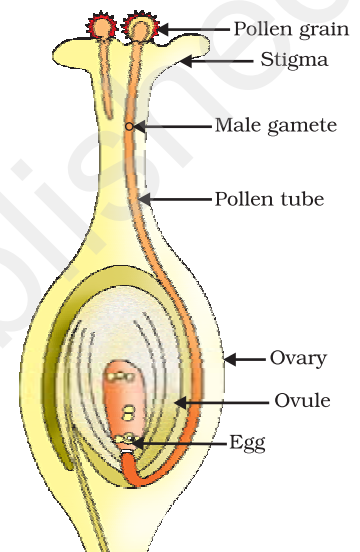

Pollen tube growth and its entry into the ovule

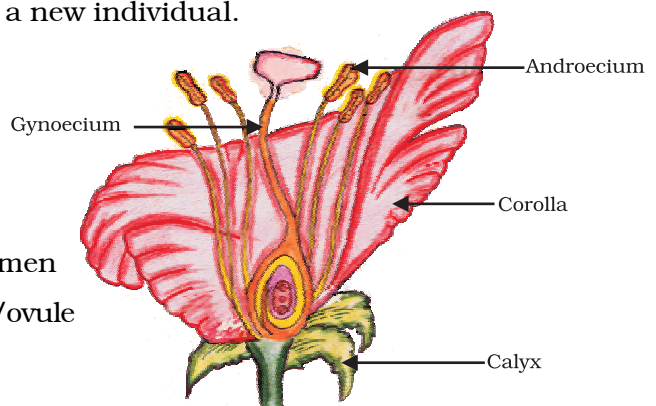

Male gamete forming part – anther/stamen

Female gamete forming part – pistil/ovary/ovule

53.

54. Hints—

- (a) Special tissue connection between embryo and uterine wall
- (b) Possesses villi that increases the surface area.
- (c) Facilitate passage of nutrition and oxygen to embryo from mother through blood.
- (d) Waste substances produced by embryo are removed through placenta into mother's blood.

55. Hints—

- (a) Contraceptive methods are used such as (i) mechanical (ii) drugs (as pills) (iii) loop or copper T and (iv) surgical method.
- (b) Pills change the hormonal balance and thus prevent the release of egg, hence fertilisation is prevented.

56. Hints—

- (a) Sperm enters through the vaginal passage during sexual intercourse and moves upwards.
- (b) Egg released from the ovary reaches the oviduct.
- (c) Sperm encounters egg in the oviduct and fertilization takes place.
- (d) Egg is released once every month by ovary.

57. Hints—

- (a) Organisms need energy for survival which they obtain from life processes such as nutrition and respiration.
- (b) Reproduction needs a lot of energy.
- (c) Genetic material is transferred from one generation to the next as a result of reproduction through DNA copying.
- (d) DNA copying takes place with high constancy and considerable variations, that is, advantages to the species for stability in the changing environment.

58. Hints—

- (a) These are infectious diseases transmitted during sexual contact.
- (b) They may be bacterial like or viral like.
- (c) Use of mechanical barrier like condom prevents transmission of infection.



CHAPTER 9

ANSWERS

Multiple Choice Questions

1. (c) 2. (b) 3. (a) 4. (d)
5. (a) 6. (c) 7. (b) 8. (b)
9. (b) 10. (a) 11. (b) 12. (c)
13. (a) 14. (b) 15. (a) 16. (c)
17. (a) 18. (b) 19. (c) 20. (a)
21. (b) 22. (c) 23. (a) 24. (b)
25. (d)

Short Answer Questions

26. The sex of the individual is genetically determined i.e., genes inherited from parents decide whether the new born will be a boy or a girl. A new born who inherits an 'X' chromosome from father will be a girl and one who inherits a 'Y' chromosome will be a boy.
27. No, because mothers have a pair of X-chromosomes. All children will inherit an 'X' chromosome from their mother regardless of whether they are boys or girls.
28. (a) Fossils represent modes of preservation of ancient species.
(b) Fossils help in establishing evolutionary traits among organisms and their ancestors.
(c) Fossils help in establishing the time period in which organisms lived.
29. Human females have two X chromosomes called sex chromosomes. During meiosis at the time of gamete formation, one X chromosome enters each gamete. Hence all the gametes possess an X chromosome.
30. The sex of an infant is determined by the type of sex chromosome contributed by the male gamete. Since the ratio of male gametes containing X chromosome and those containing Y chromosome is 50 : 50, the statistical probability of male or a female infant is also 50 : 50.

- 31.** Fewer individuals in a species impose extensive inbreeding among them. This limits the appearance of variations and puts the species at a disadvantage if there are changes in the environment. Since the individuals fail to cope up with the environmental changes, they may become extinct.
- 32.** Structures which have a common basic structure but perform different functions are called homologous structures. e.g. fore limbs of reptiles, amphibians and mammals. Yes, they have common ancestor but variously modified to carry out different activities.
- 33.** Though animals have a vast diversity in structures they probably do not have a common ancestry, because common ancestry may greatly limit the extent of diversity. As many of these diverse animals are inhabiting the same habitat, their evolution by geographical isolation and speciation is also not likely. Thus, a common ancestry for all the animals is not the likely theory.
- 34.** (a) yellow — dominant
green — recessive
(b) round — dominant
wrinkled — recessive
- 35.** (a) Easy to grow
(b) Short life span
(c) Easily distinguishable characters
(d) Larger size of flower
(e) Self pollinated
- 36.** ((a) The woman produces ova with 'X' chromosome
(b) The man produces sperms with X and Y chromosome which actually determines the sex of the baby.

Long Answer Questions

- 37.** Yes, geographical isolation gradually leads to genetic drift. This may impose limitations to sexual reproduction of the separated population. Slowly the separated individuals will reproduce among themselves and generate new variations. Continuous accumulation of those variations through a few generations may ultimately lead to the formation of a new species.
- 38.** This is a debatable issue. If appearance of complexity is concurrent with evolution then, human beings are certainly more evolved than bacteria. But if we take the totality of life characteristics into account, then it is hard to label either organism as evolved.

39. Hints— Common body plan, structure, physiology and metabolism.

Constant chromosome number

Common genetic blue print

Freely inter-breeding

40. Characters that are passed on from parents to offspring are inherited characters e.g., colour of seeds, colour of eyes.

Characters appearing in an individual's life time but cannot be transmitted to next generation are acquired characters e.g., obese body, loss of a finger in an accident.

41. Acquired characters do not produce change in the DNA of germ cells, so they cannot be inherited. Only those characters which have a gene for them can be inherited.

42. We see immense diversity in size, form, structure and morphological features in the living world. But at the molecular level these, diverse types of organisms exhibit unbelievable similarity. For instance, the basic biomolecules like DNA, RNA, carbohydrates, proteins etc. exhibit remarkable similarity in all organisms.

43. (a) Round, yellow

(b) Round, yellow

Round, green

Wrinkled, yellow

Wrinkled, green

(c) Wrinkled, green

(d) Round, yellow

44. Rr Yy Round, yellow

45. (i) Round yellow — 9

(ii) Round green — 3

(iii) Wrinkled yellow — 3

(iv) Wrinkled green — 1

9 : 3 : 3 : 1

46. (i) Characters are controlled by genes.

(ii) Each gene controls one character

(iii) There may be two or more forms of the gene

(iv) One form may be dominant over the other

(v) Genes are present on chromosomes

(vi) An individual has two forms of the gene whether similar or dissimilar

(vii) The two forms separate at the time of gamete formation

(viii) The two forms are brought together in the zygote

47. The tall/short and round/wrinkled seed trait are independently inherited.

CHAPTER 10

ANSWERS

Multiple Choice Questions

- | | | | |
|---------|---------|---------|---------|
| 1. (a) | 2. (b) | 3. (c) | 4. (a) |
| 5. (b) | 6. (a) | 7. (d) | 8. (a) |
| 9. (a) | 10. (b) | 11. (b) | 12. (b) |
| 13. (d) | 14. (b) | 15. (d) | 16. (d) |
| 17. (a) | 18. (c) | 19. (d) | |

Short Answer Questions

20. (a) concave mirror
(b) convex lens
(c) concave lens
(d) convex mirror
21. **Hint**— Draw the diagram and explain using laws of refractions at both the interfaces.
22. **Hint**— No. Bending will be different in different liquids since velocity of light at the interface separating two media depends on the relative refractive index of the medium.
23. **Hint**— $n = \frac{c}{v}$
 $n_{21} = \frac{v_1}{v_2}$
24. **Hint**— $n_{dg} = \frac{v_g}{v_d} = 1.6$, $n_g = \frac{c}{v_g}$, and $n_d = \frac{c}{v_d}$
- Therefore, $\frac{v_g}{v_d} \times \frac{c}{v_g} = n_d = 1.6 \times 1.5 = 2.40$.
25. **Hint**— Statement is correct if the object is placed within 20 cm from the lens in the first case and between 20 cm and 40 cm in the second case.

26. Hint— Sudha should move the screen towards the lens so as to obtain a clear image of the building. The approximate focal length of this lens will be 15 cm.

27. $P = \frac{1}{f}$, $P \propto \frac{1}{f}$. Power of a lens is inversely proportional to its focal length therefore lens having focal length of 20 cm will provide more convergence.

28. When two plane mirrors are placed at right angle to each other then the incident and reflected rays will always be parallel to each other.

29. Hint—

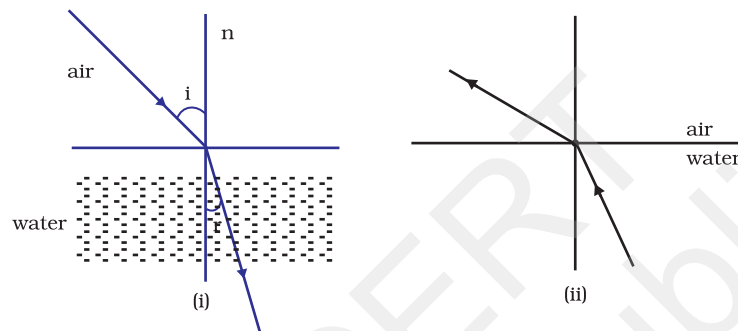

Long Answer Questions

30. Hint— Draw ray diagrams separately indicating the direction of incident and reflected rays.

31. Hint— Draw ray diagrams separately indicating the direction of incident.

32. Hint— Draw ray diagrams indicating the direction of incident, refracted and emergent rays and explain.

33. Hint— Draw ray diagrams separately indicating the direction of incident and refracted rays.

34. Hint— Draw ray diagrams indicating the direction of incident ray and reflected ray.

35. Hint— $m = -\frac{v}{u} = -3$, using $\frac{1}{v} - \frac{1}{u} = \frac{1}{f}$ calculate u .

$u = -\frac{80}{3}$ cm, image is real and inverted. The lens is convex.

36. $m = \frac{1}{3}$. Using $\frac{1}{v} + \frac{1}{u} = \frac{1}{f}$ calculate u ; $u = -80$ cm. Image is real and inverted. Mirror is concave.

37. Hint — $P = \frac{1}{f}$ where f is in metre. Its unit is Dioptre. Lens is convex in the first case and concave in the second case. Power is equal to 2 dioptre in the first case and -2 dioptre in the second case.

38. Hint—

(i) Focal length = $\frac{38}{2} = 19$ cm

(ii) The image will be formed at infinity

(iii) Virtual and erect

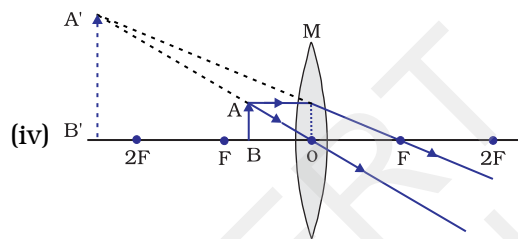

CHAPTER 11

ANSWERS

Multiple Choice Questions

- | | | | |
|---------|---------|---------|---------|
| 1. (b) | 2. (a) | 3. (b) | 4. (a) |
| 5. (c) | 6. (b) | 7. (c) | 8. (c) |
| 9. (b) | 10. (b) | 11. (c) | 12. (b) |
| 13. (a) | 14. (c) | | |

Short Answer Questions

15.

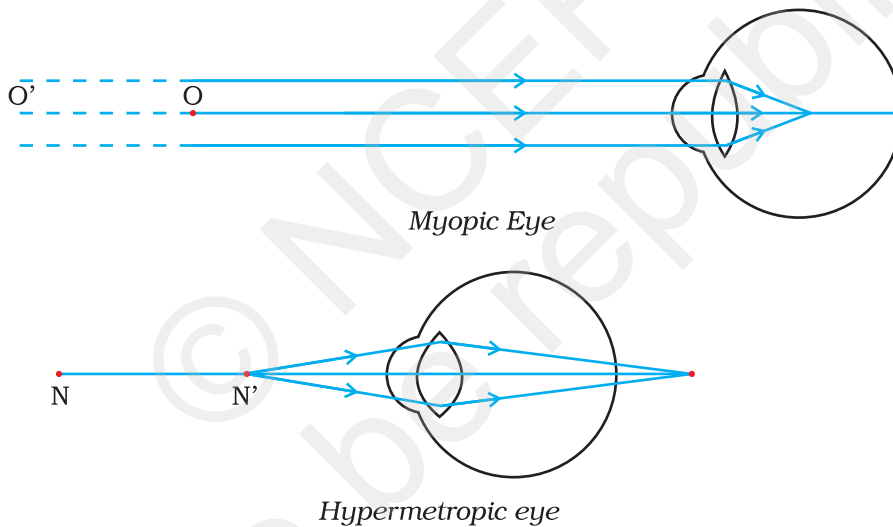

16. **Hint—** The student is suffering from myopia (near sightedness). Doctor advises her to use a concave lens of appropriate power to correct this defect.

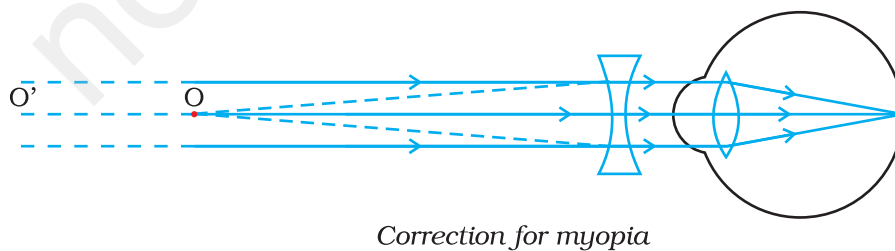

17. **Hint**— Human eye is able to see nearby and distant objects clearly by changing the focal length of the eye lens using its power of accommodation

18. (a) Myopia

(b) **Hint**— $f = \frac{1}{-4.5} = -\frac{2}{9} = -0.22 \text{ m}$,

(c) Concave lens

19. **Hint**— By using two identical prisms, one placed inverted with respect to the other.

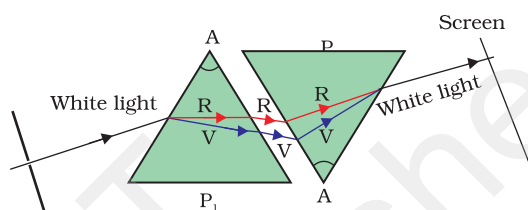

20.

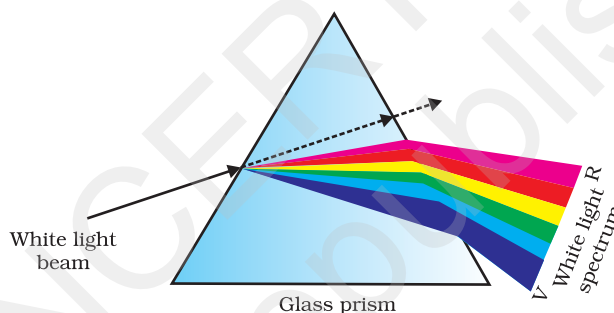

21. No. light from stars undergoes atmospheric refraction which occurs in medium of gradually changing refractive index.

22. **Hint**— The water droplets behave like prisms and disperse sunlight.

23. **Hint**— Blue colour gets scattered the maximum.

24. **Hint**— During sunrise and sunset the sun appears reddish whereas at noon the sun appears white. Explanation should be given in terms of atmospheric depth travelled by light. Colours are different due to scattering of light by atmospheric particles.

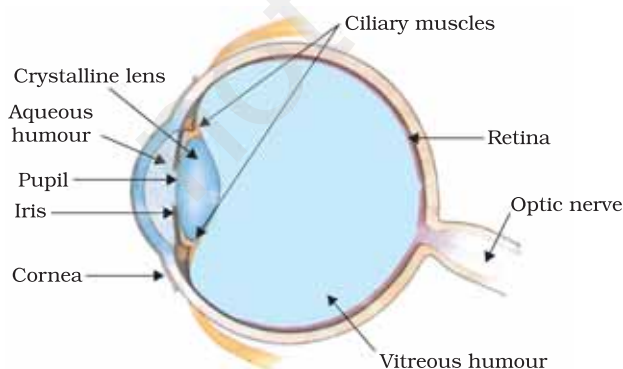

Long Answer Questions

25. **Hint**— Give explanation of each part and discuss power of accommodation.

26. Hint— When a person is not able to see distant objects clearly but can see nearby objects clearly then he is considered to be myopic. If it is otherwise, he is hypermetropic. Give explanation based on figures.

27. Give explanation based on Figure. Angle of deviation is the angle D , between the incident ray and the emergent ray when a ray of light passes through a glass prism.

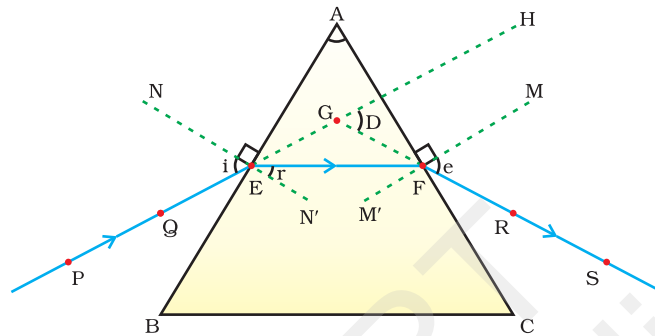

28. Hint— Sun appears reddish at sunrise or sunset as blue light gets scattered away.

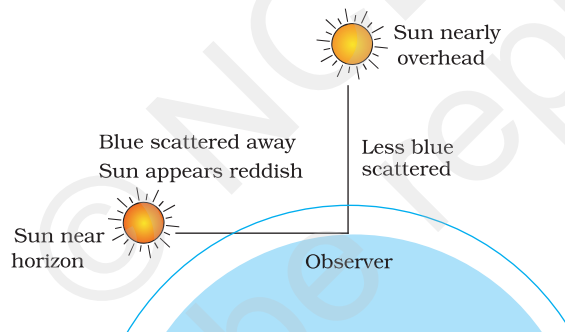

29. Give explanation using the Figure.

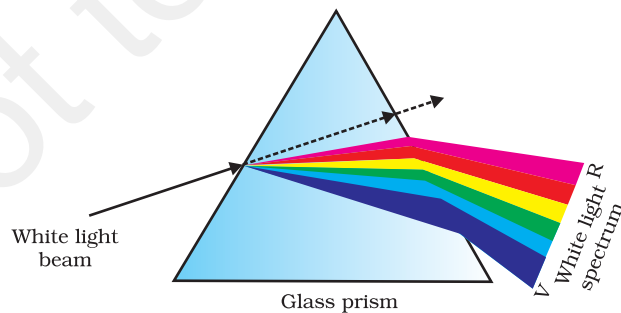

30. Hint— Give explanation using the Figure. Planets do not twinkle as they are closer to earth and are seen as extended sources.

CHAPTER 12

ANSWERS

Multiple Choice Questions

- | | | | |
|---------|---------|---------|---------|
| 1. (b) | 2. (a) | 3. (d) | 4. (a) |
| 5. (b) | 6. (d) | 7. (b) | 8. (a) |
| 9. (a) | 10. (c) | 11. (c) | 12. (c) |
| 13. (c) | 14. (c) | 15. (c) | 16. (d) |
| 17. (b) | 18. (a) | | |

Short Answer Questions

19.

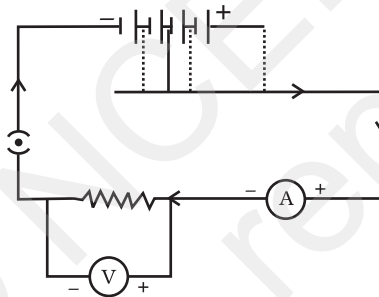

20. Maximum current through resistor A = $\sqrt{\frac{18}{2}}$ A = 3 A.

Thus the maximum current through resistors B and C each

$$3 \times \frac{1}{2} \text{ A} = 1.5 \text{ A}.$$

21. **Hint—** It should be as close to zero as possible. Ideally it should be zero ohm. If it is non-zero and substantial it will affect the true current.

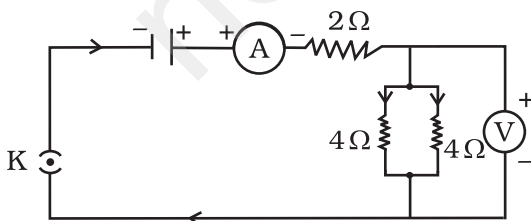

22. **Hint—** Yes. Total resistance of the parallel combination is also 2 ohm (2 Ω).

- 23. Hint—** If a current larger than a specified value flows in a circuit, temperature of fuse wire increases to its melting point. The fuse wire melts and the circuit breaks.
- 24. Hint—** Use the formula $R = \rho \frac{l}{A}$. Also, $V = RI$. R is doubled while V remains unchanged. Hence current becomes $\frac{I}{2}$.
- 25.** kW h. $1 \text{ kW h} = 1000 \text{ W} \times 60 \times 60 \text{ s} = 3.6 \times 10^6 \text{ J}$
- 26.** (i) 5Ω (ii) **Hint—** Calculate the total resistance of the circuit. There will be no change in current flowing through 5Ω conductor. Also there will be no change in potential difference across the lamp either.
- 27. Hint—** Provide the same potential difference across each electrical appliance.
- 28. Hint—** (i) The glow of the bulbs B_2 and B_3 will remain the same.
(ii) A_1 shows 1 ampere, A_2 shows zero, A_3 shows 1 ampere and A shows 2 ampere
(iii) $P = VI = 4.5 \times 3 = 13.5 \text{ W}$

Long Answer Questions

- 29.** (a) No. The resistance of the bulbs in series will be three times the resistance of single bulb. Therefore, the current in the series combination will be one-third compared to current in each bulb in parallel combination. The parallel combination bulbs will glow more brightly.
(b) The bulbs in series combination will stop glowing as the circuit is broken and current is zero. However the bulbs in parallel combination shall continue to glow with the same brightness.
- 30. Hint—** Define Ohm's law. Give details of experiment using a labelled circuit diagram. Support your answer giving relation between V and I and a graph depicting Ohm's law. Ohm's law does not hold under all conditions. Mention the conditions.
- 31. Hint—** Resistivity is numerically equal to the resistance of a wire of unit length having an unit area of cross-section. Its unit is ohm metre ($\Omega \text{ m}$). Mention the dependence of resistance on length and area of cross section of the wire giving details of experiment using a circuit diagram.
- 32. Hint—** Describe the experiment using a circuit diagram. Give details showing that same current flows through each component in a series circuit.

33. Hint— Describe the experiment using a circuit diagram. Give details showing that same potential difference exists across each resistance in a parallel circuit.

34. Hint— Joule's heating effect, $H = I^2 R t$. Describe the experiment using a circuit diagram. Applications: electric heater, geyser, laundry iron, electric oven, bulb, toaster, kettle etc.

35. (a) 4 Ω . Hint— $R = R_1 R_2 / (R_1 + R_2) = \left(\frac{8 \times 8}{8 + 8} \right) = 4 \Omega$

(b) 1 A. **Hint—** $I = V/R = 8/(4 + \left(\frac{8 \times 8}{8 + 8} \right)) = 8/8 = 1A$

(c) 4 V. **Hint—** $V = IR = 1 \times 4 = 4 V$

(d) 4 W. **Hint—** $P = I^2 R = 1^2 \times 4 = 4 W$

(e) No difference.

Hint— Same current flows through each element in a series circuit.



CHAPTER 13

ANSWERS

Multiple Choice Questions

1. (c) 2. (c) **Hint**— Only earth's magnetic field will be present.
3. (a) **Hint**— Misconception is that magnetic field lines point from north to south pole. The fact is that they emerge out of North pole and enter into South pole.
4. (c) 5. (a) 6. (c) 7. (d)
8. (d) AC frequency in India is 50 Hz. The direction changes twice in each cycle so that change of direction takes place after every $\frac{1}{100}$ second.
9. (b) 10. (c) 11. (a) 12. (b)

Short Answer Questions

13. In the plane of the paper itself. The axis of the compass is vertical and the field due to the conductor is also vertical. It could result in a dip of compass needle which is not possible in this case (dips result only if axis of compass is horizontal). The deflection is maximum when the conductor through A is perpendicular to the plane of paper and the field due to it is maximum in the plane of the paper.
14. **Hint**— (i) The current through the solenoid should be direct current.
(ii) The rod inside is made of a magnetic material such as steel.
15. **Into** the plane of paper at P and **out** of it at Q. The strength of the magnetic field is larger at the point located closer i.e. at Q.
16. The deflection increases. The strength of magnetic field is directly proportional to the magnitude of current passing through the straight conductor.
17. **Hint**— (i) Yes, Alpha particles being positively charged constitutes a current in the direction of motion. (ii) No. The neutrons being electrically neutral constitute no current.

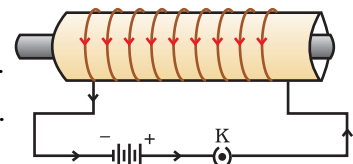

18. The thumb indicates the direction of current in the straight conductor held by curled fingers, whereas the Fleming's left-hand rule gives the direction of force experienced by current carrying conductor placed in an external magnetic field.
19. Strength of the magnetic field falls as distance increases. This is indicated by the decrease in degree of closeness of the lines of field.
20. The divergence, that is, the falling degree of closeness of magnetic field lines indicates the fall in strength of magnetic field near and beyond the ends of the solenoid.
21. Electric fans, mixers, washing machines, computer drives, etc. Motors convert electrical energy into mechanical energy whereas generators convert mechanical energy into electrical energy.
22. The brushes are connected to the battery and touch the outer side of two halves of the split ring whose inner sides are insulated and attached to the axle.
23. Direct current always flows in one direction but the alternating current reverses its direction periodically. The frequency of AC in India is 50 Hz and in each cycle it alters direction twice. Therefore AC changes direction $2 \times 50 = 100$ times in one second.
24. Fuse is used for protecting appliances due to short-circuiting or overloading. The fuse is rated for a certain maximum current and blows off when a current more than the rated value flows through it. If a fuse is replaced by one with larger ratings, the appliances may get damaged while the protecting fuse does not burn off. This practice of using fuse of improper rating should always be avoided.

Long Answer Questions

25. Current carrying loops behave like bar magnets and both have their associated lines of field. This modifies the already existing earth's magnetic field and a deflection results. Magnetic field has both direction and magnitude. Magnetic field lines emerge from N-pole and enter S-pole. The magnetic field strength is represented diagrammatically by the degree of closeness of the field lines. Field lines cannot cross each other as two values of net field at a single point cannot exist. Only one value, a unique net value, can exist. If in a given region, lines of field are shown to be parallel and equi-spaced, the field is understood to be uniform.

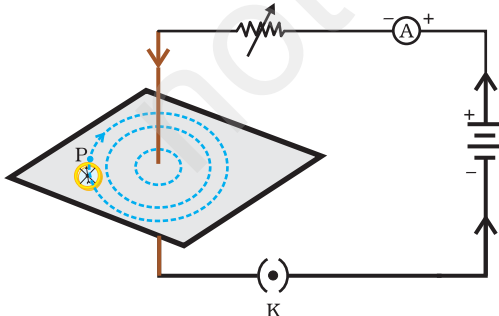

26. Right hand thumb rule states that if a current carrying straight conductor is supposedly held in the right hand with the thumb pointing towards the direction of current, then the fingers will wrap around the conductor in the direction of the field lines of the magnetic field.

27. Hint— The magnetic field at a point is the addition of the field produced by each turn.

28. Hint— Explain the activity with the help of the diagram. According to Fleming's left hand rule, stretch the thumb, forefinger and central finger of your left hand such that they are mutually perpendicular. If the fore finger points in the direction of magnetic field and the central in the direction of current, then the thumb will point in the direction of motion or force acting on the conductor.

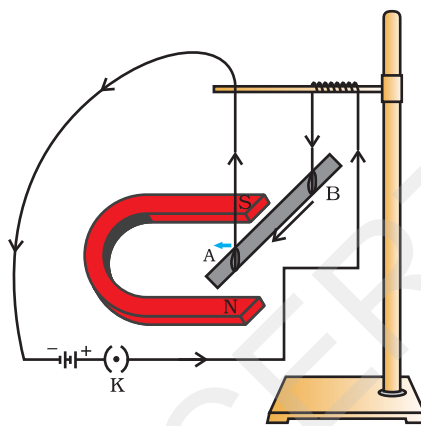
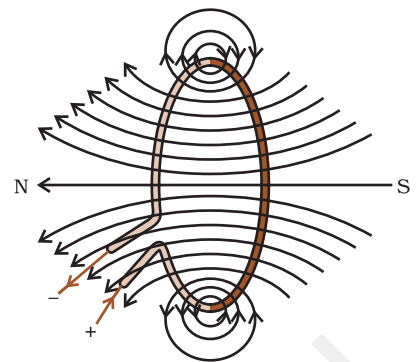

29. Hint— Explain working with the help of the diagram. Commercial motors use an electromagnet in place of a permanent magnet, a large number of turns of conducting wire in the current carrying coil and a soft iron core on which the coil is wound.

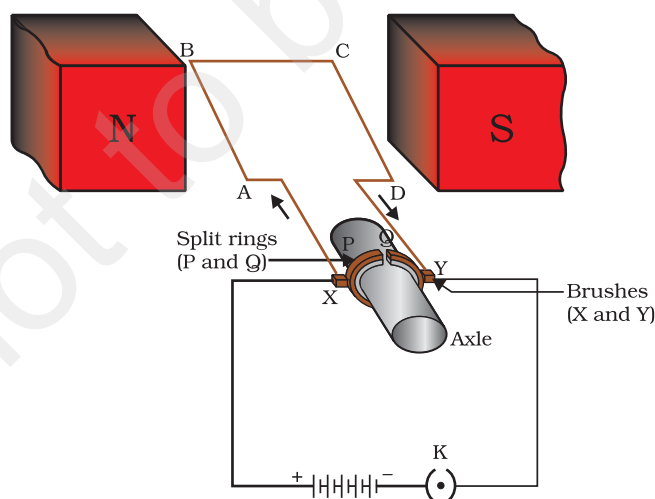

- 30. Hint—** The process by which a changing magnetic field in a conductor induces a current in another conductor is called electromagnetic induction.

Explain the working of the set up with the help of the diagram.

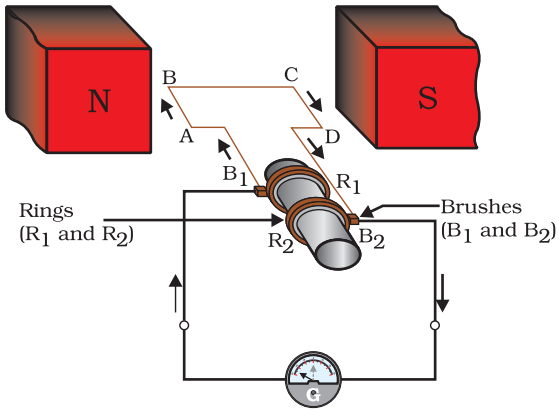
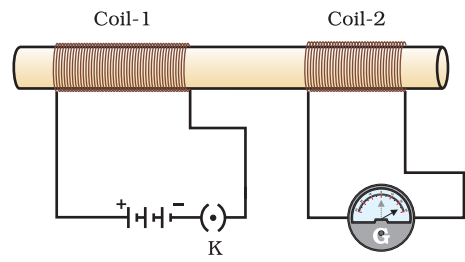

- 31.** Explain working with the help of the diagram. To get a direct current a split ring type commutator must be used in place of slip ring type commutator.

- 32. Hint—**

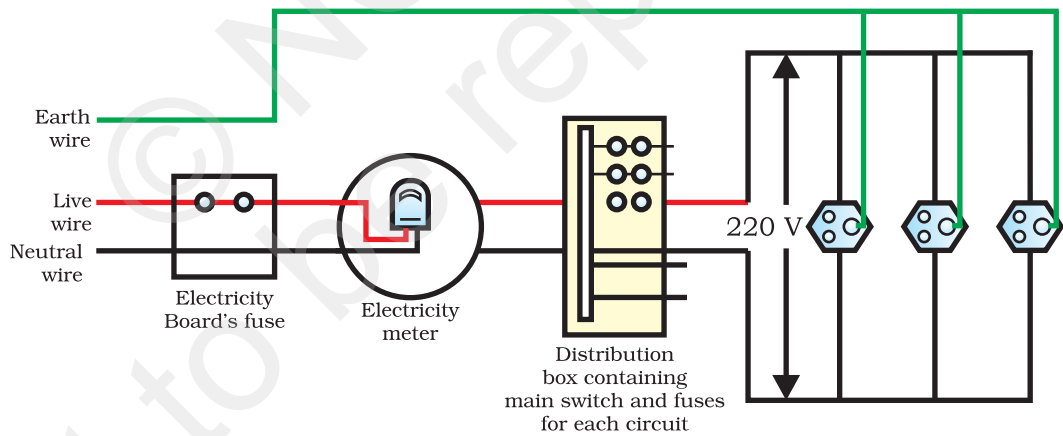

A fuse in a circuit prevents damage to the appliances and the circuit due to overloading. Otherwise the appliances or the circuit may get damaged.

CHAPTER 14

ANSWERS

Multiple Choice Questions

1. (c) 2. (b) 3. (d) 4. (a)
5. (b) 6. (c) 7. (b) 8. (c)
9. (c) 10. (a) 11. (c) 12. (a)
13. (b) 14. (b) 15. (c)

Short Answer Questions

16. **Hint—** (i) Our demand for energy is increasing to improve quality of life and growth of population. (ii) Fossil fuels are limited.
17. **Hint—** Tidal, Wave, OTEC etc.
18. (i) Use of smokeless appliances.
(ii) Afforestation
19. **Hint—** Plane mirror acts as a reflector,
Glass sheet results in green house effect.
20. **Hint—** (i) Solar cells have no moving parts
(ii) Requires little maintenance
(iii) They can be set up in remote areas
21. **Hint—** Biomass: Plant and animal wastes. Explain the working of a biogas plant with a labelled diagram.
22. Because of it being erratic, energy cannot be harnessed continuously. Large areas are required for wind farms.

Long Answer Questions

23. **Hint—** Nuclear Fission. Explanation must include all the steps starting from splitting of uranium nuclei to disposal of nuclear waste.
24. **Hint—** Your answer must include: working of a solar device using reflectors/solar cell. Limitations: Available during day time/sunny

days. Requires huge installations and costly. To overcome limitation: Use of solar cell.

25. Hint— Conventional: Fossil fuels, water, wind, Biomass etc.
Non Conventional: Nuclear, Solar, Energy from ocean, Geothermal etc. Explain the use of one of Non conventional source of energy.

26. Hint— (i) Fossil fuels are depleting, Population is increasing, Quality of life is to be improved etc.

(ii) Tidal/wave/OTEC

27. Hint— Air pollution, Green house effect, Environment consequences: Acid rain, global warming etc. Steps: Use of smokeless appliances, Refined technology, Judicious use of energy etc.

28. Hint— Sun is the ultimate source of energy. Justify by explaining the direct or indirect dependence of different sources of energy on Sun.

29. Hint— Biomass: Plant and animal wastes. Give description of biogas plant with the help of a labelled diagram.



CHAPTER 15

ANSWERS

Multiple Choice Questions

1. (b) 2. (a) 3. (c) 4. (d)
5. (c) 6. (a) 7. (b) 8. (c)
9. (a) 10. (a) 11. (c) 12. (d)
13. (a) 14. (b) 15. (c) 16. (a)
17. (c) 18. (d) 19. (b) 20. (c)
21. (d)

Short Answer Questions

22. Wastes pollute our environment, air, soil and water, and cause harmful effects on all living organisms.
23. Phytoplanktons and aquatic plants → small aquatic animals (larvae, insects etc) → fish → bird
24. Cloth bags are
- (a) capable of carrying more things
 - (b) made of biodegradable material
 - (c) do not pollute our environment
 - (d) can be reused
25. Crop fields are man made and some biotic and abiotic components are manipulated by humans
26. Substances that are broken down into simpler substances by biological processes are said to be biodegradable. Examples, wood, paper.
Substances that cannot be broken down into simpler ones by biological processes are said to be non-biodegradable. Examples, plastic, DDT.
27. (a) Environment/biosphere
(b) Trophic level
(c) Abiotic factors
(d) Consumers/heterotrophs

- 28.** Decomposers break down the dead and decaying organic matter and return the nutrients to the soil. Thus, they play a very important role in the nutrient re-cycling in the environment.
- 29.** (b) Is not a matching pair
Both biotic and abiotic components of environment constitute an ecosystem
- 30.** An aquarium is an artificial and incomplete ecosystem in contrast to a pond/lake which are natural, self-sustaining and complete ecosystems.

Long Answer Questions

- 31.** The flow of energy generally is Sun → producer → herbivore → carnivore. Since the flow is progressively from one trophic level to another and does not revert back, it is said to be unidirectional. Further, the available energy decreases in the higher trophic levels making it impossible for energy to flow in the reverse direction.
- 32.** Decomposers break down the complex organic substances of garbage, dead animals and plants into simpler inorganic substances that go into the soil and are used up again by the plants in the absence of decomposers recycling of material in the biosphere will not take place.
- 33. Hints—** (i) Separation of biodegradable and non-biodegradable substances.
(ii) Gardening
(iii) Use of gunny bags/paper bags in place of polythene/plastic bags
(iv) Use of compost and vermicompost in place of fertilisers
(v) Harvesting rain water

34.

Food chain	Food Web
(a) Food chain is a series of organisms feeding on one another (b) Members of higher trophic level feed upon a single type of organism of the lower trophic level	(a) Food web consists of a number of interlinked food chains. (b) Members of higher trophic level can feed upon organisms of the lower trophic levels of other food chain.

35. Hints— (a) Kitchen wastes

- (b) Paper wastes like newspapers, bags, envelopes
- (c) Plastic bags
- (d) Vegetable/fruit peels/rind

Measures for disposal

- (a) Segregation of biodegradable and non-biodegradable wastes.
- (b) Safe disposal of plastic bags.
- (c) Vegetable/fruit peels can be placed near trees/plants, which on decomposition will enrich the soil with nutrients.
- (d) Give paper wastes for recycling.
- (e) Prepare a compost pit for kitchen wastes.

36. Hints— (a) Control air pollution

- (b) The effluent should be treated before discharge into surrounding environment.

37. The harmful by products are gases such as SO_2 and NO . They cause extensive air pollution and are responsible for acid rain.

38. Hints— (a) Excessive use of fertilisers changes the chemistry of soil and kills useful microbes.

- (b) Excessive use of non-biodegradable chemical pesticides leads to biological magnification.
- (c) Extensive cropping causes loss of soil fertility.
- (d) Excess use of ground water for agriculture lowers the water table.
- (e) Damage to natural ecosystem/habitat.



CHAPTER 16

ANSWERS

Multiple Choice Questions

- | | | | |
|---------|---------|---------|---------|
| 1. (c) | 2. (b) | 3. (b) | 4. (a) |
| 5. (b) | 6. (a) | 7. (d) | 8. (c) |
| 9. (a) | 10. (b) | 11. (d) | 12. (a) |
| 13. (b) | 14. (c) | 15. (c) | 16. (d) |
| 17. (c) | 18. (b) | 19. (a) | 20. (d) |
| 21. (c) | 22. (c) | 23. (d) | 24. (b) |

Short Answer Questions

- 25.** Paper, rexin bag, blade, pen, plastic box, scale, eraser, compass and dividers (metallic), steel lunch box, steel spoon.

Paper, blade, plastic box, eraser, compass, steel lunch box and steel spoon can be recycled

- 26. Hint—** (a) The ground water level increases due to recharging of wells.

(b) Ground water keeps the layers of soil above it moist and prevents loss of water by evaporation.

(c) The water can be stored during rainy season and can be used when required

- 27.** Since people used excessive fertilisers in the fields, they were carried down to the lake during rains. As many fertilisers contain phosphates and nitrates, the water body became enriched with these chemicals. These chemicals promote excessive growth of aquatic plants and the surface of water was completely covered with plants. (eutrophication)

Depletion of light in the water body and insufficient availability of dissolved oxygen and nutrients resulted in the death of fish.

- 28. Hint—**

(a) Put off the fans and lights when they are not required.

(b) Maximum use of solar radiation.

(c) Use of solar water heating system. during winters.

(d) Use of fluorescent tubes or CFL

- 29.** Both the energy sources coal and petroleum take millions of years for their formation. As these resources are being utilised at a much faster rate than their formation, they will be exhausted in the near future, hence they need to be conserved.
- 30. Hint—**
- (a) Reduce the consumption of petrol in the automobiles.
 - (b) Use of CNG or clean fuel
 - (c) Instead of burning litter prepare manure out of it.
 - (d) Treatment of smoke to remove harmful gases before discharging into atmospheric
 - (e) Plant more trees
- 31.** (A) The water reservoir is a pond in Figure 16.1 (a) and underground water body in the Figure 16.1 (b).
- (B) Figure 16.1 (b) has more advantage than Figure 16.1 (a), because the advantages of water stored in the ground are many. For example
- (a) It does not evaporate
 - (b) It spreads out to recharge wells.
 - (c) Provides moisture for vegetation over a wide area.
 - (d) It is protected from contamination by animal and human wastes.
 - (e) It prevents breeding of insects.

Long Answer Questions

- 32. Reduce** means to use a material/commodity in lesser quantity, e.g. electricity and water
- Recycle** means a material that is used once is collected and sent back to a manufacturer so that they can make some other useful material from it
- e.g., plastic cups and buckets, glass tumbler, paper, metal objects
- Reuse** means using a thing over and over again instead of throwing it away. It does not involve the process of recycling either in small or large scale: e.g., used envelopes, plastic carry bags, bottles of jam.
- 33. Hint—**
- (a) Unused water in the water bottle may be used for watering plant
 - (b) Close all the taps before you go to sleep.
 - (c) Avoid using a hose pipe for watering plants
 - (d) Wash vehicles only when they are dirty
 - (e) Use fan and light only when required
 - (f) Use solar water heating devices
 - (g) Use CFL in place of conventional bulbs/tubes

- 34. Hint—** The total amount of fresh water is more than enough to meet the needs of human beings. But due to its uneven distribution, wide seasonal as well as yearly fluctuation in rainfalls and wastage water shortage is a chronic problem in most parts of the world.
- 35. Hint—** Waste water can be used for
- (a) recharging the ground water
 - (b) can be used for irrigation
 - (c) treated municipal water can be used for washing cars, watering the gardens
 - (c) certain pollutants in sewage water can become fertiliser for various crops.
- 36. Hint—** Forests are renewable resources which provide
- (a) Habitat, food, protection to wild life.
 - (b) Help in balancing CO₂ and O₂ of atmosphere.
 - (c) Improves water holding capacity of soil.
 - (d) Regulates water cycle.
 - (e) For human being, they are the source for all essential commodities like, fuel wood, timber pulp and paper etc.
 - (f) It provides useful products like fruits, resins, gums, essential oils, bidi wrapper etc.
- 37. Hint—** The forest department developed a strategy in which the villagers were involved in the protection of the forest. In return for the labour, the villagers were paid and also had some benefit in harvesting operations. They were allowed to collect wood and fodder on payment of nominal fee. In this way, by the active and willing participation of the local people, the sal forests of Arabari were conserved.

